

High quality Series
Ear, Nose and Throat Instruments
耳鼻喉科（精品系列）

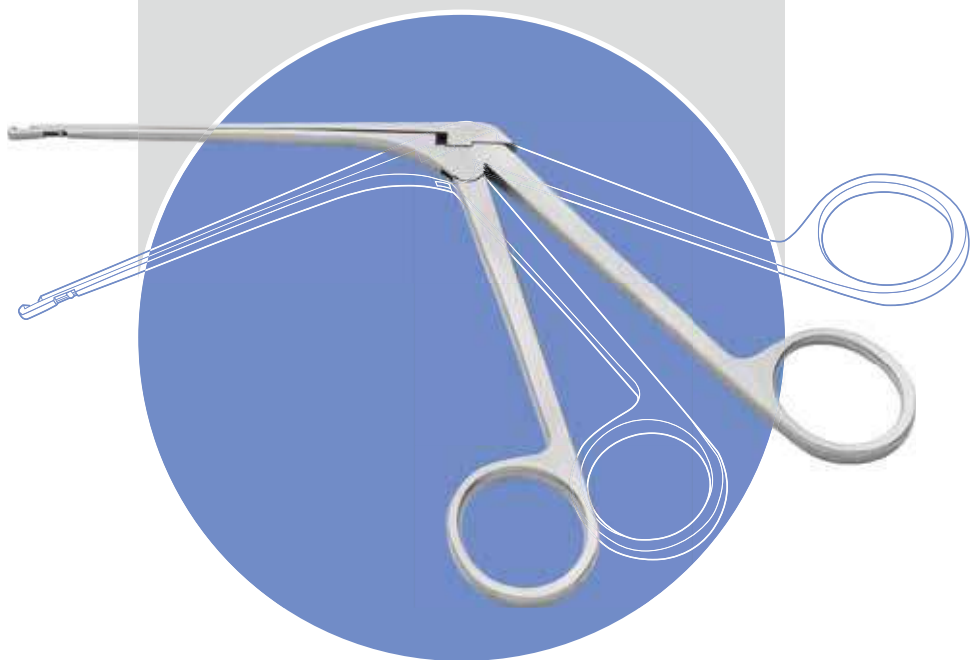

QUALITY
OUR WAY TO SUCCESS

Ear, Nose and Throat Instruments

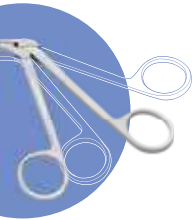
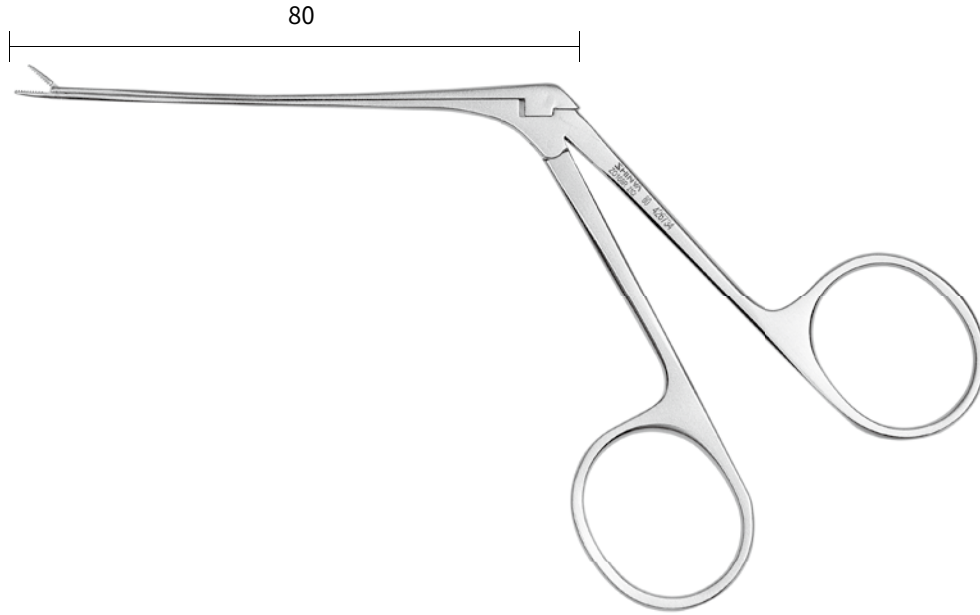

耳
鼻
喉
科
Ear, Nose and Throat Instruments



耳钳 Ear forceps
Z0886R
 80×1.2, 直, 碗形
Z0167R
 80×1.5, 直, 碗形
Z0253R
 80×2, 直, 碗形



耳钳 Ear forceps
Z0887R
 80×1.2×45°, 上弯, 碗形
Z0255R
 80×2.0×45°, 上弯, 碗形
Z0256R
 80×1.5×45°, 上弯, 碗形



耳钳 Ear forceps
Z03919RB
 80×1.2×45°, 下弯, 碗形



耳钳 Ear forceps
Z03917RB
 80×0.5, 直, 橄榄形
Z0166R
 80×0.8, 直, 橄榄形



耳钳 Ear forceps
Z0859R
 80×0.8×45°, 上弯, 橄榄形



耳钳 Ear forceps
Z0860R
 80×0.8×30°, 左弯, 橄榄形
 left curved



耳钳 Ear forceps
Z0861R
 80×0.8×30°, 右弯, 橄榄形
 right curved



耳钳 Ear forceps
Z03918RB
 80×3×30°, 下弯, 麦粒



耳钳 Ear forceps
Z0168R
 80×4, 直, 麦粒形
Z0888R
 80×3, 直, 麦粒形
Z0889R
 80×7, 直, 麦粒形



耳钳 Ear forceps
Z0257R
 80×3×45°, 上弯, 麦粒形



耳钳 Ear forceps
Z0270R
 80×3×30°, 左弯, 麦粒形
 left curved



耳钳 Ear forceps
Z0271R
 80×3×30°, 右弯, 麦粒形
 right curved



耳剪 **Z03820RB**
 80, 直
 ear scissors



耳剪 **Z03821RB**
 80, 左弯
 ear scissors, left curved



耳剪 **Z03822RB**
 80, 右弯
 ear scissors, right curved



耳剪 **Z03883RB**
 80, 上弯
 ear scissors

镫骨足弓剪
Stapes scissors



Z0173R 75 左上翘 left upward angled

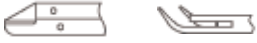

Z0174R 75 右上翘 left upward angled



镫骨钳 (镫骨钳安装钳)
Stapes applying forceps

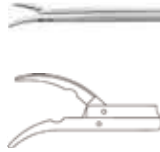

Z0169R 80



镫骨钳
Stapes applying forceps



Z0180R 75



耳用椎骨咬骨剪 (锤骨咬骨剪)
Stapes scissors



Z0181R 80

Z0178R 110

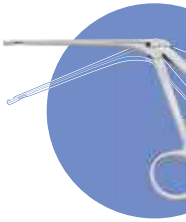

耳鼻喉科
Ear, Nose and Throat Instruments

160

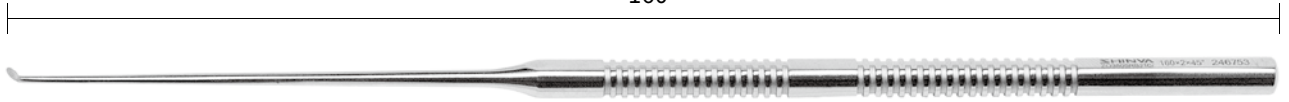

ear hook



显微耳钩
Z03931RB
 160, 弯型, 尖头
 sharp



显微耳钩
Z03930RB
 160, 角弯, 25°, 钝头
 blunt



显微耳钩
Z03929RB
 160, 角弯, 25°, 尖头
 sharp



显微耳钩
Z03928RB
 160×0.4, 直型, 尖头
 sharp



显微耳钩
Z03933RB
 160, 直型, 尖头
 sharp



显微耳钩
Z03934RB
 160×0.6, 直型, 尖头
 sharp



耳钩
Z03935RB
 160×0.4, 直形,
 角弯90°, 钝钩
 sharp



耳钩
Z03921RB
 160×0.6, 直形,
 角弯90°, 钝钩
 sharp



耳钩
Z03936RB
 160×1, 直形,
 角弯90°, 锐钩
 sharp



耳钩
Z03937RB
 160×1.4, 直形,
 角弯90°, 锐钩
 sharp



耳钩
Z03938RB
 160×1.6, 直形,
 角弯90°, 锐钩
 sharp



耳钩
Z03939RB
 160×1.8, 直形,
 角弯90°, 锐钩
 sharp



耳钩
Z03903RB
 165×2, 直形, 锐钩
 sharp



耳钩
Z03965RB
 160×2.5, 直形,
 角弯90°, 锐钩
 sharp



耳钩
Z03966RB
 160×0.8, 直形,
 角弯45°, 锐钩
 sharp



耳钩
Z03922RB
 160×1, 直形,
 角弯45°, 锐钩
 sharp



耳钩
Z03967RB
 160×1.2, 直形,
 角弯45°, 锐钩
 sharp



耳钩
Z03968RB
 160×1.5, 直形,
 角弯45°, 锐钩
 sharp



耳钩
Z03969RB
 160×1.8, 直形,
 角弯45°, 锐钩
 sharp



耳钩
Z03970RB
 160×2, 直形,
 角弯45°, 锐钩
 sharp

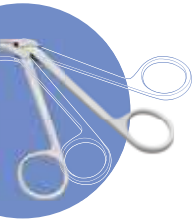

耳鼻喉科
 Ear, Nose and Throat Instruments

160



耳用探针
Z03927RB
 160×0.8, 角弯, 25°, 球头
 ear hook



耳用探针
Z03926RB
 160×0.8, 弯, 球头
 ear hook



耳用探针
Z03977RB
 160×0.8, 直型, 球头
 ear hook



剥离器 dissector
Z03971RB
 160, 1.2×15°, 角弯



剥离器 dissector
Z03925RB
 160, 1.5×15°, 角弯



剥离器 dissector
Z03923RB
 160×1.5, 微弯



剥离器 dissector
Z03972RB
 160×1.8, 弯头



剥离器 dissector
Z03973RB
 160×2, 微弯



剥离器 dissector
Z03974RB
 160×3, 微弯



剥离器 dissector
Z03975RB
 160, 1.2×45°, 左弯, 耳开窗
 left curved



剥离器 dissector
Z03976RB
 160, 1.2×45°, 右弯, 耳开窗
 right curved



剥离器 dissector
Z03924RB
 160, 1.2×70°, 左弯
 left curved



剥离器 dissector
Z03932RB
 160, 1.2×70°, 右弯
 right curved



耳用骨凿 gouge
Z03978RB
 160×2×1.4, 直, 圆刃

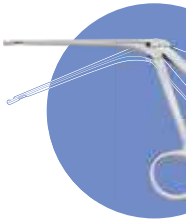

耳鼻喉科
 Ear, Nose and Throat Instruments

160



ear flap knife



耳道皮瓣刀
ZO3801RB
160×1×45°,角弯



耳道皮瓣刀
ZO3802RB
160×1.2×45°,角弯



耳道皮瓣刀
ZO3803RB
160×1.5×45°,角弯



耳道皮瓣刀
ZO3804RB
160×1.8×45°,角弯



耳道皮瓣刀
ZO3805RB
160×2×45°,角弯



耳道皮瓣刀
ZO3806RB
160×2.5×45°,角弯



耳道皮瓣刀
ZO3807RB
160×3×45°,角弯



耳道皮瓣刀
ZO3808RB
160×1×90°,角弯



耳道皮瓣刀
ZO3809RB
160×1.2×90°,角弯



耳道皮瓣刀
ZO3810RB
160×1.5×90°,角弯



耳道皮瓣刀
ZO3811RB
160×1.8×90°,角弯



耳道皮瓣刀
ZO3812RB
160×2×90°,角弯



耳道皮瓣刀
ZO3813RB
160×2.5×90°,角弯



耳道皮瓣刀
ZO3814RB
160×2,直型



耳道皮瓣刀
ZO3815RB
160×2.5,直型



耳道皮瓣刀
ZO3816RB
160,镰状



耳道皮瓣刀
ZO3817RB
160,镰状

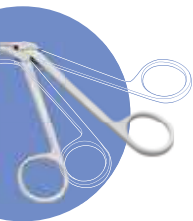

耳鼻喉科

Ear, Nose and Throat Instruments

75

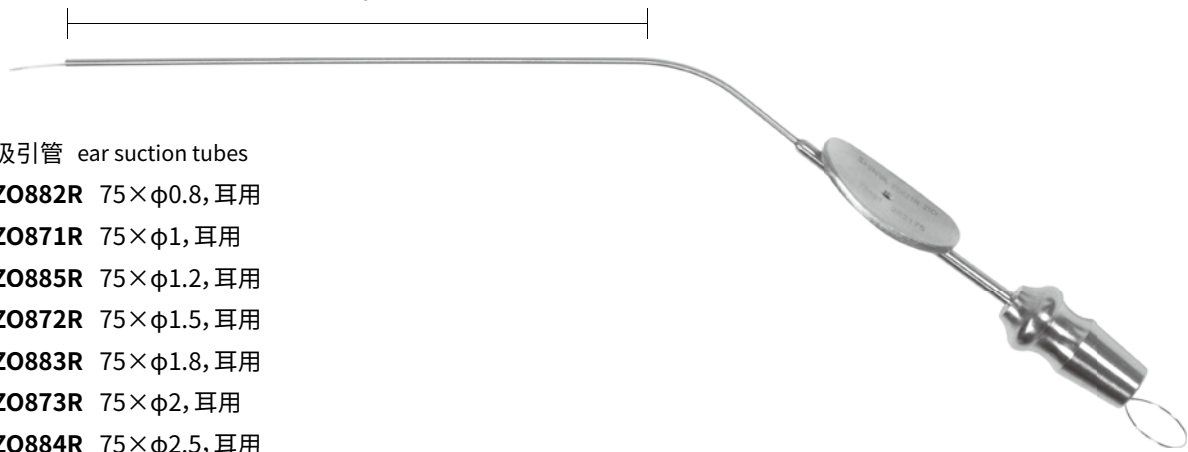

- 吸引管 ear suction tubes
- ZO882R** 75×φ0.8,耳用
 - ZO871R** 75×φ1,耳用
 - ZO885R** 75×φ1.2,耳用
 - ZO872R** 75×φ1.5,耳用
 - ZO883R** 75×φ1.8,耳用
 - ZO873R** 75×φ2,耳用
 - ZO884R** 75×φ2.5,耳用



耳用叉 ear fork

ZO3819RN 200, T型, 于宾格、美敦力T型管通用

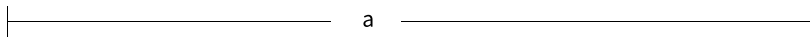

nasal tissue forceps

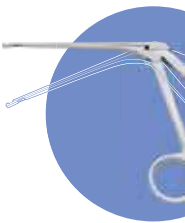

耳鼻喉科
 Ear, Nose and Throat Instruments



鼻组织钳 a
ZO3701RB 160×3.2,
 管式, 直, 尖头



鼻组织钳 a
ZO3702RB 160×3.2×45°,
 管式, 角弯, 尖头



鼻组织钳 a
ZO3640RB 130×3.5,
 管式, 直, 尖头



鼻组织钳 a
ZO3641RB 130×3.5×30°,
 管式, 角弯, 尖头



鼻组织钳 a
ZO3642RB 130×3.5×45°,
 管式, 角弯, 尖头

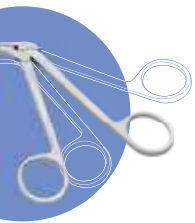

耳鼻喉科
 Ear, Nose and Throat Instruments

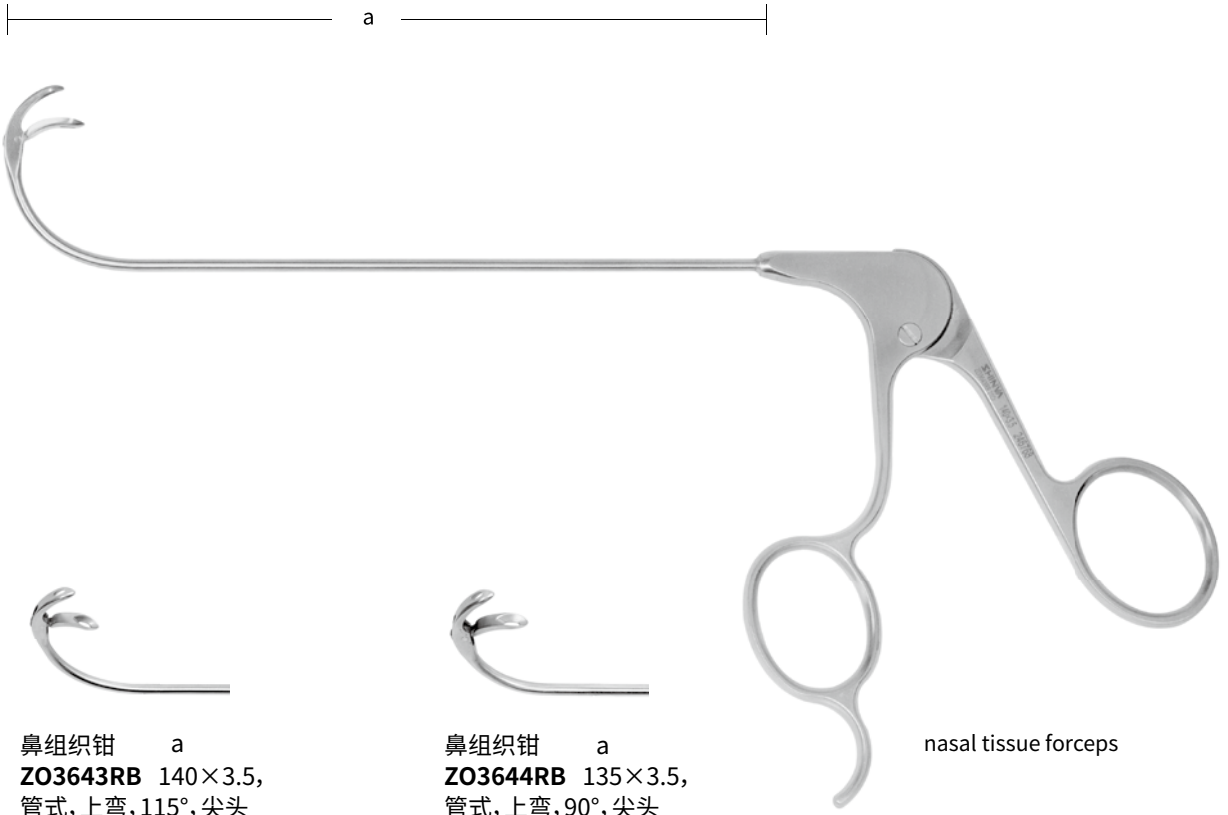

鼻组织钳 a
ZO3643RB 140×3.5,
 管式, 上弯, 115°, 尖头

鼻组织钳 a
ZO3644RB 135×3.5,
 管式, 上弯, 90°, 尖头

鼻组织钳 a
ZO3645RB 140×3.5,
 管式, 下弯, 115°, 尖头

鼻组织钳 a
ZO3646RB 135×3.5,
 管式, 下弯, 90°, 尖头

鼻咬切钳 a
ZF3010RB 180×φ3.5,
 直形, 蝶窦口
 nasal cutting forceps

鼻咬切钳 a
ZF3012RB 170×φ3.5×65°,
 蝶窦口
 nasal cutting forceps

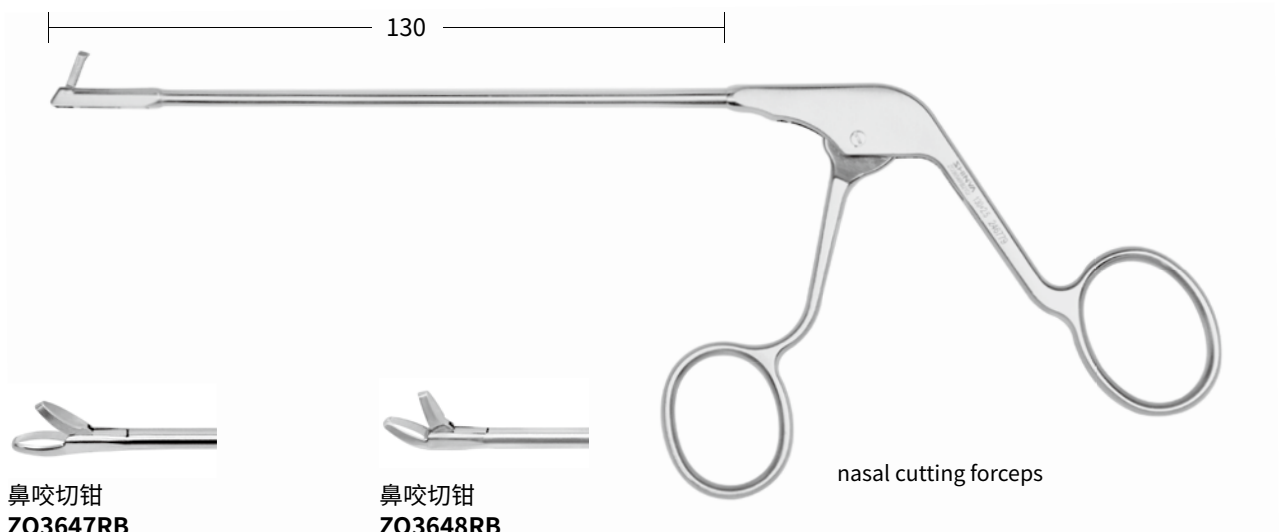

鼻咬切钳
ZO3647RB
 130×3,
 管式,直型,尖头

鼻咬切钳
ZO3648RB
 130×3×30°,
 管式,角弯,尖头



鼻咬切钳
ZO3649RB
 130×3×45°,
 管式,角弯,尖头



鼻咬切钳
ZO3650RB
 130×3,
 管式,直型,长圆头



鼻咬切钳
ZO3651RB
 130×3×30°,
 管式,角弯,长圆头



鼻咬切钳
ZO3652RB
 130×3×45°,
 管式,角弯,长圆头



鼻咬切钳
ZO3653RB
 130×1.8,
 管式,直型,反切



鼻咬切钳
ZO3654RB
 130×2.5,
 管式,直型,反切



鼻组织剪
ZO3655RB
 130,直形,管式
 nasal tissue scissors



鼻组织剪
ZO3656RB
 130,左弯,管式
 nasal tissue scissors
 left curved



鼻组织剪
ZO3657RB
 130,右弯,管式
 nasal tissue scissors
 right curved

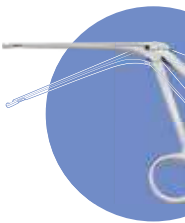

耳鼻喉科
 Ear, Nose and Throat Instruments



蝶窦咬骨钳
Z03944RB
 170×70°×3
 nasal cutting forceps



蝶窦咬骨钳
Z03943RB
 170×30°×3
 nasal cutting forceps

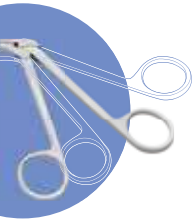

耳鼻喉科
 Ear, Nose and Throat Instruments

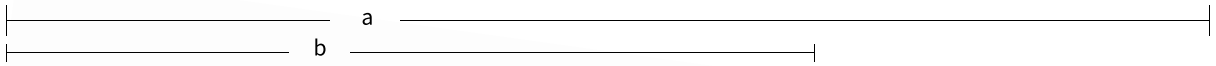

鼻腔吸引管 (门诊治疗台专用)
 suction tube for outpatient use

	a	b
Z01280RB	155×Φ1.5×30°×55	工作长度 100
Z01281RB	155×Φ2×30°×55	工作长度 100
Z01282RB	155×Φ2.5×30°×55	工作长度 100
Z01283RB	155×Φ3×30°×55	工作长度 100
Z01284RB	155×Φ3.5×30°×55	工作长度 100

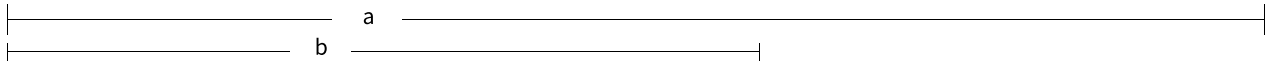

鼻腔吸引管
 suction tube

	a	b
Z03835RB	170×Φ2.5	工作长度 110
Z03836RB	170×Φ3	工作长度 110
Z03837RB	170×Φ3.5	工作长度 110



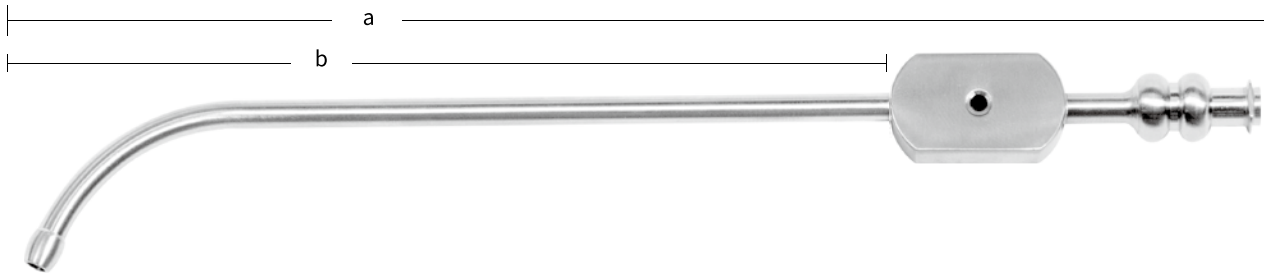

鼻腔吸引管
suction tube

	a		b		a		b
ZO3838RB	175×φ2.5×60°	平口	工作长度 120		ZO3839RB	175×φ3×60°	平口 工作长度 120
ZO3840RB	175×φ3.5×60°	平口	工作长度 120		ZO3841RB	175×φ4×60°	平口 工作长度 120

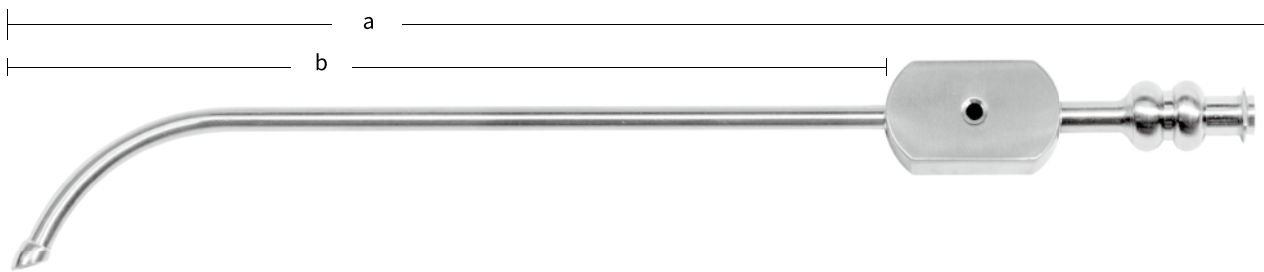

鼻腔吸引管
suction tube

	a		b		a		b
ZO3842RB	175×φ2.5×60°	斜口	工作长度 120		ZO3843RB	175×φ3×60°	斜口 工作长度 120
ZO3844RB	175×φ3.5×60°	斜口	工作长度 120		ZO3845RB	175×φ4×60°	斜口 工作长度 120

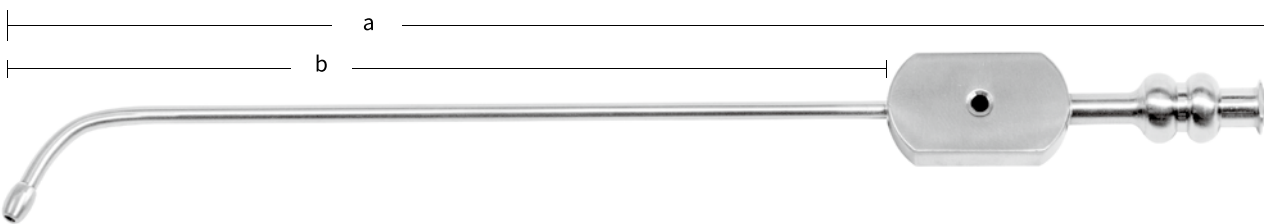

鼻腔吸引管
suction tube

	a		b		a		b
ZO3858RB	175×φ2.5×70°	平口	工作长度 120		ZO3859RB	175×φ3×70°	平口 工作长度 120
ZO3860RB	175×φ3.5×70°	平口	工作长度 120		ZO3861RB	175×φ4×70°	平口 工作长度 120

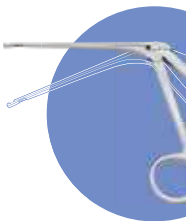

耳鼻喉科
Ear, Nose and Throat Instruments



鼻腔吸引管
 suction tube

	a		b
ZO3862RB	175×φ2.5×90°	平口	工作长度 120
ZO3863RB	175×φ3×90°	平口	工作长度 120
ZO3864RB	175×φ3.5×90°	平口	工作长度 120
ZO3865RB	175×φ4×90°	平口	工作长度 120

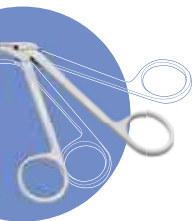

耳鼻喉科
 Ear, Nose and Throat Instruments



剥离器
 dissector with suction connector

ZO3866RB	200×3, 单面孔, 带吸引, 旋转, 45°
ZO3867RB	200×3.8, 单面孔, 带吸引, 旋转, 45°



剥离器
 dissector with suction connector

ZO3868RB	200×3, 单面孔, 带吸引, 旋转, 0°
ZO3869RB	200×3.8, 单面孔, 带吸引, 旋转, 0°



剥离器
dissector with suction

ZO628RN 215×2.5×45°, 带吸引

ZO1020RN 215×2.5×60°, 带吸引

ZO1019RN 215×2.5×90°, 带吸引



鼻腔拉钩(鼻腔异物钩圈)
nasal foreign body retractor

ZO629RN 180, 双头



上颌窦探针
nasal probe

ZO439RN 190×1×2, 角弯



上颌窦探针
nasal probe

ZO627RN 210×1.5×1.5, 角弯

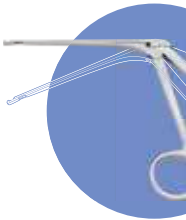

耳鼻喉科
Ear, Nose and Throat Instruments

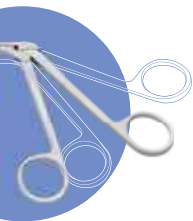

耳鼻咽喉科
 Ear, Nose and Throat Instruments



显微喉钳
 Laryngeal forceps



显微喉钳
JO1180RB
 230×φ2, 管式,
 直型, 圆头



显微喉钳
JO1181RB
 230×φ2, 管式,
 上弯, 圆头



显微喉钳
JO1182RB
 230×φ2, 管式,
 右弯, 圆头 Right curved



显微喉钳
JO1183RB
 230×φ2, 管式,
 左弯, 圆头 left curved



显微喉钳
JO1184RB
 230×1, 管式,
 直型, 麦粒形



显微喉钳
JO1185RB
 230×1, 管式,
 右弯, 麦粒形 Right curved



显微喉钳
JO1186RB
 230×1, 管式,
 左弯, 麦粒形 Left curved



显微喉钳
JO1187RB
 230×1, 管式,
 上弯, 麦粒形



显微喉钳
JO1188RB
 230×3, 管式, 角弯,
 右弯, 抓取型 Right curved
JO1189RB
 230×2, 管式, 角弯,
 右弯, 抓取型 Right curved



显微喉钳
JO1190RB
 230×3, 管式, 角弯,
 左弯, 抓取型 Left curved
JO1191RB
 230×2, 管式, 角弯,
 左弯, 抓取型 Left curved



显微持针钳
JO1192RB
 230, 直型, 自锁
 Needle holder, self-locking



显微喉剪
 laryngeal scissors
JO1249RB
 230, 管式, 直型



显微喉剪
 laryngeal scissors
JO1250RB
 230×45°, 管式, 上弯



显微喉剪
 laryngeal scissors
JO1251RB
 230×15°, 管式, 上弯



显微喉剪
 laryngeal scissors
JO1252RB
 230, 管式, 右弯
 right curved



显微喉剪
 laryngeal scissors
JO1253RB
 230, 管式, 左弯
 left curved



显微喉钳
Laryngeal forceps



显微喉钳
ZO3823RB
230×φ2, 管式, 直型, 圆头



显微喉钳
ZO3824RB
230×φ2, 管式, 上弯, 圆头



显微喉钳
ZO3825RB
230×φ2, 管式, 左弯, 圆头
left curved



显微喉钳
ZO3826RB
230×φ2, 管式, 右弯, 圆头
right curved



显微喉钳
ZO3827RB
230×2, 管式, 直型, 有齿



显微喉钳
ZO3828RB
230×2, 管式, 上弯, 45°, 有齿



显微喉钳
ZO3829RB
230×2, 管式, 直型, 三角头



显微喉钳
ZO3830RB
230×2, 管式, 上弯, 45°, 三角头



显微喉钳
ZO3831RB
230×2, 管式, 直型, 卵圆头



显微喉钳
ZO3832RB
230×2, 管式, 上弯, 卵圆头



显微喉钳
ZO3833RB
230×2, 管式, 左弯, 卵圆头
left curved



显微喉钳
ZO3834RB
230×2, 管式, 右弯, 卵圆头
right curved



显微喉剪
laryngeal scissors
ZO1241RB
250×φ2, 管式, 直型
laryngeal scissors



显微喉剪
laryngeal scissors
ZO1242RB
250×φ2, 管式, 上弯45°



显微喉剪
laryngeal scissors
ZO1243RB
250×φ2, 管式, 右弯
right curved



显微喉剪
laryngeal scissors
ZO1244RB
250×φ2, 管式, 左弯
left curved

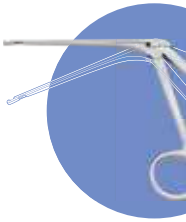

耳鼻喉科
Ear, Nose and Throat Instruments



支撑喉镜支撑架
Laryngoscope frame
Z01227RN 支撑架

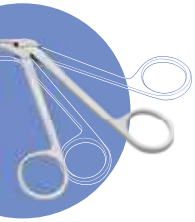

耳鼻喉科
Ear, Nose and Throat Instruments



支撑喉镜支撑架
Laryngoscope frame
Z01201RN 支撑架



支撑喉镜
Laryngoscope

ZO1228RN 大号, 带光纤 Large with optical fiber

ZO1229RN 小号, 带光纤 Small with optical fiber



支撑喉镜
Laryngoscope

ZO1202RN 大号 Large

ZO1203RN 小号 Small



支撑喉镜灯芯
Light insert for laryngoscope

ZO1221RN 带光纤 With optical fiber

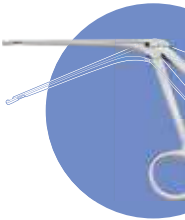

耳鼻喉科
Ear, Nose and Throat Instruments

支撑喉镜

Laryngoscope, adjustable

ZO1224RN 可调式

该产品为可调式支撑喉镜,由支撑架、喉镜、灯芯组成,供耳鼻喉科医生检查和治疗喉内病变。可调式支撑喉镜在使用过程中可以通过调节旋转手柄实现喉镜在支撑杆方向上的移动以及喉镜张口的调整,从而灵活的根据手术情况调整手术视野,方便医生操作。

Consists of frame, laryngoscope and light insert for ENT surgeons to check and make disease treatment. Laryngoscope and its opening can be moved and adjusted through adjusting the handle according to surgical requirement.

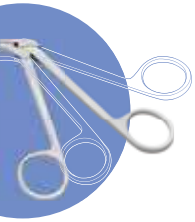

耳鼻喉科
Ear, Nose and Throat Instruments



显微喉刀 **ZO3846RB**
245, 直形, 镰刀
laryngeal knife



显微喉刀 **ZO3847RB**
245, 直形, 三角刃
laryngeal knife



显微喉刀 **ZO3848RB**
245, 直形, 圆刃
laryngeal knife



显微喉刀 **ZO3849RB**
245, 角弯, 圆刃
laryngeal knife



显微喉刀 **ZO3850RB**
245, 直形, 圆刃
laryngeal knife



显微喉钩 **ZO3851RB**
245, 圆弯
laryngeal hook



显微剥离器 **ZO3852RB**
245, 圆头, 微弯
laryngeal dissector



打结器 **ZO3853RB**
245
knot pusher



显微喉针 **ZO3854RB**
245, 直型, 球头
laryngeal needle



显微喉针 **ZO3855RB**
245, 角弯, 45°, 球头
laryngeal needle



显微喉针 **ZO3856RB**
245, 角弯, 90°, 球头
laryngeal needle



handle
喉显微手术器械手柄
ZO3857RB 与喉钩、
喉刀、喉针配用, 可换

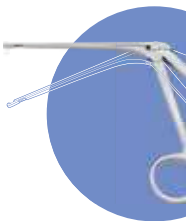

耳鼻喉科
Ear, Nose and Throat Instruments

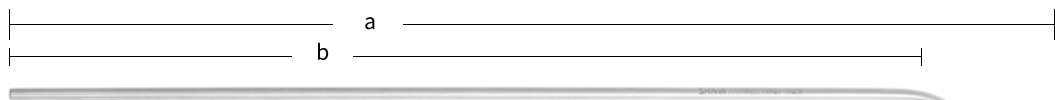

吸引管
suction tube

	a		b
ZO3870RN	250×Φ2.5, 弯, 喉用, 可控	工作长度	205
ZO1270RN	250×Φ3, 弯, 喉用, 可控	工作长度	205
ZO1271RN	250×Φ3.5, 弯, 喉用, 可控	工作长度	205
ZO1272RN	250×Φ4, 弯, 喉用, 可控	工作长度	205

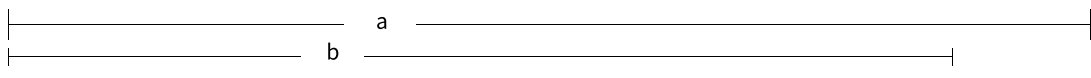

吸引管
suction tube

	a		b
ZO1276RN	275×Φ2.5, 弯, 喉用, 可控	工作长度	230
ZO1277RN	275×Φ3, 弯, 喉用, 可控	工作长度	230
ZO1278RN	275×Φ3.5, 弯, 喉用, 可控	工作长度	230
ZO1279RN	275×Φ4, 弯, 喉用, 可控	工作长度	230

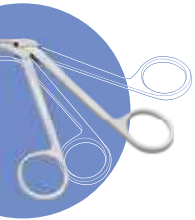

耳鼻咽喉科
 Ear, Nose and Throat Instruments

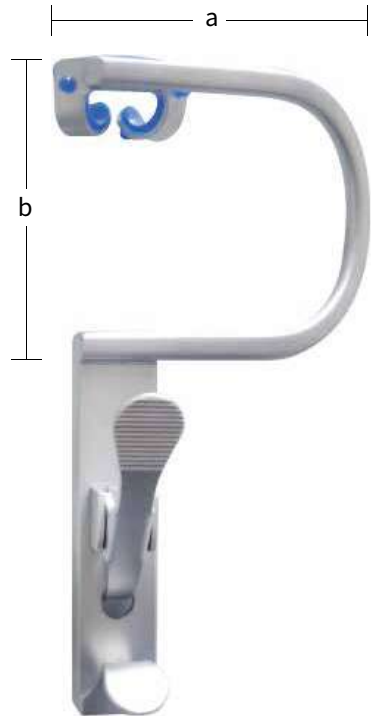

口腔开口器 (成套)
 mouth gag(set)

		a	b	
ZR828N	左式, 麻醉, 成人	85	78	left, for adult
ZR826N	左式, 麻醉, 小儿	78	71	left, for Children

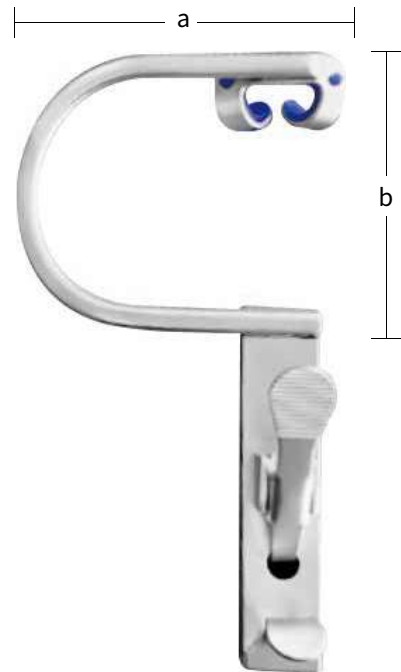

口腔开口器 (成套)
 mouth gag(set)

		a	b	
ZR827N	右式, 麻醉, 成人	85	78	right, for adult
ZR829N	右式, 麻醉, 小儿	78	71	right, for Children

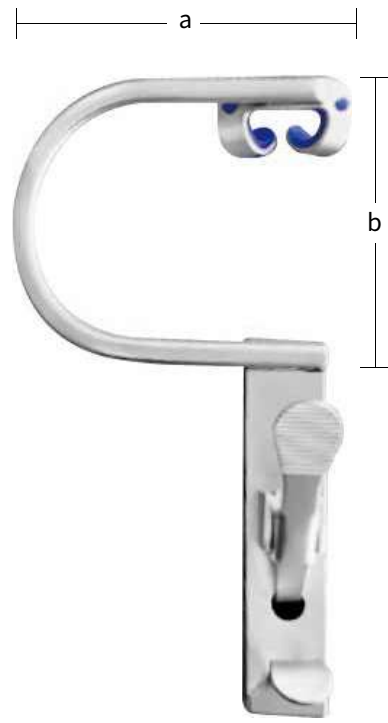
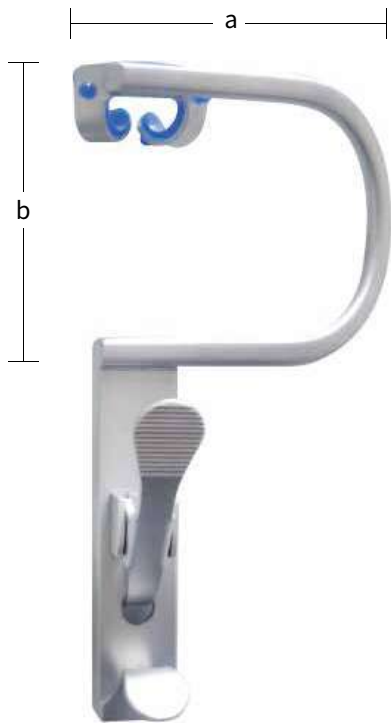

口腔开口器 (框架)

mouth gag(set)

	a	b	
ZR824N 左式, 麻醉, 成人	85	78	left, for adult
ZR839N 左式, 麻醉, 小儿	78	71	left, for Children

口腔开口器 (框架)

mouth gag(set)

	a	b	
ZR825N 右式, 麻醉, 成人	85	78	right, for adult
ZR840N 右式, 麻醉, 小儿	78	71	right, for Children



耳鼻喉科
 Ear, Nose and Throat Instruments



口腔开口器

mouth gag

ZR819RN 右式, 麻醉 right

口腔开口器

mouth gag

ZR820RN 左式, 麻醉 left

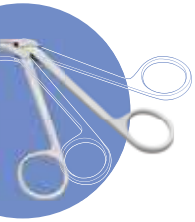

耳鼻喉科
Ear, Nose and Throat Instruments

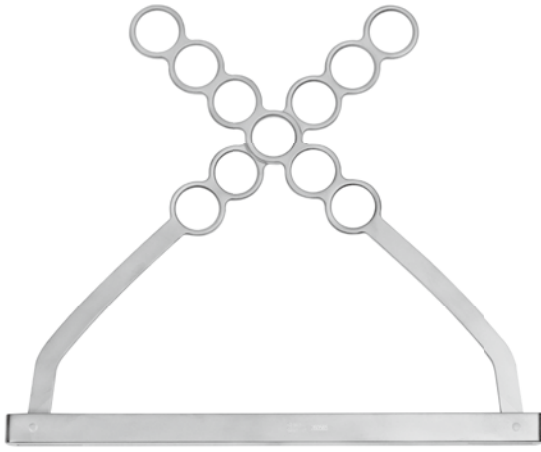

口腔开口器
Mouth gag support
ZR817T 开口器支架



口腔开口器
Mouth gag
ZR823RN 框式



口腔开口器
Mouth gag
ZR818RN 框式

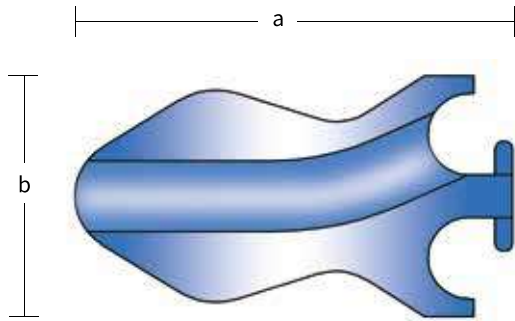

拉钩 retractor		a	b
ZR830RN 口腔	1#	深度62mm	宽度30mm
	2#	深度74mm	宽度34mm
	3#	深度78mm	宽度36mm

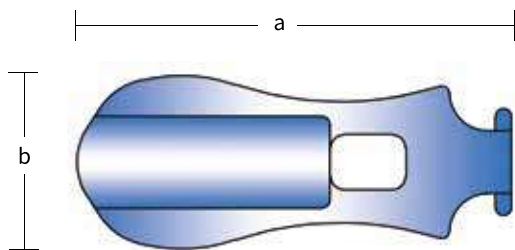

拉钩 retractor		a	b
ZR831RN 口腔	1#	深度63mm	宽度25mm
	2#	深度67mm	宽度30mm
	3#	深度80mm	宽度34mm

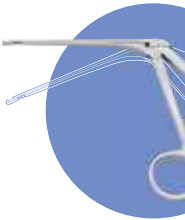
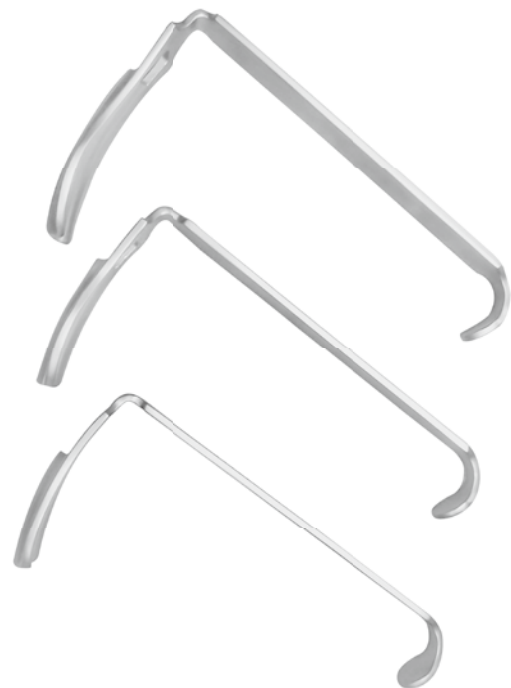

耳鼻喉科
 Ear, Nose and Throat Instruments

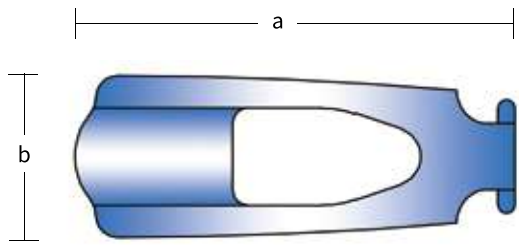

拉钩 retractor	a	b
ZR832RN 口腔	1# 深度60mm	宽度22mm
	2# 深度70mm	宽度26mm
	3# 深度80mm	宽度30mm
	4# 深度90mm	宽度32mm
	5# 深度100mm	宽度35mm

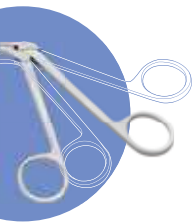

耳鼻喉科
 Ear, Nose and Throat Instruments

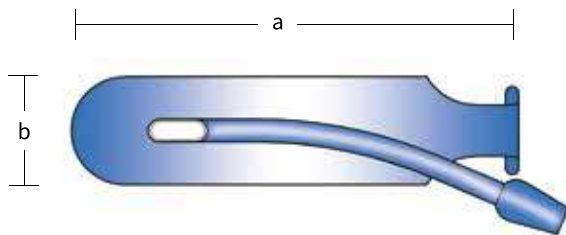

拉钩 retractor	a	b
ZR834RN 口腔	1# 深度40mm	宽度18mm
	2# 深度79mm	宽度19mm
	3# 深度85mm	宽度25mm
	4# 深度90mm	宽度25mm
	5# 深度96mm	宽度25mm



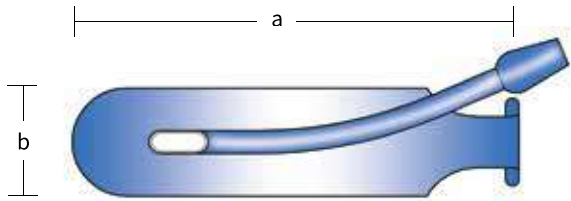

拉钩 retractor	a	b
ZR835RN 口腔	1# 深度40mm	宽度18mm
	2# 深度79mm	宽度19mm
	3# 深度85mm	宽度25mm
	4# 深度90mm	宽度25mm
	5# 深度96mm	宽度25mm

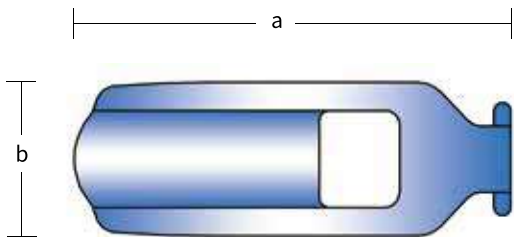

拉钩 retractor	a	b
ZR836RN 口腔	1# 深度60mm	宽度21mm
	2# 深度70mm	宽度25mm
	3# 深度80mm	宽度27mm
	4# 深度90mm	宽度29mm
	5# 深度50mm	宽度21mm

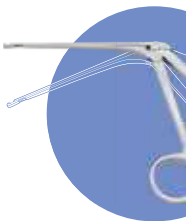

耳鼻喉科
 Ear, Nose and Throat Instruments

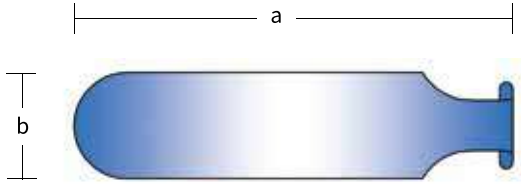

拉钩 retractor	a	b
ZR837RN 口腔	1# 深度40mm	宽度18mm
	2# 深度79mm	宽度19mm
	3# 深度85mm	宽度25mm
	4# 深度90mm	宽度25mm
	5# 深度96mm	宽度25mm

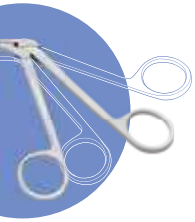
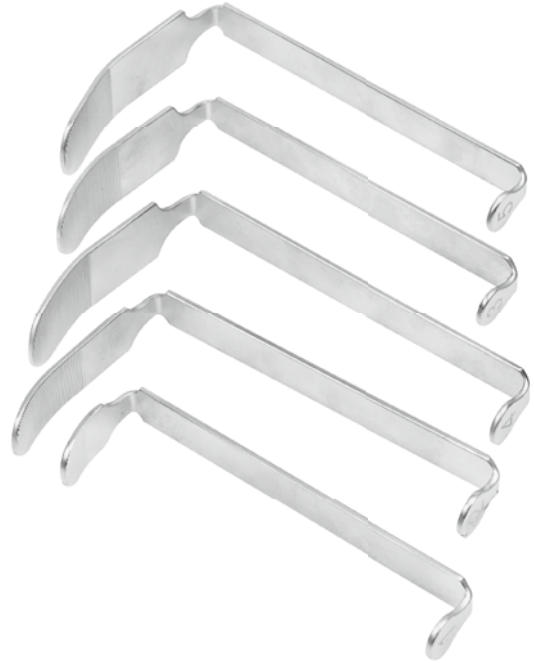

耳鼻喉科
 Ear, Nose and Throat Instruments

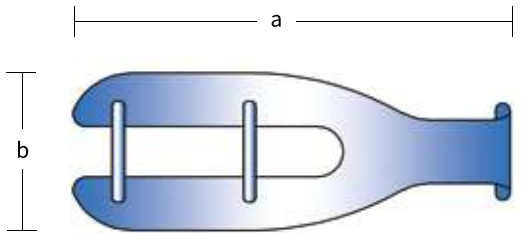

拉钩 retractor	a	b
ZR838RN 口腔	1# 深度70mm	宽度25mm
	2# 深度80mm	宽度26mm
	3# 深度90mm	宽度26mm
	4# 深度100mm	宽度26mm

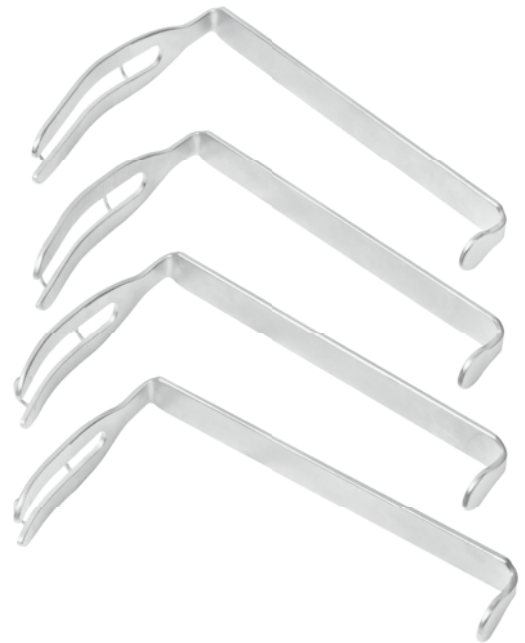

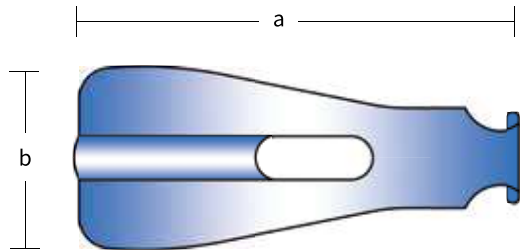

拉钩 retractor	a	b
ZR841RN 口腔	1# 深度110mm	宽度38mm
	2# 深度100mm	宽度37mm
	3# 深度90mm	宽度37mm
	4# 深度80mm	宽度32mm
	5# 深度70mm	宽度30mm

拉钩 retractor	a	b
ZR842RN 口腔	3# 深度90mm	宽度37mm
	4# 深度80mm	宽度32mm
	5# 深度70mm	宽度30mm
	6# 深度70mm	宽度25mm
	7# 深度60mm	宽度22mm

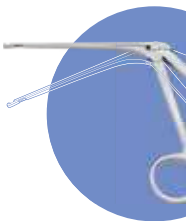

耳鼻喉科
 Ear, Nose and Throat Instruments

Normal quality Series
Ear, Nose and Throat Instruments
耳鼻喉科（普通系列）

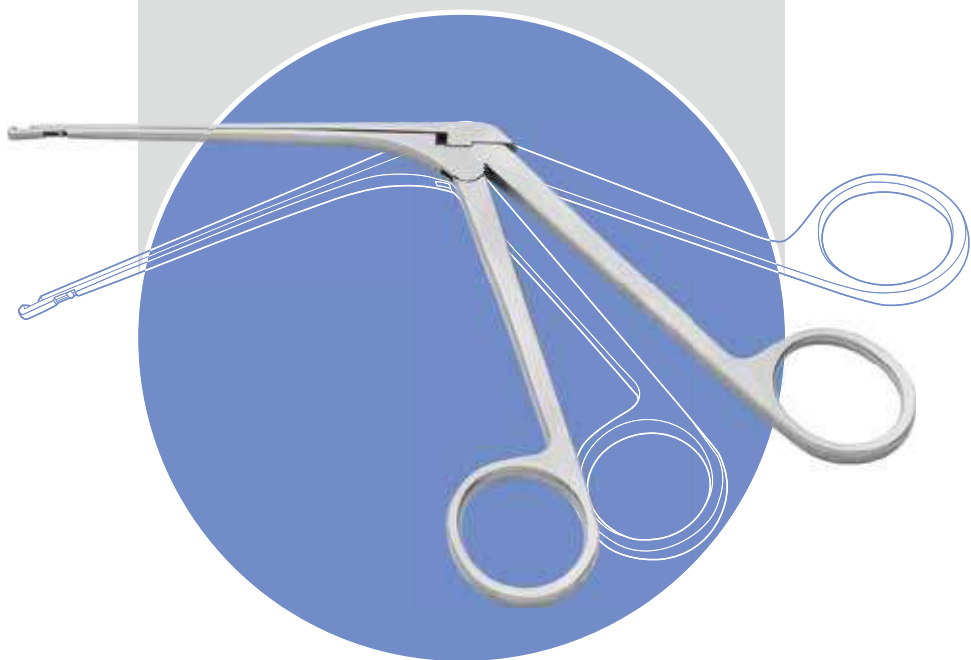

QUALITY
OUR WAY TO SUCCESS

Ear, Nose and Throat Instruments

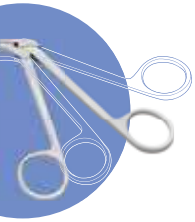

耳鼻喉科
 Ear, Nose and Throat Instruments



听觉检查音叉
 Tuning fork

- ★ **ZO297R**
128HZ, 有套环
- ★ **ZO298R**
256HZ, 有套环



听觉检查音叉
 Tuning fork

- ★ **ZO299R**
512HZ, 无套环
- ★ **ZO300R**
1024HZ, 无套环
- ★ **ZO301R**
2048HZ, 无套环



耳镜
 Otoscope

ZO3980R 光纤 Optical Fiber

耳鼓膜刀 (鼓膜刀)
 Myringa knife, angled curved

- ★ **ZO108RN**
170角弯三角刃



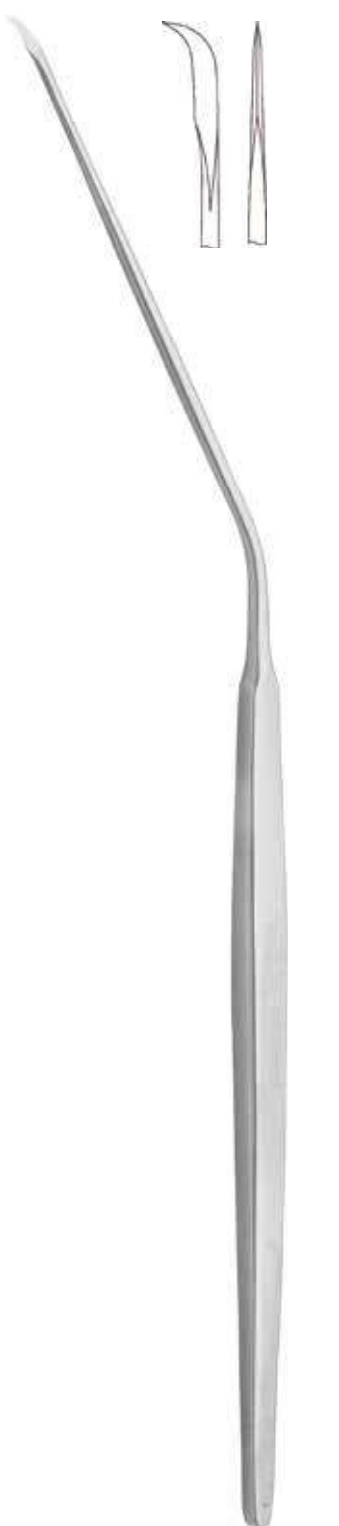

耳鼓膜刀 (鼓膜刀)
 Myringa knife, angled curved

★ **ZO109RN**
 170角弯半月刃



耳鼓膜刀 (鼓膜刀)
 Myringa knife, bayonet-shaped

ZO110RN
 190枪形三角刃

ZO111RN
 190枪形半月刃



耳刮匙 (乳突刮匙)
 Mastoid curette

- ★ **ZO155R** 160×1.5
- ★ **ZO156R** 160×2
- ★ **ZO157R** 160×2.5
- ★ **ZO158R** 160×3
- ★ **ZO159R** 160×3.5
- ZO160R** 160×4
- ZO241R** 160×4.5
- ZO161R** 160×5
- ZO162R** 160×5.5
- ZO163R** 160×6



耳刮匙
 Ear curette

ZO320R
 160×1.0, 直, 单头, 圆头

ZO321R
 160×1.5, 直, 单头, 圆头

★ **ZO184R**
 160×1.8 圆头

★ **ZO185R**
 160×2 圆头
 Straight, round tip

★ **ZO152R**
 160×2 单头椭圆
 Straight, oval tip

ZO322R
 160×1.2, 微弯, 单头, 椭圆头

ZO323R
 160×1.5, 微弯, 单头, 椭圆头
 Slightly curved, oval tip

ZO324R
 160×1.2, 弯, 单头, 椭圆头

ZO325R
 160×1.5, 弯, 单头, 椭圆头
 Curved, oval tip



耳鼻喉科
 Ear, Nose and Throat Instruments

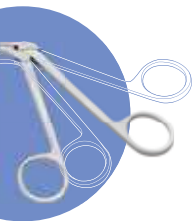

耳鼻咽喉科
 Ear, Nose and Throat Instruments

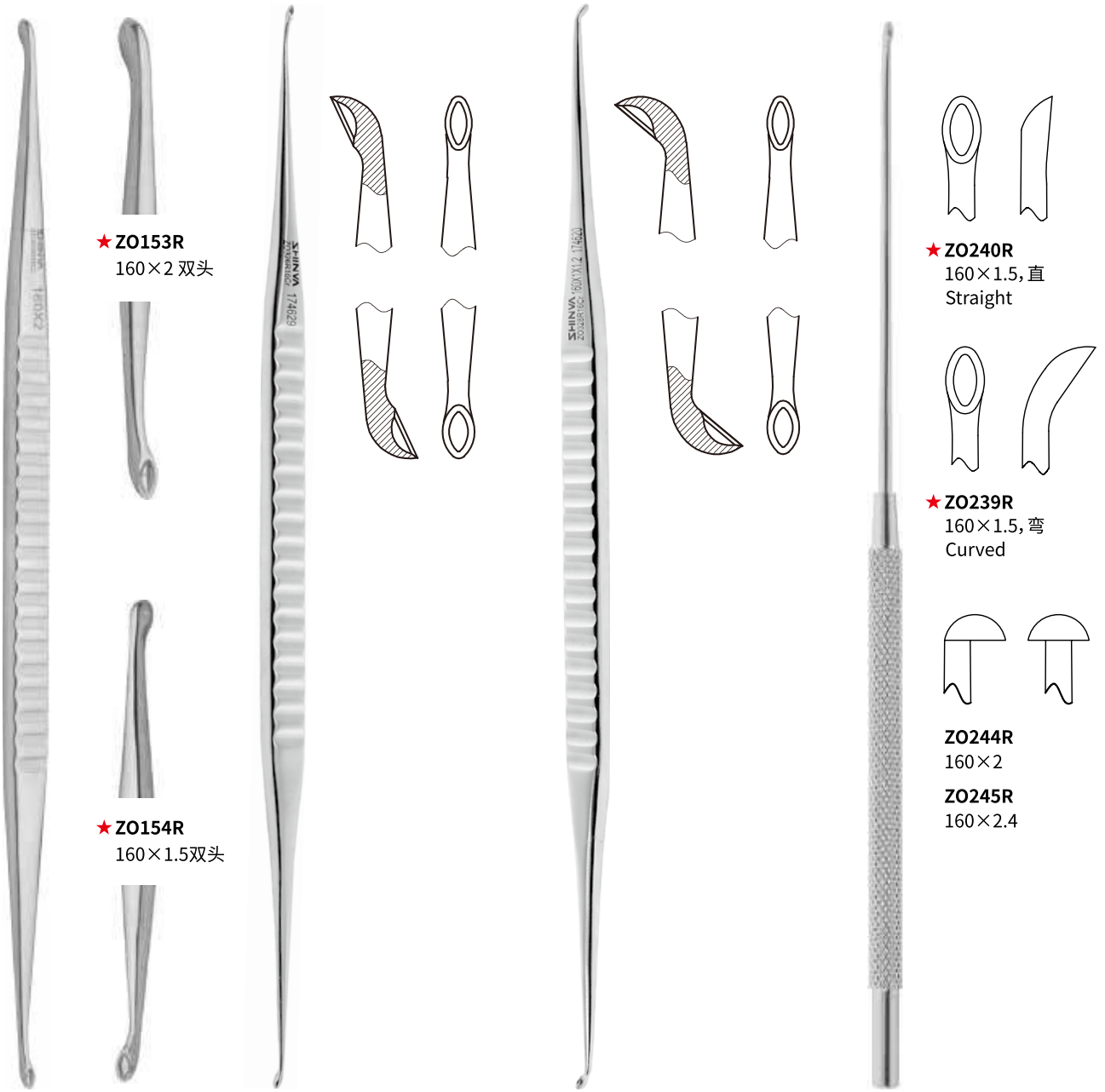

耳刮匙
 Ear curette, double ended

耳刮匙
 Ear curette slightly curved, oval tip

耳刮匙
 Ear curette curved, oval tip

耳刮匙
 Ear curette

- Z0326R**
 160×1.0×1.2, 微弯, 双头, 椭圆头
- Z0327R**
 160×1.5×1.8, 微弯, 双头, 椭圆头

- Z0328R**
 160×1.0×1.2, 弯, 双头, 椭圆头
- Z0329R**
 160×1.5×1.8, 弯, 双头, 椭圆头



耳刮匙 (耳用环状刮匙)
Ear loop

	内径 Inner dia.	外径 Outer dia.
★ Z0226R 150×1直	φ1	φ2
★ Z0228R 150×2直	φ2	φ3
★ Z0230R 150×3直	φ3	φ4

	内径 Inner dia.	外径 Outer dia.
★ Z0227R 150×1弯	φ1	φ2

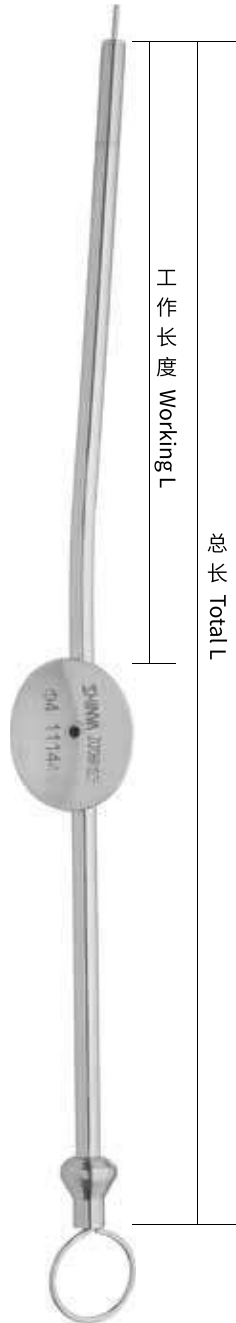

吸引管 (乳突吸引管)
Mastoid suction tube

	总长 Total L	工作长度 Working L
★ Z0135R 190×φ3	190	87
★ Z0136R 190×φ4	190	87
★ Z0137R 190×φ5	190	87



吸引管 (耳用)
Ear suction tube

	总长 Total L	工作长度 Working L
★ Z0262RN 50×φ1.5, 直	125	50
★ Z0263RN 50×φ2, 直	125	50



吸引管 (耳用)
Ear suction tube

	总长 Total L	工作长度 Working L
★ Z0266RN 90×φ1.5, 上弯	165	90
★ Z0267RN 90×φ2, 上弯	165	90

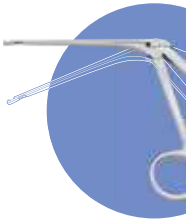

耳鼻喉科
Ear, Nose and Throat Instruments

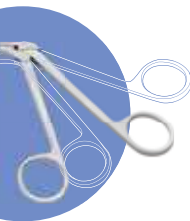

耳鼻咽喉科
 Ear, Nose and Throat Instruments

吸引管(耳用)
 Ear suction tube

	总长 Total L	工作长度 Working L
★Z0264RN 90×Φ1.5, 直	165	90
★Z0265RN 90×Φ2, 直	165	90

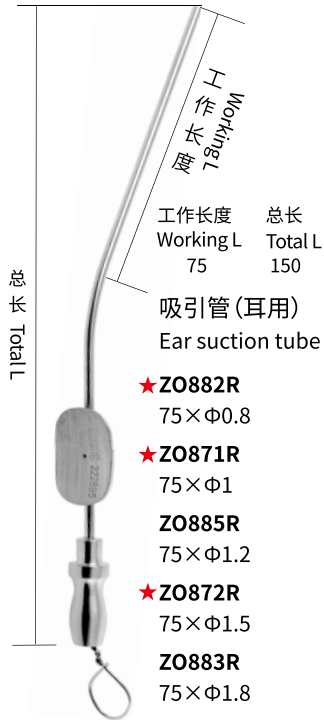

工作长度 Working L	总长 Total L
75	150

吸引管(耳用)
 Ear suction tube

- ★Z0882R
75×Φ0.8
- ★Z0871R
75×Φ1
- Z0885R
75×Φ1.2
- ★Z0872R
75×Φ1.5
- Z0883R
75×Φ1.8
- Z0873R
75×Φ2
- Z0884R
75×Φ2.5

吸引管(耳用)
 Ear suction tube

	总长 Total L	工作长度 Working L
★Z0268RN 90×Φ1.5, 下弯	165	90
★Z0269RN 90×Φ2, 下弯	165	90

显微剥离器(耳剥离器)
 Ear raspatory

- ★Z0183R 160×1
- ★Z0164R 160×1.5
- ★Z0165R 160×2

耳道皮瓣刀(耳横切口刀)
 Ear Knife

显微剥离器(耳开窗匙)
 Ear Raspatory

- ★Z0188R 160×0.9 右弯
Right curved
- ★Z0189R 160×0.9 左弯
Left curved

★Z0187R
160×2.4 锐 Sharp

Z0134R
160x2.5x90°, 角弯, 锐
Sharp



- ★ **ZO220R**
150×2, 平头
- ★ **ZO221R**
150×3, 平头
- ★ **ZO222R**
150×4, 平头

- ★ **ZO223R**
150×2, 圆头
- ★ **ZO224R**
150×3, 圆头
- ★ **ZO225R**
150×4, 圆头

乳突骨凿
Mastoid chisel



- ★ **ZO190R**
160×1.7, 直, 圆刃 Straight
- ★ **ZO138R**
160×2, 直, 圆刃 Straight

- ZO191R**
160×2 弯 Curved

耳用骨凿 (耳圆凿)
Ear gouge



耳用骨凿 (耳圆凿)
Ear gouge

- ★ **ZO139R**
130×3, 直, 圆刃 Straight

- ★ **ZO192R** 160×0.6
- ★ **ZO252R** 160×1.4, 直

耳用骨凿 (耳平凿)
Ear chisel

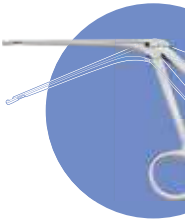

耳鼻喉科
Ear, Nose and Throat Instruments

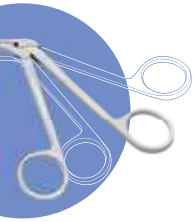

耳鼻咽喉科
 Ear, Nose and Throat Instruments



显微耳针 (蹬骨底板钻)
 Ear needle

- ★Z0193R 160×1
- ★Z0128R 160×0.5



耳道皮瓣刀 (耳切口刀)
 Ear knife

- ★Z0195R 160×2.2 直
 Straight



★Z0196R
 160×1.2 直 Straight

★Z0197R
 160×1.2 弯 Curved



Z0248R
 160, 半月形
 Half moon
 shaped

显微刀
 Ear knife



显微刀
 Ear knife, sickled-shape



耳钩
 Ear hook

- 
- ★ZO246R
 160×2.5×90°,锐 Sharp
 - ★ZO205R
 160×2×90°,钝 Blunt
 - ★ZO206R
 160×2×90°,锐 Sharp
 - ★ZO125R
 160×0.3×90°,锐 Sharp
 - ★ZO126R
 160×0.6×90°,锐 Sharp
 - ★ZO127R
 160×1×90°,锐 Sharp

- 
- ★ZO207R
 160×1.5×120°,锐 Sharp
 - ★ZO247R
 160×2×120°,锐 Sharp
 - ★ZO208R
 160×1.5×95°,锐 Sharp
 - ★ZO209R
 160×2.5×95°,锐 Sharp

耵聍钩
 Cerumen hook

- ★ZO133R
 160, 0.4×1.5/0.4×2
 双头, 枪形, 钝头
 Double ended, blunt

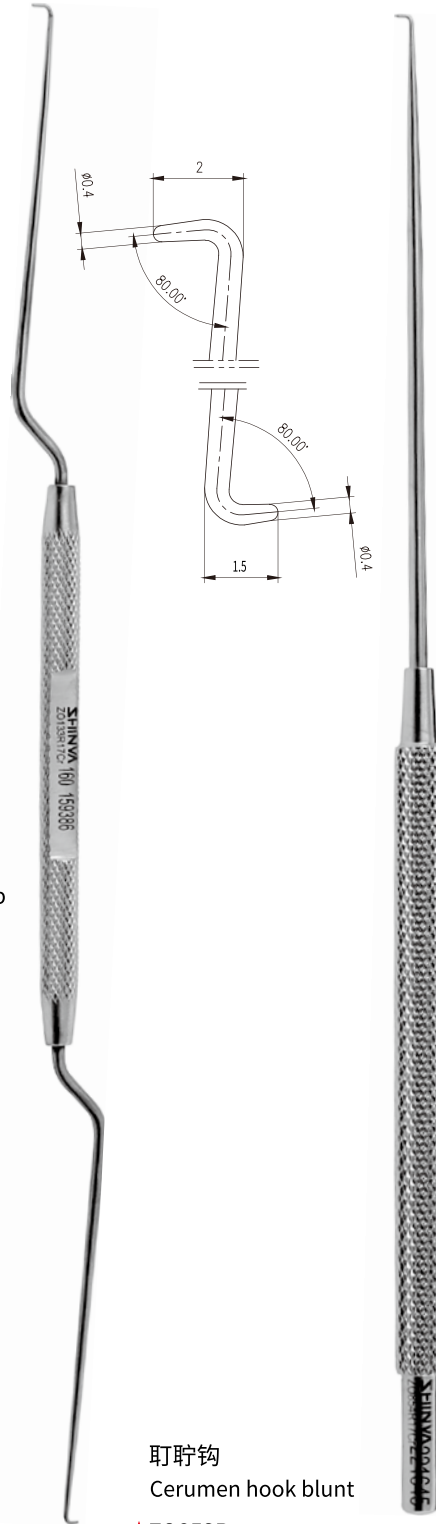

耵聍钩
 Cerumen hook blunt

- ★ZO853R
 h
 160×1.5, 单头, 角弯90°, 直形, 钝头
- ★ZO854R
 h
 160×2.0, 单头, 角弯90°, 直形, 钝头
- ★ZO855R
 h
 160×2.5, 单头, 角弯90°, 直形, 钝头

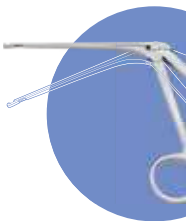
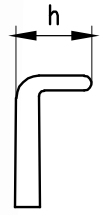

耳鼻喉科
 Ear, Nose and Throat Instruments

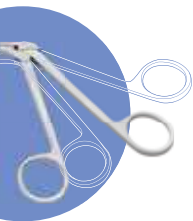

耳鼻咽喉科
 Ear, Nose and Throat Instruments



盯聆钩
 Cerumen hook blunt

- ★ **ZO856R**
 h
 200×1.5, 单头, 角弯90°, 枪形, 钝头
- ★ **ZO857R**
 h
 200×2.0, 单头, 角弯90°, 枪形, 钝头
- ZO858R**
 h
 200×2.5, 单头, 角弯90°, 枪形, 钝头

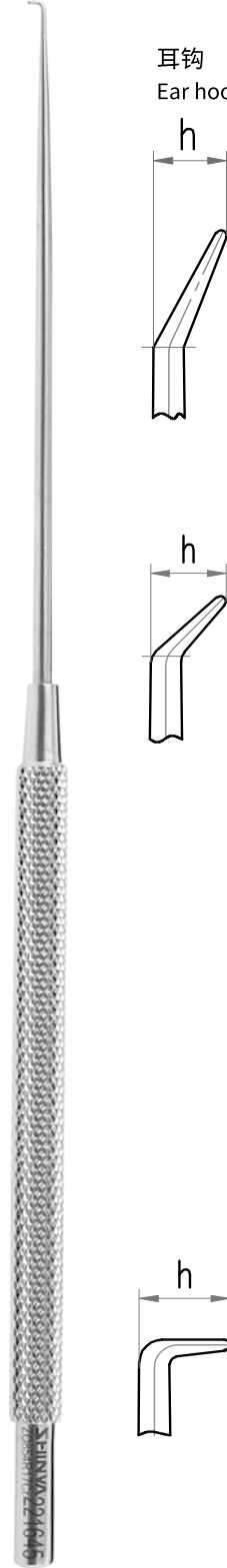

耳钩
 Ear hook, sharp

- ZO841R** 160×0.3×25°, 锐钩
- ZO842R** 160×0.6×25°, 锐钩
- ZO843R** 160×1×25°, 锐钩

- ZO844R** 160×0.3×45°, 锐钩
- ZO845R** 160×0.6×45°, 锐钩
- ZO846R** 160×1×45°, 锐钩

- ZO847R** 160×1.2×45°, 锐钩
- ZO848R** 160×1.5×45°, 锐钩
- ZO849R** 160×2×45°, 锐钩

- ZO850R** 160×1.2×90°, 锐钩
- ZO851R** 160×1.5×90°, 锐钩
- ZO852R** 160×2.5×90°, 锐钩



显微耳针 (蹬骨针)
Ear needle

★Z0123R 160 直、锐
Straight, sharp



显微耳针 (耳针)
Ear needle

★Z0124R 160×45°

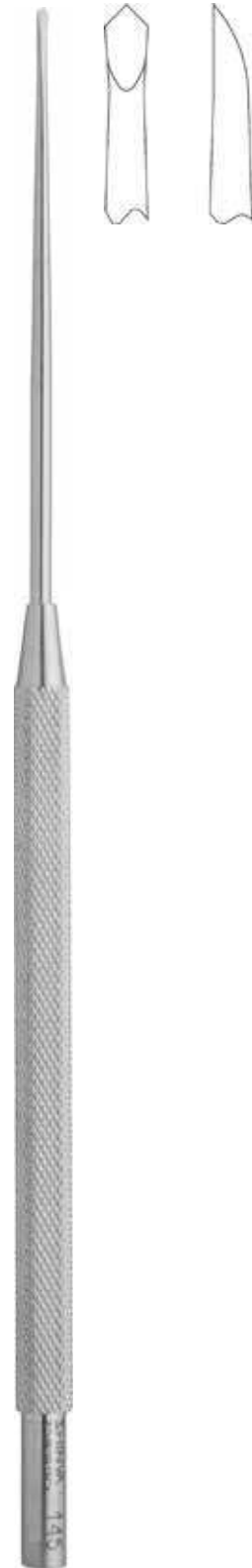

骨撬 (直撬、耳鼻喉用)
Lever

★Z0150R 145

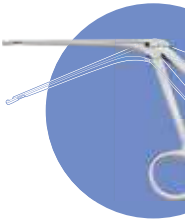

耳鼻喉科
Ear, Nose and Throat Instruments

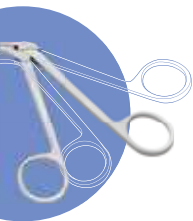

耳鼻咽喉科
 Ear, Nose and Throat Instruments

吸引管 (耳用)
 Ear suction tube

- ★Z0874R 90×Φ0.6
- ★Z0875R 90×Φ0.8
- ★Z0876R 90×Φ1
- ★Z0877R 90×Φ1.2
- ★Z0878R 90×Φ1.5
- ★Z0879R 90×Φ2
- ★Z0880R 90×Φ2.5
- ★Z0881R 90×Φ3

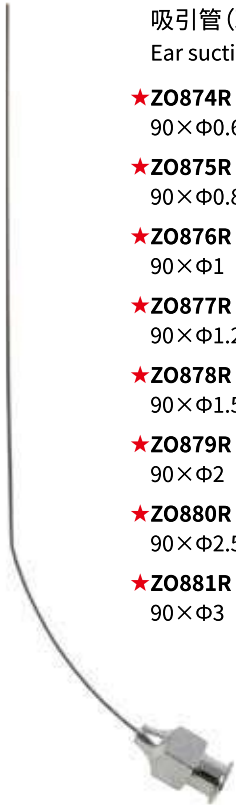

吸引头 (微型)
 Micro suction tip

- ★Z0149R 50
- 可与上图吸引管配合使用
 For the above suction tubes



Z0210R
 160×2.5 直 Straight

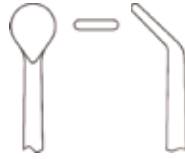

Z0211R
 160×2×45°角弯 Angled

Z0176R
 160×2.5×45°角弯 Angled



耳道皮瓣刀
 Ear knife

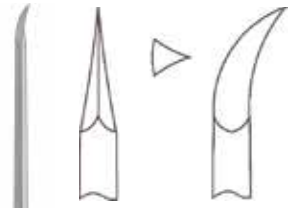

耳道皮瓣刀 (小镰状刀)
 Ear knife

- ★Z0182R 160





乳突牵开器(自动)
Self-retaining retractor

- ★**ZO132R** 130, 3×3钩, 钝钩, 固定式 Blunt
- ZO4005R** 130, 3×3钩, 锐钩, 固定式 Sharp



乳突牵开器(自动)
Self-retaining retractor

- ZO4003R** 130, 2×2钩, 钝钩, 固定式 Blunt
- ZO4004R** 130, 2×2钩, 锐钩, 固定式 Sharp



耳异物钳
Ear Foreign Body Forceps

- ★**ZO118R** 160×2×6, 麦粒头
- ★**ZO119R** 160×3×7, 麦粒头

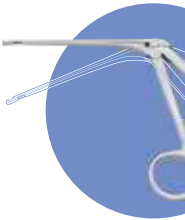

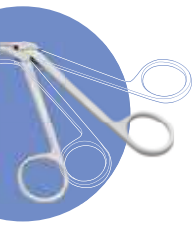

耳鼻咽喉科
Ear, Nose and Throat Instruments



耳用探针
Ear probe

★Z0113R
180, 枪状



耵聍钩
Cerumen hook

★Z0129R
200×2
★Z0130R
200×4



耳用膝状镊
Troeltsch ear dressing forceps

★Z0114MB
110
★ZD860R
170

组织钳(筋膜钳)
Anadesma forceps

Z0356RN 190





筋膜压薄器(人工鼓环)
Anadesma thinning device

ZO3886RN
螺旋式, 60×40
Screw type



鼻组织剪
Nasal dissecting scissors

- ★ **ZO555RN** 120, 直, 管式 Straight
- ★ **ZO556RN** 120, 左弯, 管式 Left curved
- ★ **ZO557RN** 120, 右弯, 管式 Right curved



鼻组织剪
Nasal dissecting scissors

- ★ **ZO544RN** 130, 盖板式, 直 Straight
- ★ **ZO367RN** 130, 盖板枪式, 左 Left curved
- ★ **ZO368RN** 130, 盖板枪式, 右 Right curved

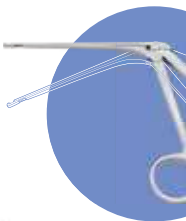

耳鼻喉科
Ear, Nose and Throat Instruments

鼻剪
Nasal dissecting scissors

★Z0112RN 160, 上介



鼻剪
Nasal dissecting scissors

★Z0536RN 110, 枪式, 下介



鼻剪
Nasal dissecting scissors

★Z0541RN 125, 中介

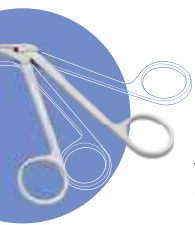

耳鼻咽喉科
Ear, Nose and Throat Instruments

鼻咬切钳(鼻咬骨钳)
 Nasal cutting forceps

★Z0562RN

120×3.5, 盖板式, 下弯, 反切
 Downward curved



鼻咬切钳(鼻咬骨钳)
 Nasal cutting forceps



★Z0558RN 120×1.5, 盖板式, 正切
 Straight



★Z0560RN 120×2, 盖板式, 左反切
 Left cutting



★Z0559RN 120×2, 盖板式, 反切



★Z0561RN 120×2, 盖板式, 右反切
 Right cutting

★Z0639RN 150×2, 盖板式, 反切



鼻咬切钳
 Nasal cutting forceps



★Z0587RN 120×2, 直, 长圆头 Straight

★Z0588RN 120×3, 直, 长圆头 Straight

Z03605RN 160×3, 直, 长圆头 Straight



★Z0589RN 120×2×30°, 角弯, 长圆头 Angled

★Z0590RN 120×3×30°, 角弯, 长圆头 Angled

Z03606RN 160×3×30°, 角弯, 长圆头 Angled

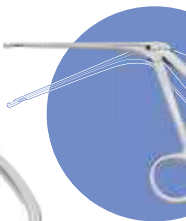

耳鼻喉科
 Ear, Nose and Throat Instruments

鼻咬切钳
 Nasal cutting forceps



★ **ZO3396RN**
 120×3, 盖板式, 角弯45°, 长圆头

★ **ZO3395RN**
 120×2, 盖板式, 角弯45°, 长圆头

ZO3602RN
 160×2×45°, 盖板式, 角弯45°, 长圆头

ZO3604RN
 160×3×45°, 盖板式, 角弯45°, 长圆头

ZO3621RN
 180×2×45°, 盖板式, 角弯45°, 长圆头

ZO3623RN
 180×3×45°, 盖板式, 角弯45°, 长圆头

ZO3392RN
 120×1, 盖板式, 直, 长圆头

★ **ZO3393RN**
 120×2, 盖板式, 直, 长圆头

★ **ZO3394RN**
 120×3, 盖板式, 直, 长圆头

ZO3601RN
 160×2, 盖板式, 直型, 长圆头

ZO3603RN
 160×3, 盖板式, 直型, 长圆头

ZO3620RN
 180×2, 盖板式, 直型, 长圆头

ZO3622RN
 180×3, 盖板式, 直型, 长圆头



★ **ZO334RN**
 150×2, 盖板式, 尖头, 直

★ **ZO335RN**
 150×2.5, 盖板式, 尖头, 直



★ **ZO336RN**
 150×2, 盖板式, 尖头, 上翘45°

★ **ZO337RN**
 150×2.5, 盖板式, 尖头, 上翘45°

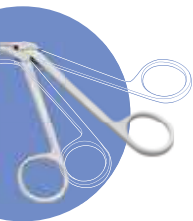

耳鼻咽喉科
 Ear, Nose and Throat Instruments



鼻咬切钳
Nasal cutting forceps

- ★ **ZO343RN** 100×2反切带, 吸引长圆头
- ★ **ZO391RN** 100×3反切带, 吸引长圆头



鼻咬切钳
Nasal cutting forceps rotatable

- ★ **ZO389RN** 110×1.5管式反切可旋转长圆头
- ★ **ZO390RN** 110×2.5管式反切可旋转长圆头

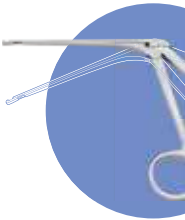

上颌窦咬骨钳
 Nasal cutting forceps

★ **ZO306RN** 150×3.2, 上切

★ **ZO311RN** 150×4, 上切
 Upward cutting

ZO313RN 150×3, 上切45°

ZO315RN 150×5, 上切45°
 Upward 45 cutting

ZO307RN 150×3.2, 下切

ZO312RN 150×4, 下切
 Downward cutting

ZO314RN 150×3, 下切45°

ZO316RN 150×5, 下切45°
 Downward 45 cutting

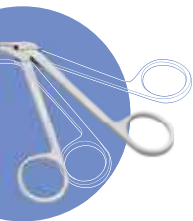
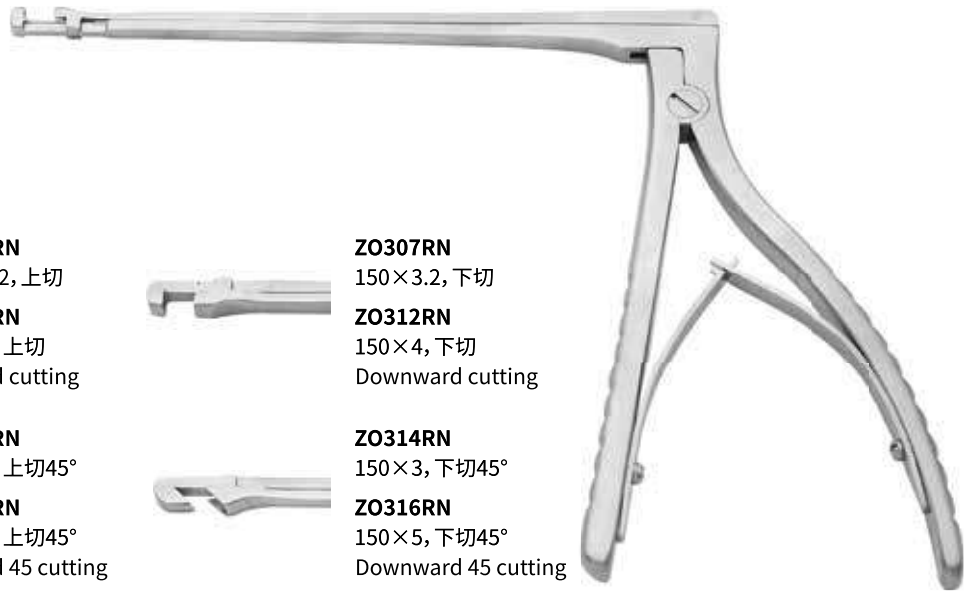

耳鼻喉科
 Ear, Nose and Throat Instruments

蝶窦咬骨钳(鼻窦咬骨钳)
 Nasal cutting forceps

★ **ZO495RN** 150×120°×2, 上切口

★ **ZO496RN** 150×120°×3, 上切口

★ **ZO430R** 180×135°×2

★ **ZO431R** 180×135°×2.5

★ **ZO432R** 180×135°×3

ZO4001RN 150×90°×2, 上切口

ZO4002RN 150×90°×3, 上切口

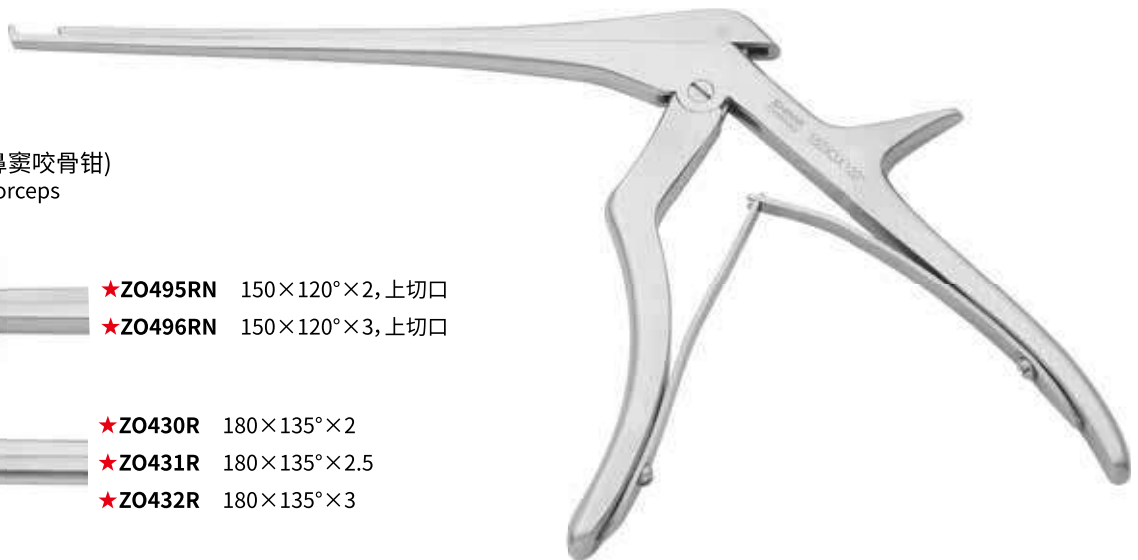

蝶窦咬骨钳(鼻窦咬骨钳)
Nasal cutting forceps

- ★ **ZO497RN**
140×2.5×90°, 可旋转
Rotatable



鼻中隔咬骨钳
Septum cutting forceps

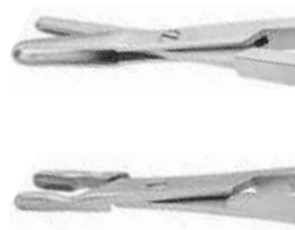

- ★ **ZO423RN** 180×2, 对切口
- ★ **ZO425RN** 180×3, 对切口
- ★ **ZO426RN** 180×4, 对切口
- ★ **ZO424RN** 180×3, 对咬口
- ★ **ZO427RN** 180×4, 对咬口

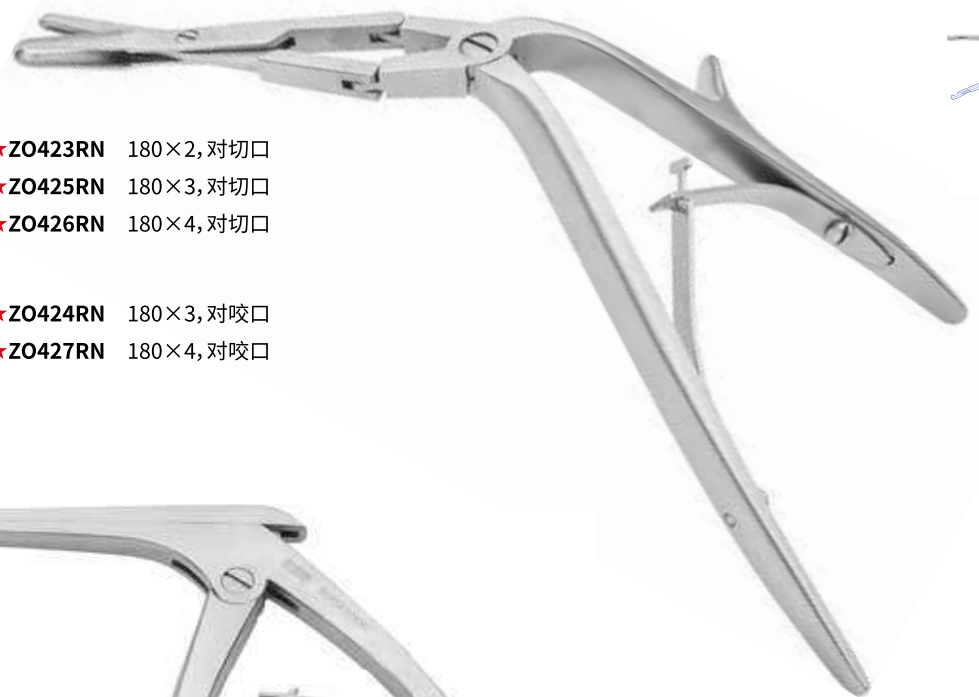

乳突咬骨钳
Mastoid cutting forceps

- ZO340RN** 90×2
- ★ **ZF647RN** 90×3
- ★ **ZF648RN** 90×4
- ZF649RN** 90×5

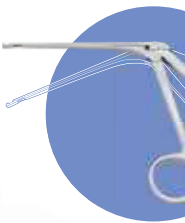

耳鼻喉科
Ear, Nose and Throat Instruments

鼻组织钳
Nasal tissue forceps



★**Z03568RN**
130×4.5, 直, 管式, 尖圆头
Straight



★**Z03569RN**
130×4×55°, 左弯, 管式, 尖圆头



Z03570RN
130×4.5×55°, 左弯, 管式, 尖圆头
Left curved



Z03571RN
130×4×55°, 右弯, 管式, 尖圆头



Z03572RN
130×4.5×55°, 右弯, 管式, 尖圆头
Right curved

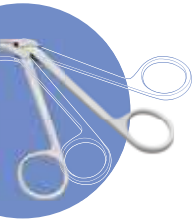

耳鼻咽喉科
Ear, Nose and Throat Instruments

鼻组织钳
Nasal tissue forceps

Z0506RN 120×5, 盖板式, 直圆头

Z0507RN 120×6, 盖板式, 直圆头

Z0508RN 120×7, 盖板式, 直圆头



鼻组织钳
Nasal tissue forceps

★**Z0563RN**
120×4, 盖板式, 直带齿长圆头





鼻组织钳
 Nasal tissue forceps

★ZO573RN 120×5×110°, 横开, 管式, 蝴蝶头



鼻组织钳(鼻息肉钳)
 Nasal polypus forceps

★ZO638RN 150×3, 直尖圆, 带孔

★ZO3500RN 120×3, 直尖圆, 带孔

★ZO3498RN 120×3, 直长圆头
 ZO3633RN 160×3, 直长圆

★ZO3501RN 120×4, 直尖圆, 带孔
 ZO3630RN 160×3, 直尖圆, 带孔

★ZO3509RN
 120×5, 盖板式, 直椭圆头

★ZO3502RN 120×3, 角弯45°, 尖圆头, 带孔
 ★ZO3503RN 120×4, 角弯45°, 尖圆头, 带孔
 ZO3632RN 160×3, 角弯45°, 尖圆头, 带孔

★ZO3499RN 120×3, 角弯45°, 长圆头
 ZO3634RN 160×3, 角弯30°, 长圆头
 ZO3635RN 160×3, 角弯45°, 长圆头

★ZO3504RN 120×3, 角弯90°, 尖圆头, 带孔
 ★ZO3505RN 120×4, 角弯90°, 尖圆头, 带孔
 ZO615RN 110×4×90°, 尖圆头, 带孔

★ZO3576RN 120×3, 角弯30°, 尖圆头, 带孔
 ZO3631RN 160×3, 角弯30°, 尖圆头, 带孔

ZO574RN 120×4, 直长圆头

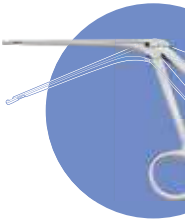

耳鼻喉科
 Ear, Nose and Throat Instruments



鼻组织钳(鼻息肉钳)

Nasal polypus forceps with suction

- ★ZO564R 120×4, 盖板式带吸引, 直尖圆头 Straight
- ZO565R 120×4×30°, 盖板式带吸引, 角弯尖圆头 Angled
- ZO566R 120×4×45°, 盖板式带吸引, 角弯尖圆头 Angled
- ZO567R 120×4×90°, 盖板式带吸引, 角弯尖圆头 Angled

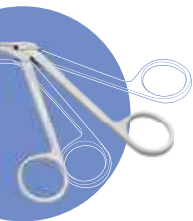

耳鼻喉科
 Ear, Nose and Throat Instruments



鼻咽活体取样钳(鼻取样钳)

Nasal biopsy forceps

- ★ZO514RN 140, 直, 管式, 长圆头, 竖开
 Straight, vertical opening
- ★ZO515RN 140, 直, 管式, 长圆头, 横开
 Straight, horizontal opening
- ★ZO516RN 140×70°, 管式
 角弯, 长圆头, 竖开
 Angled, vertical opening
- ★ZO517RN 140×70°, 管式
 角弯, 长圆头, 横开
 Angled, horizontal opening
- ★ZO518RN 140×110°, 管式
 角弯, 长圆头, 竖开
 Angled, vertical opening
- ★ZO519RN 140×100°, 管式
 角弯, 长圆头, 横开
 Angled, horizontal opening



鼻咽活体取样钳(鼻取样钳)
Nasal biopsy forceps straight

- ★Z0510RN 160×3, 盖板式, 直形
- ★Z0512RN 160×4, 盖板式, 直形



鼻咽活体取样钳(鼻取样钳)
Nasal biopsy forceps angled

- ★Z0511RN 140×3, 盖板式, 角弯
- Z0513RN 140×4, 盖板式, 角弯



鼻咽活体取样钳(鼻取样钳)
Nasal biopsy forceps angled

- ★Z0579RN 140×3, 盖板式, 角弯, 长圆头

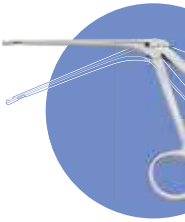



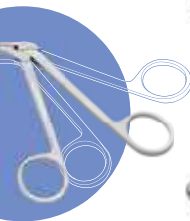

耳鼻喉科
Ear, Nose and Throat Instruments

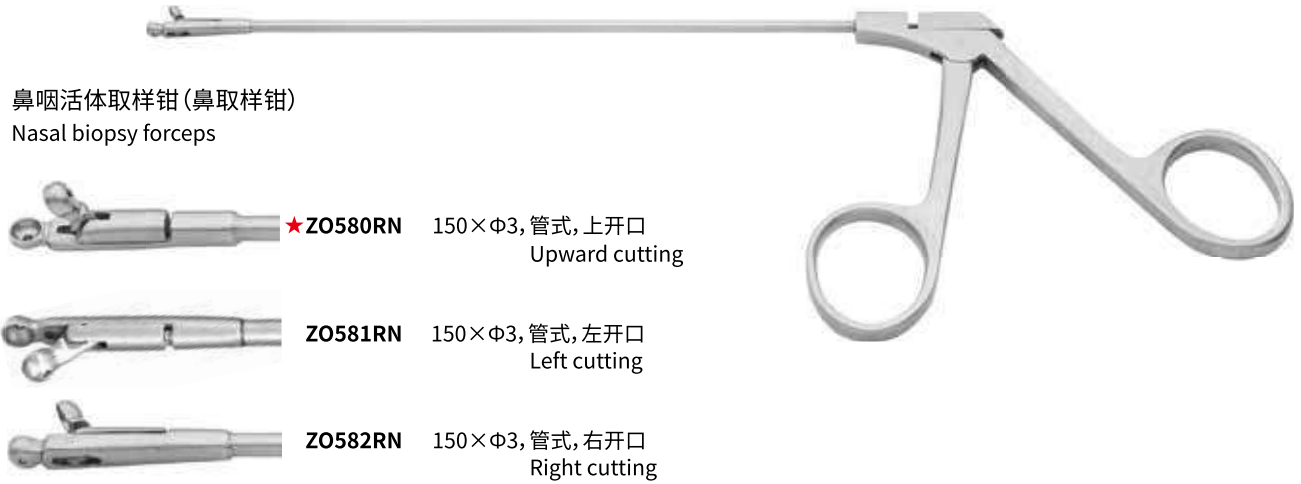

耳鼻咽喉科
 Ear, Nose and Throat Instruments





鼻咽活体取样钳(鼻取样钳)
 Nasal biopsy forceps



-  **★Z0580RN** 150×Φ3, 管式, 上开口
Upward cutting
-  **Z0581RN** 150×Φ3, 管式, 左开口
Left cutting
-  **Z0582RN** 150×Φ3, 管式, 右开口
Right cutting



鼻咽活体取样钳(鼻取样钳)
 Nasal biopsy forceps with suction



-  **Z0584RN** 170×3×30°, 角弯, 管式带吸引
-  **Z0585RN** 170×3×45°, 角弯, 管式带吸引
Angled
-  **Z0583RN** 170×3, 直, 管式带吸引
Straight
-  **Z0586RN** 170×3×90°, 角弯, 管式带吸引
Angled

鼻异物钳
 Nasal foreign body forceps



-  **★Z0453RN** 110, 有钩, 盖板式
With mouseteeth
-  **★Z0454RN** 110, 无钩, 盖板式

鼻筛窦钳(鼻筛窦开放钳)
Antrum forceps



★ZO1024RN 130×4, 直, 长圆头



★ZO1026RN 130×4.5, 直, 尖圆头



★ZO1027RN 130×5.5, 直, 尖圆头

★ZO1025RN 130×4×45°, 角弯, 长圆头



鼻粘膜钳
Nasal forceps

★ZO1036RN 120×5

ZO1037RN 120×6



上颌窦止血钳
Hemostatic forceps

ZO308RN 125×3.5

ZO309RN 125×4

ZO310RN 125×4.5

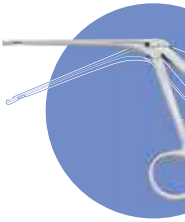

耳鼻喉科
Ear, Nose and Throat Instruments



鼻息肉钳 (吸引息肉钳)
 Polypus forceps, detachable straight

- ★Z01043RN 140×Φ3, 直, 可拆卸
- ★Z01044RN 140×Φ4, 直, 可拆卸
- ★Z01045RN 140×Φ5, 直, 可拆卸

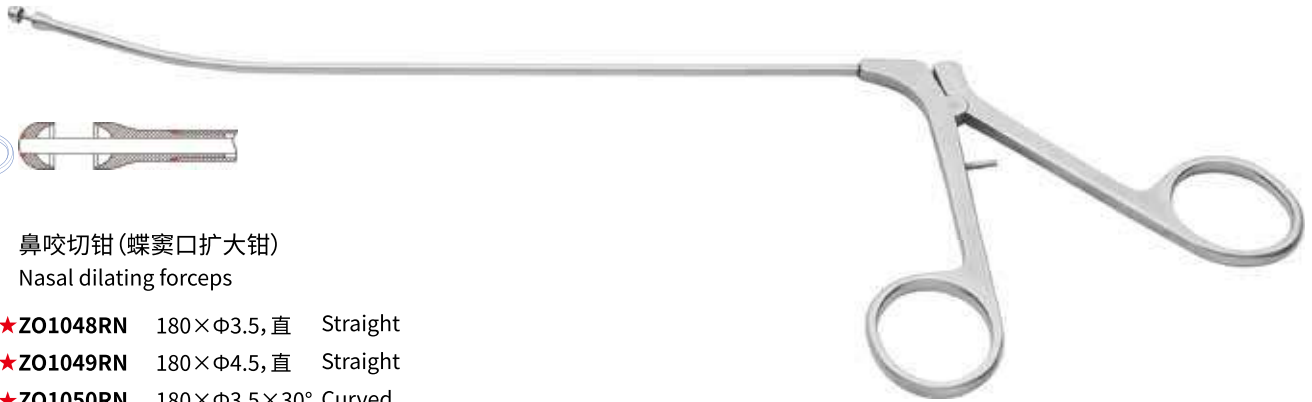

鼻咬切钳 (蝶窦口扩大钳)
 Nasal dilating forceps

- ★Z01048RN 180×Φ3.5, 直 Straight
- ★Z01049RN 180×Φ4.5, 直 Straight
- ★Z01050RN 180×Φ3.5×30° Curved
- ★Z01051RN 180×Φ4.5×30° Curved



鼻组织钳 (鼻窦抓钳)
 Antrum grasping forceps

- ★Z01065RN 135×5, 下弯90°, 后开120°
 Downward curved 90, backward 120
- ★Z01067RN 140×5, 长弯下弯115°
 Downward 115

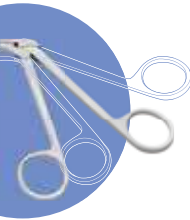

耳鼻喉科
 Ear, Nose and Throat Instruments

鼻组织钳(鼻窦抓钳)
Antrum grasping forceps



鼻息肉钳
Nasal polypus forceps

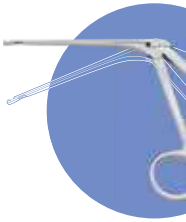
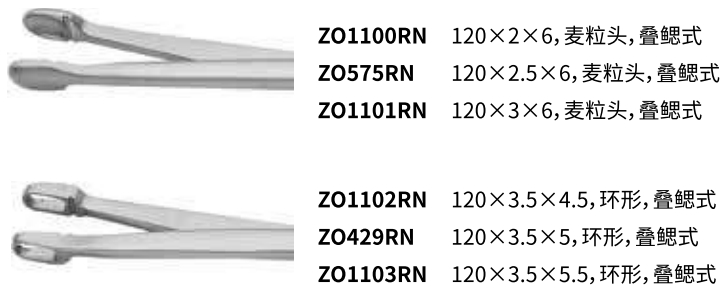

耳鼻喉科
Ear, Nose and Throat Instruments

鼻息肉钳
Nasal polypus forceps

- ZO1110RN** 110×2×4, 麦粒头, 叠鳃式
- ZO1111RN** 110×2.5×4, 麦粒头, 叠鳃式
- ZO1112RN** 110×3×4, 麦粒头, 叠鳃式



鼻腔填塞钳
Nasal dressing forceps

- ★ **ZO481RN** 180

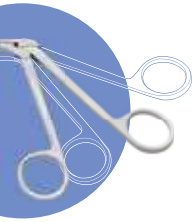

耳鼻喉科
Ear, Nose and Throat Instruments



鼻腔撑开器(鼻中隔镜)
Nasal septum speculum

★ZO383R
55×80, 鼻腔撑开器(鼻中隔镜)



鼻刮匙(鼻窦刮匙)
Antrum curette



ZO1004RN
190×4, 直, 碗形有孔



ZO1009RN
190×4.5, 直, 碗形有孔



ZO1014RN
190×5, 直, 碗形有孔



ZO1005RN
190×4×15°, 弯, 碗形有孔



ZO1010RN
190×4.5×15°, 弯, 碗形有孔

ZO1015RN
190×5×15°, 弯, 碗形有孔

ZO1006RN
190×4×30°, 弯, 碗形有孔

ZO1011RN
190×4.5×30°, 弯, 碗形有孔

ZO1016RN
190×5×30°, 弯, 碗形有孔

ZO1007RN
190×4×45°, 弯, 碗形有孔

ZO1012RN
190×4.5×45°, 弯, 碗形有孔

ZO1017RN
190×5×45°, 弯, 碗形有孔

ZO1008RN
190×4×90°, 弯, 碗形有孔

ZO1013RN
190×4.5×90°, 弯, 碗形有孔

ZO1018RN
190×5×90°, 弯, 碗形有孔



鼻刮匙
Nasal curette



★**ZO520RN**
190×90°×2.5
单头, 角弯, 匙形



★**ZO521RN**
190×45°×2.5
单头, 角弯, 匙形



★**ZO522RN**
190×3.5
单头, 角弯, 匙形



ZO523RN
190×4.5
单头, 角弯, 匙形

ZO524RN
190×Φ4.5
单头, 弯, 碗形

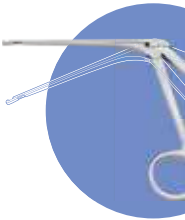

耳鼻喉科
Ear, Nose and Throat Instruments

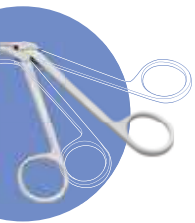

耳鼻咽喉科
 Ear, Nose and Throat Instruments



鼻刮匙
 Nasal curette

★Z0525RN
 190×5.5, 单头
 直, 匙形



鼻刮匙
 Nasal curette

★Z0526RN
 210, Φ6/Φ8
 双头, 弯环形



鼻刮匙
 Nasal curette

★Z0527RN
 190×Φ3
 单头, 弯环形



鼻刮匙
 Nasal curette



- Z0616R 170×5, 直型, 有孔, 圆刃
- Z0617R 170×5.6, 直型, 有孔, 圆刃
- Z0618R 170×7, 直型, 有孔, 圆刃
- Z0619R 170×5×15°, 有孔, 圆刃
- Z0483R 170×5.6×15°, 圆刃, 有孔
- Z0416R 170×7×15°, 圆刃, 有孔
- Z0620R 170×5×30°, 有孔, 圆刃
- Z0540R 170×5.6×30°, 圆刃, 有孔
- Z0538R 170×7×30°, 圆刃, 有孔
- Z0621R 170×5×45°, 有孔, 圆刃
- Z0622R 170×5.6×45°, 有孔, 圆刃
- Z0623R 170×7×45°, 有孔, 圆刃



★Z0543R 170×7×110°, 圆刃



Z0539R 170×5.6×30°, 三角刃

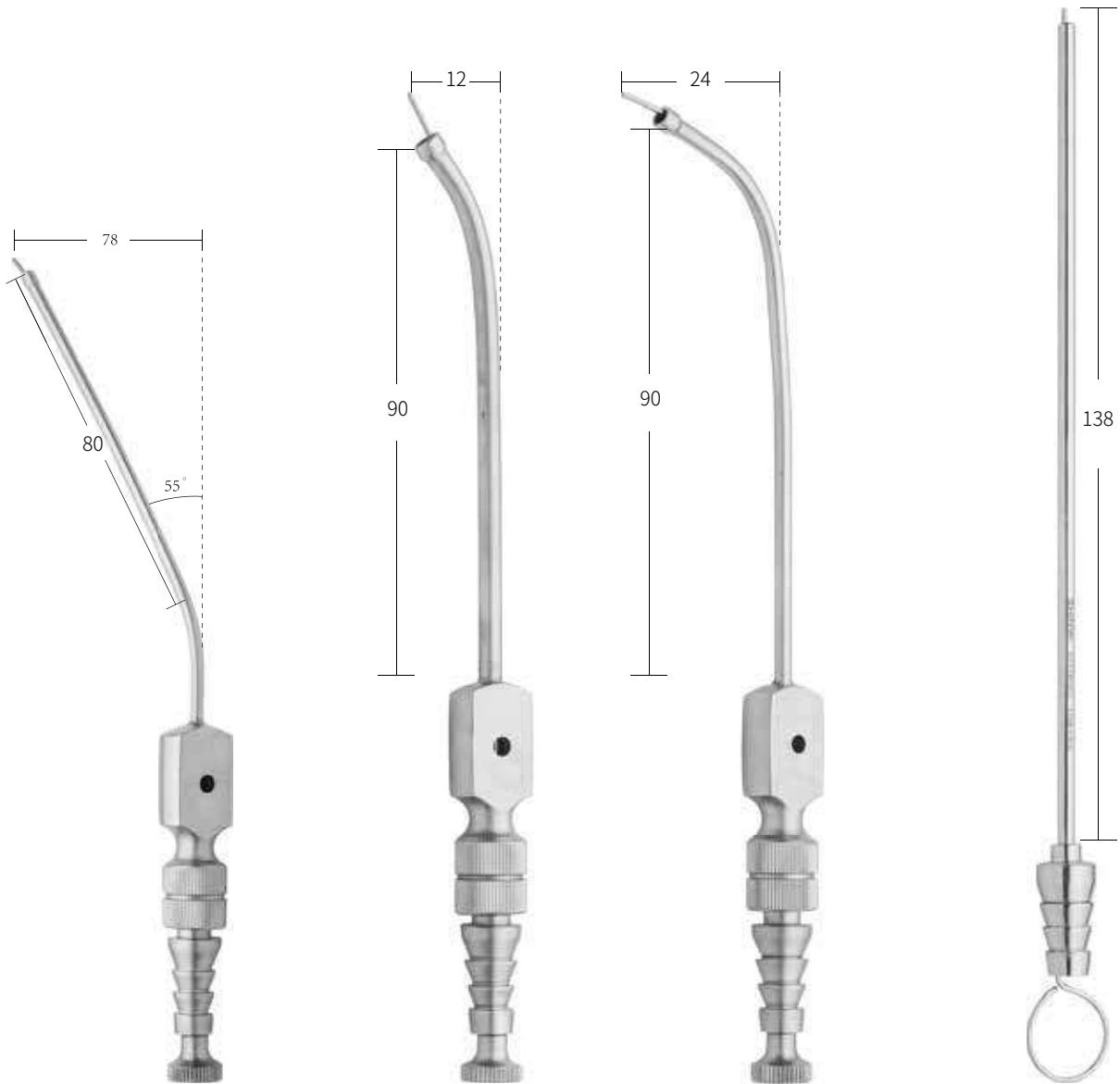

鼻腔吸引管
 Nasal suction tube

- ★ **ZO532RN**
 130×Φ2.5×55°×78
- ★ **ZO592RN**
 130×Φ3×55°×78
- ★ **ZO533RN**
 130×Φ4×55°×78

鼻腔吸引管
 Nasal suction tube

- ★ **ZO528RN**
 150×Φ2.5×12
- ★ **ZO529RN**
 150×Φ4×12

鼻腔吸引管
 Nasal suction tube

- ★ **ZO530RN**
 150×Φ2.5×24, 弯
- ★ **ZO591RN**
 150×Φ3×24, 弯
- ★ **ZO531RN**
 150×Φ4×24, 弯

鼻腔吸引管
 Nasal suction tube

- ★ **ZO730R**
 160×Φ2, 直
- ★ **ZO731R**
 160×Φ3, 直
- ★ **ZO732R**
 160×Φ4, 直

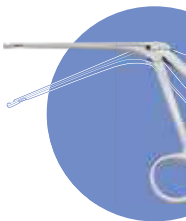

耳鼻喉科
 Ear, Nose and Throat Instruments

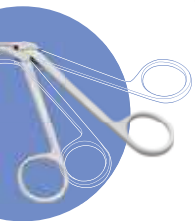

耳鼻喉科
 Ear, Nose and Throat Instruments

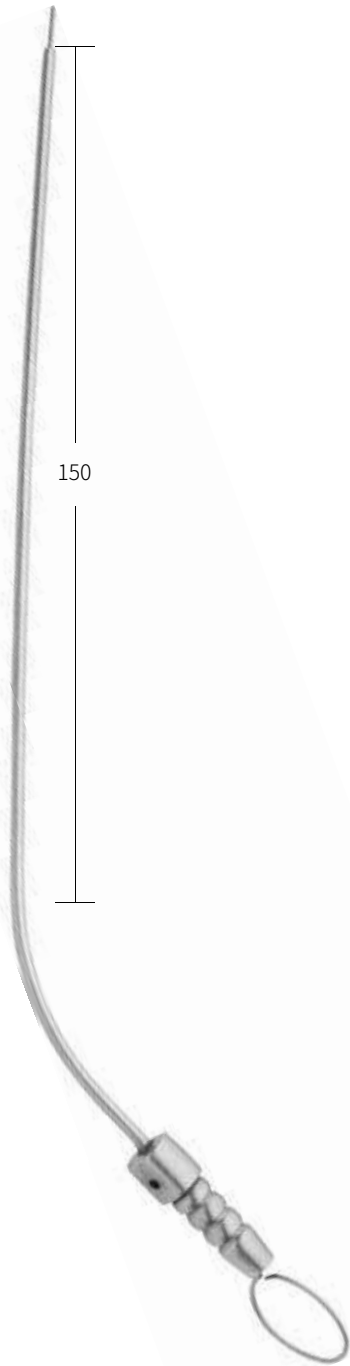

鼻腔吸引管
 Nasal suction tube

- ★Z01074RN 220×Φ2.5
- ★Z01075RN 220×Φ3
- ★Z01077RN 220×Φ4



鼻腔吸引管
 Nasal suction tube

- ★Z0733R 160×Φ2, 弯
- ★Z0734R 160×Φ3, 弯
- ★Z0735R 160×Φ4, 弯

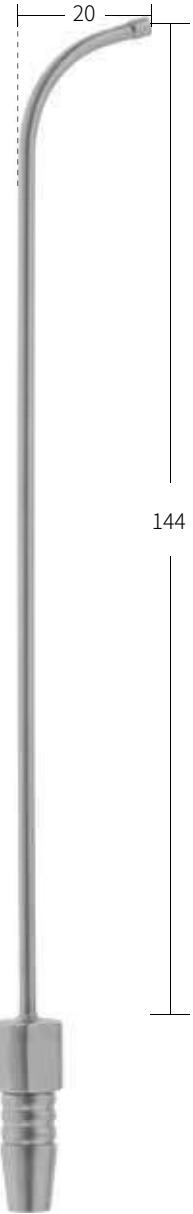

鼻腔吸引管
 Nasal suction tube

- ★Z01084RN 170×Φ2.5
- ★Z01085RN 170×Φ3
- ★Z01086RN 170×Φ3.5
- ★Z01087RN 170×Φ4



鼻腔吸引管
Nasal suction tube

- ★ **ZO1080RN**
180×Φ2.5×47, 弯
- ★ **ZO1081RN**
180×Φ3.5×47, 弯
- ★ **ZO1083RN**
180×Φ3×47, 弯



鼻腔吸引管
Nasal suction tube

- ★ **ZO1088RN** 190×Φ2.5
- ★ **ZO1089RN** 190×Φ3
- ★ **ZO1090RN** 190×Φ3.5
- ★ **ZO1091RN** 190×Φ4

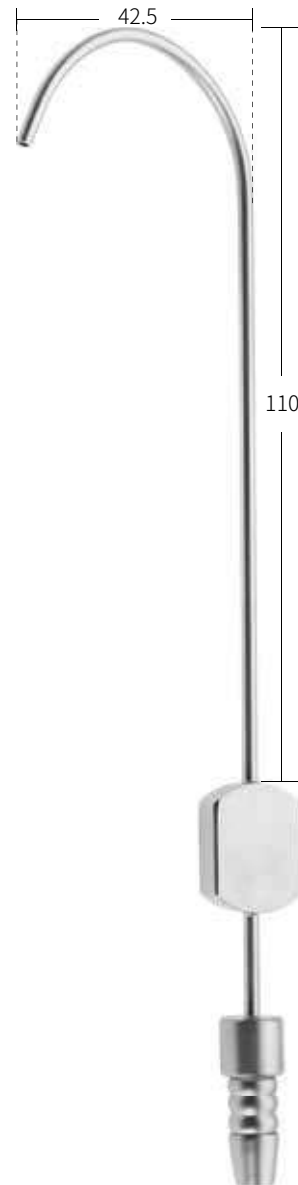

鼻腔吸引管
Nasal suction tube

- ★ **ZO1092RN**
175×Φ2.5, 钩状, 可控
- ★ **ZO1093RN**
175×Φ3, 钩状, 可控
- ★ **ZO1094RN**
175×Φ3.5, 钩状, 可控

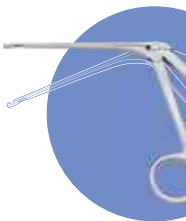

耳鼻喉科
Ear, Nose and Throat Instruments

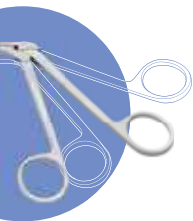

耳鼻喉科
Ear, Nose and Throat Instruments

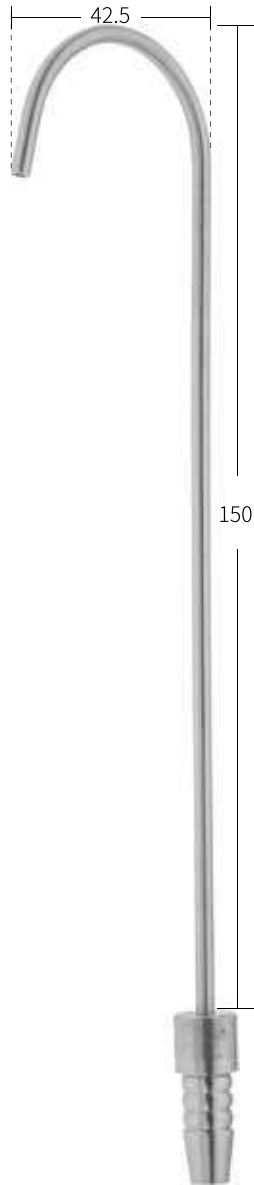

鼻腔吸引管
Nasal suction tube

- ★ **ZO1095RN**
175×Φ2.5, 钩状
- ★ **ZO1096RN**
175×Φ3, 钩状
- ★ **ZO1097RN**
175×Φ3.5, 钩状



鼻腔吸引管
Nasal suction tube

- ZO1273RN**
175×Φ2.5
- ZO1274RN**
175×Φ3
- ZO1275RN**
175×Φ3.5



鼻窦冲洗器(上颌窦灌洗管)
Antrum irrigation cannula

- ★ **ZO413R** Φ2×120
- ★ **ZO442R** Φ2.5×120
- ★ **ZO443R** Φ3×120

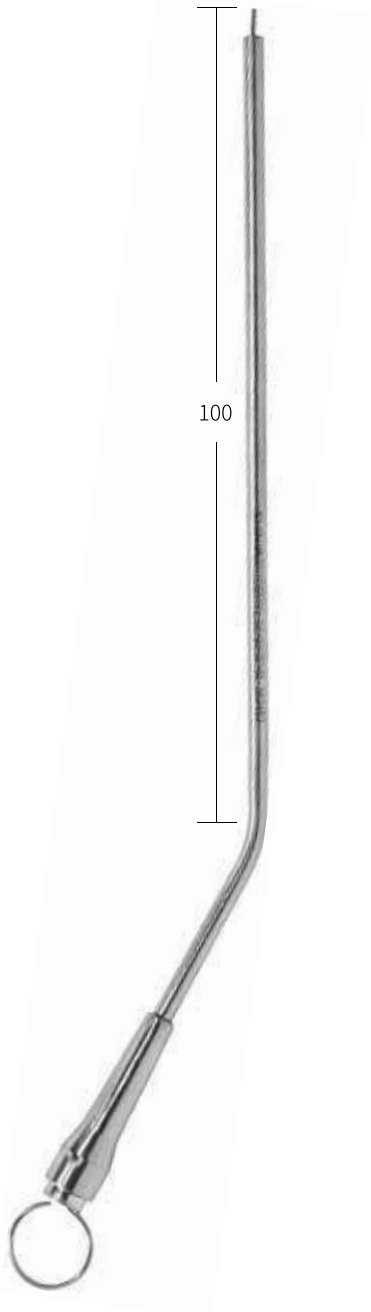

鼻腔吸引管
Nasal suction tube

- ZO1280RB**
155×Φ1.5×30°×55
- ZO1281RB**
155×Φ2×30°×55
- ZO1282RB**
155×Φ2.5×30°×55
- ZO1283RB**
155×Φ3×30°×55
- ZO1284RB**
155×Φ3.5×30°×55

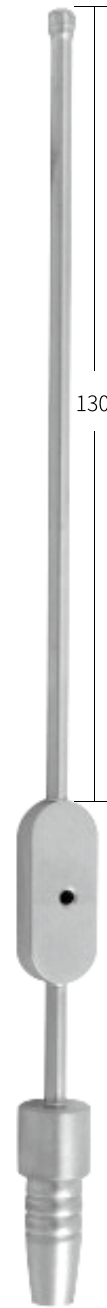

鼻腔吸引管
Nasal suction tube

- ZO1113RN**
190×Φ2.5, 直, 可控, 带保护套
- ZO1114RN**
190×Φ3, 直, 可控, 带保护套
- ZO1115RN**
190×Φ3.5, 直, 可控, 带保护套
- ZO1116RN**
190×Φ4, 直, 可控, 带保护套

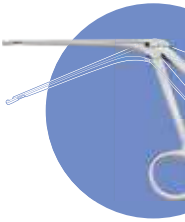

耳鼻喉科
Ear, Nose and Throat Instruments

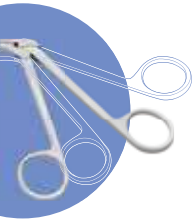

耳鼻喉科
Ear, Nose and Throat Instruments



鼻骨膜剥离器
Nasal periosteum raspator

- ★**ZO380RN**
200×4×5, 双头带刻度, 铲形
- ★**ZO465RN**
200×2×4, 双头带刻度, 铲形



鼻骨膜剥离器
Nasal periosteum raspator

- ★**ZO406RN**
180×3, 单头带吸引铲形
- ★**ZO402RN**
180×5, 单头带吸引铲形



剥离器
Elevator with suction

- ZO628RN**
2.5×45°, 带吸引
- ZO1020RN**
2.5×60°, 带吸引
- ZO1019RN**
2.5×90°, 带吸引



鼻骨膜剥离器
Nasal periosteum raspator

- ★**ZO411R** 160×5
- ★**ZO412R** 160×6
- ★**ZO414R** 170x4.2, 锐 Sharp



鼻骨膜剥离器
Nasal periosteum raspatory

★Z0410R 140微弯双刃



鼻骨膜剥离器
Nasal periosteum raspatory

★Z0403RN
200×4×5, 双头, 直长圆形
Straight



★Z0121R
190, 头宽4/4, 直
Straight, tip width 3*3



★Z0122R
190, 头宽3/3, 弯
Curved, tip width 3*3



★Z0546RN
180×5×5, 双头, 弯 Curved

★Z0462RN
200×5×5, 双头, 直长圆形
Curved



鼻骨膜剥离器
Nasal periosteum raspatory

★Z0466RN
190×1, 单头, 微弯, 长圆形

★Z0467RN
190×3, 单头, 微弯, 长圆形

★Z0593RN
190×4.5, 单头, 微弯, 长圆形
Slightly curved



★Z0468RN
190×3, 单头, 弯, 长圆形
Curved

★Z0469RN
190×4, 单头, 角弯, 长圆形
Angled

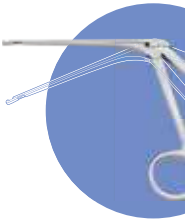

耳鼻喉科
Ear, Nose and Throat Instruments

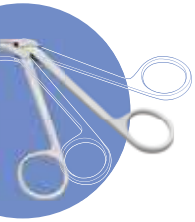

耳鼻咽喉科
Ear, Nose and Throat Instruments



鼻骨复位钳
Nasal reposition forceps
★ Z01032RN 200弯



鼻骨复位器
Nasal repositioner
★ Z01033R 220×4



鼻穿刺针
Nasal puncture needle



Z0381RN
170×Φ3, 平口



Z0596RN
170×Φ4, 平口



★ Z0597RN
170×Φ3, 斜口



★ Z0598RN
170×Φ4, 斜口



Z0599RN
170×Φ3, 鸟喙口



Z0600RN
170×Φ4, 鸟喙口

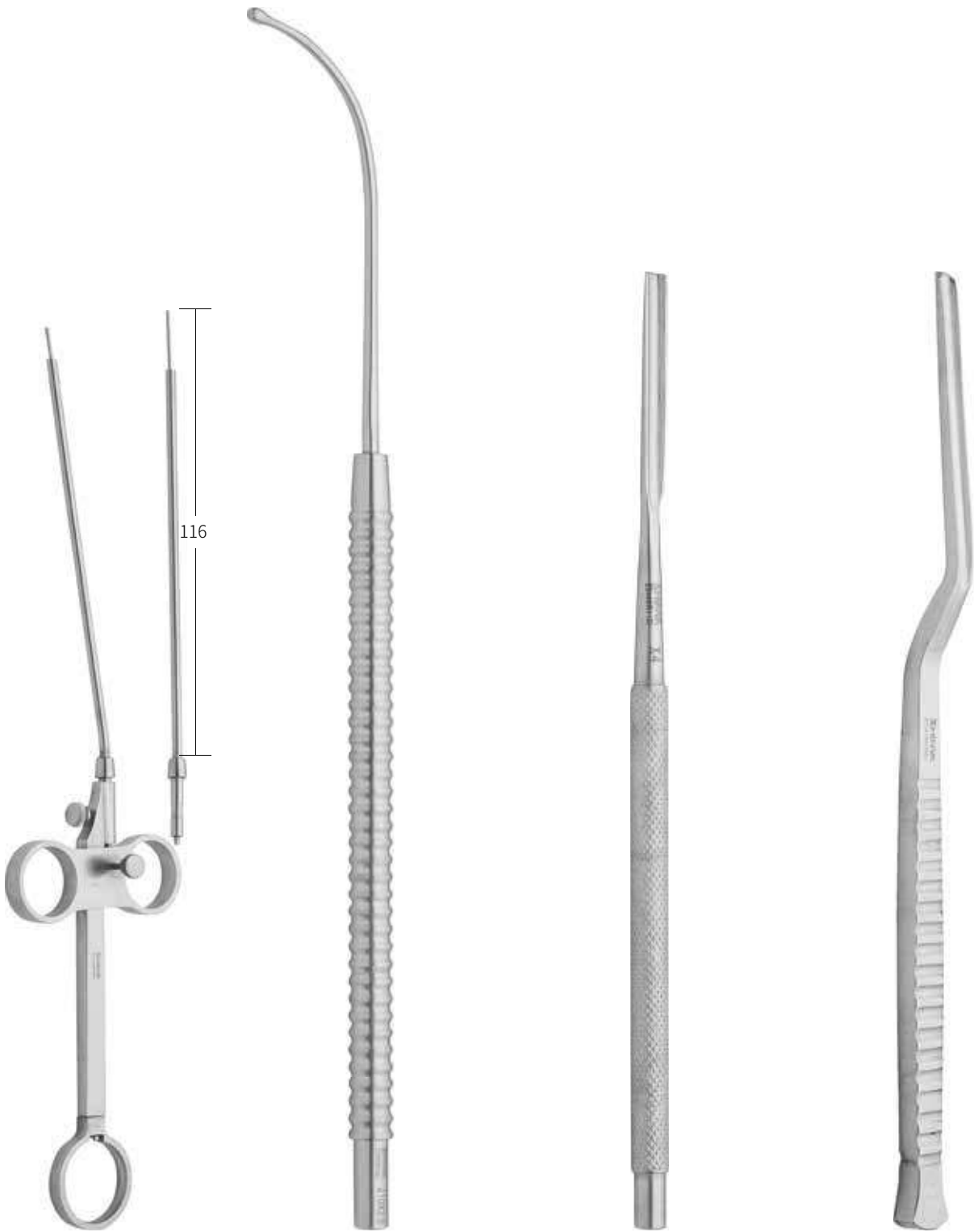

鼻息肉圈断器
Nasal snare

★Z0534R

探针(鼻用)
Nasal probe

★Z01061R 210×Φ2.5,弯,圆头

鼻中隔凿
Nasal septum gouge

★Z0428R 160×3,直形

★Z0440R 160×4,直形

鼻中隔凿
Nasal septum gouge

★Z0407R 160×3,枪形

★Z0409R 160×4,枪形

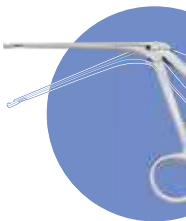

耳鼻喉科
Ear, Nose and Throat Instruments

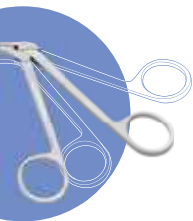

耳鼻喉科
 Ear, Nose and Throat Instruments



鼻中隔凿
 Nasal septum gouge

- ★Z0405R 160×3, 枪形
- ★Z0420R 160×4, 枪形



鼻中隔凿
 Nasal septum gouge

- ★Z0422R 160×4, 直形
- ★Z0404R 160×6, 直形
- Z0421R 160×8, 直形



鼻骨凿
 Ear bone gouge



Z0359RN
 双保护6mm×160

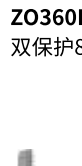

Z0360RN
 双保护8mm×160



Z0361RN
 左保护6mm×160

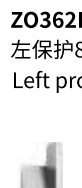

Z0362RN
 左保护8mm×160
 Left protection



Z0363RN
 右保护6mm×160

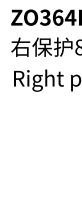

Z0364RN
 右保护8mm×160
 Right protection



鼻粘膜刀(镰状刀)
 Nasal knife



★Z0594RN
 180, 尖头弯, 方柄
 Sharp



★Z0595RN
 180, 钝头弯, 方柄
 Blunt



ZO491RN
 190, 枪形单头镰

ZO492RN
 190, 枪形单头圆

鼻粘膜刀
 Nasal knife



鼻粘膜刀
 Nasal knife

- ★ **ZO477RN** 170×4.5, 直型, 单圆头
- ★ **ZO478RN** 170×4, 直型, 单圆头



鼻粘膜刀
 Nasal knife

- ★ **ZO482RN** 180×3×5



★ **ZO489RN**
 190, 单头, 镰状, 尖
 Sharp

★ **ZO490RN**
 190, 单头, 镰状, 圆
 Blunt

鼻粘膜刀
 Nasal knife

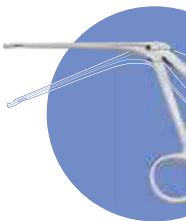

耳鼻喉科
 Ear, Nose and Throat Instruments

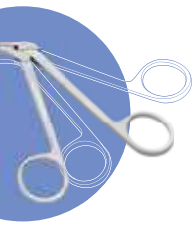

耳鼻咽喉科
Ear, Nose and Throat Instruments



鼻刮匙(鼻增殖体刮匙)
Adenoid curette

- ★Z0382RN 220×8, 无钩
- ★Z0397RN 220×10, 无钩
- ★Z0398RN 220×12, 无钩
- ★Z0677RN 220×15, 无钩
- ★Z0678RN 220×17, 无钩
- ★Z0679RN 220×19, 无钩



鼻中隔旋转刀
Nasal septum knife

- ★Z0445RN 200枪型刃宽3 Blade W 3
- ★Z0446RN 200枪型刃宽4 Blade W 4
- Z0447RN 200枪型刃宽5 Blade W 5



鼻中隔旋转刀
Nasal septum knife

- ★Z0448RN 200直型刃宽3 Blade W 3
- ★Z0444RN 200直型刃宽4 Blade W 4
- Z0449RN 200直型刃宽5 Blade W 5



鼻窥器
Nasal speculum

ZO3884RB
150×28



鼻窥器(鼻镜)
Nasal speculum

- ★ **ZO080R** 150×20
- ★ **ZO081R** 150×28
- ★ **ZO082R** 155×50
- ★ **ZO083R** 160×75

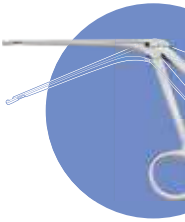

耳鼻喉科
Ear, Nose and Throat Instruments

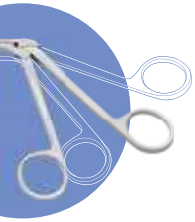

耳鼻喉科
 Ear, Nose and Throat Instruments



鼻中隔剥离器
 Nasal raspatory

★**ZO637RN**
 190×4×15°,
 弯, 单头 Curved

ZO630RN
 190×5,
 弯, 单头 Curved



ZO636RN
 190×4,
 直, 单头 Straight



鼻中隔剥离器
 Nasal raspatory

★**ZO634RN**
 190×4.5,
 弯/直
 Curved/straight



★**ZO632RN**
 220×3.5×4,
 弯/直
 Curved/straight



★**ZO631RN**
 220×3.5×4,
 弯/弯
 Curved/curved



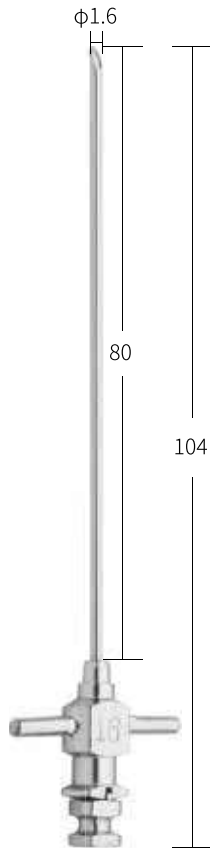
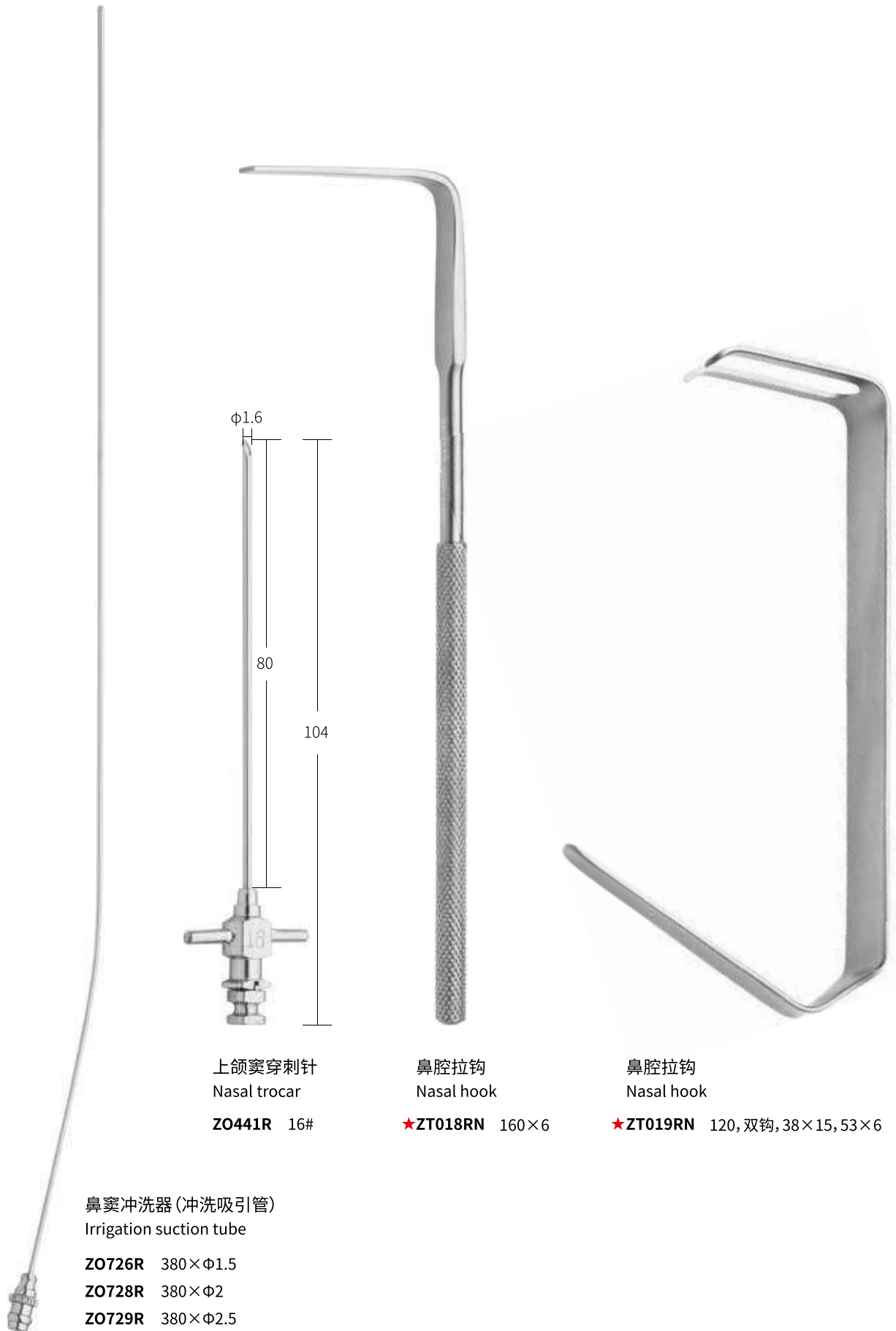

上颌窦穿刺针
Nasal trocar
ZO441R 16#

鼻腔拉钩
Nasal hook
★**ZT018RN** 160×6

鼻腔拉钩
Nasal hook
★**ZT019RN** 120, 双钩, 38×15, 53×6

鼻窦冲洗器(冲洗吸引管)
Irrigation suction tube
ZO726R 380×Φ1.5
ZO728R 380×Φ2
ZO729R 380×Φ2.5

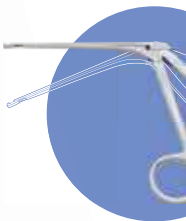

耳鼻喉科
Ear, Nose and Throat Instruments



鼻腔拉钩
Nasal hook
ZT750RB 160×7, 导光

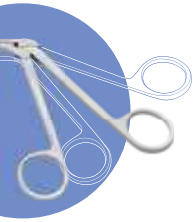

耳鼻喉科
Ear, Nose and Throat Instruments



鼻腔拉钩
Nasal hook
ZO629RN 180, 双头



上颌窦探针
Nasal probe
★**ZO439RN** 190×Φ1×Φ2



上颌窦探针
Nasal probe

Z0627RN 210×1.5×1.5, 角弯



间接喉钳
Laryngeal forceps

★ **Z0737RN** 170, 管式拆卸头 一柄三头 With 3 tips

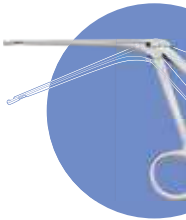

耳鼻喉科
Ear, Nose and Throat Instruments



喉用钳
 Laryngeal forceps



★ZO701RN
 240, 盖板式 上弯三角形



★ZO702RN
 240, 盖板式 直三角形

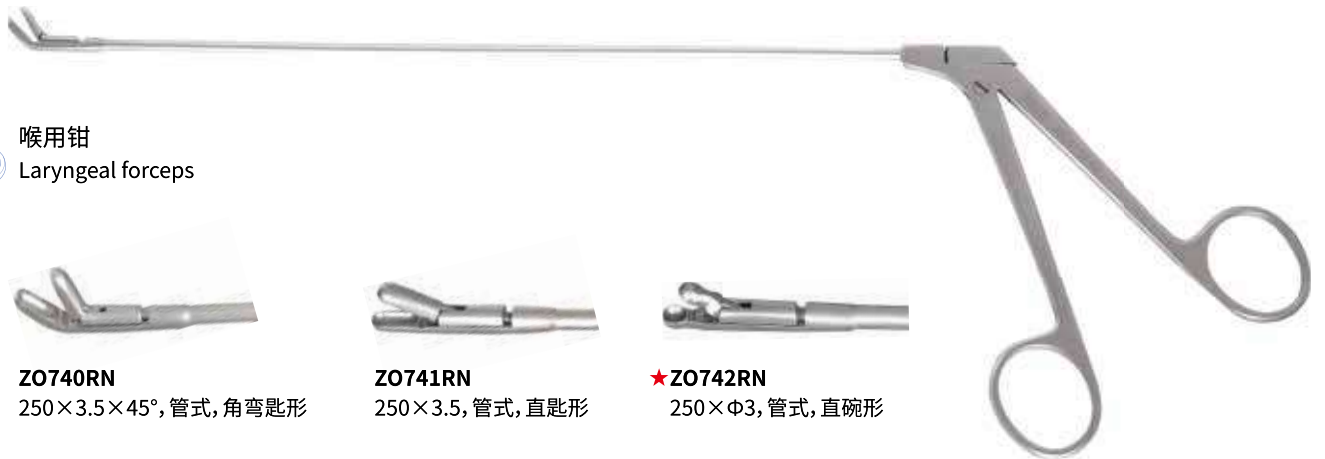

喉用钳
 Laryngeal forceps



ZO740RN
 250×3.5×45°, 管式, 角弯匙形



ZO741RN
 250×3.5, 管式, 直匙形



★ZO742RN
 250×Φ3, 管式, 直碗形



★ZO743RN
 250×Φ3×45°, 管式, 角弯碗形



★ZO744RN
 250×3, 管式, 直三角形



★ZO745RN
 250×3.5×45°, 管式, 角弯三角形



★ZO746RN
 250×4, 管式, 直左腰形
 Left concave



★ZO747RN
 250×4, 管式, 直右腰形
 Right concave



ZO748RN
 280×Φ5, 管式, 直碗形



★ZO749RN
 280×Φ5×45°, 管式, 角弯碗形

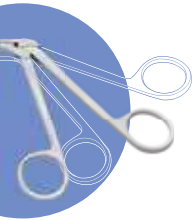

耳鼻咽喉科
 Ear, Nose and Throat Instruments

显微喉剪
Laryngeal scissors



★Z0682RN 230, 盖板式, 直

★Z0684RN 250, 盖板式, 直



★Z0683RN 230, 盖板式, 角弯

★Z0685RN 250, 盖板式, 角弯



间接喉钳
Laryngeal forceps

★Z0718RN 200, 上开 Upward opening

★Z01214RN 200, 下开 Downward opening

★Z01215RN 200, 左开 Left opening

★Z01216RN 200, 右开 Right opening

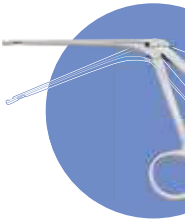

耳鼻喉科
Ear, Nose and Throat Instruments

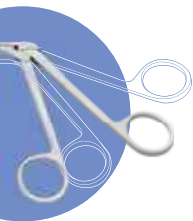

耳鼻咽喉科
Ear, Nose and Throat Instruments

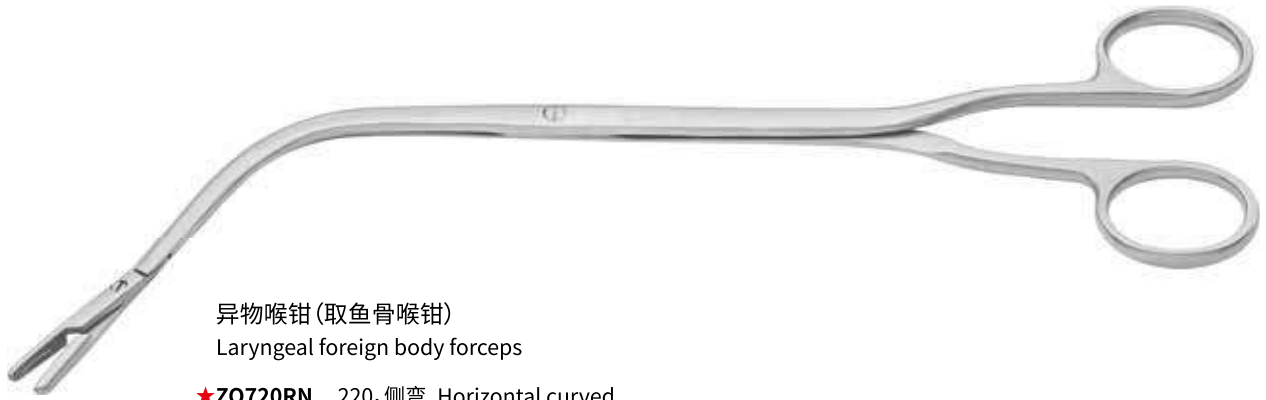

异物喉钳(取鱼骨喉钳)
Laryngeal foreign body forceps

★Z0720RN 220, 侧弯 Horizontal curved

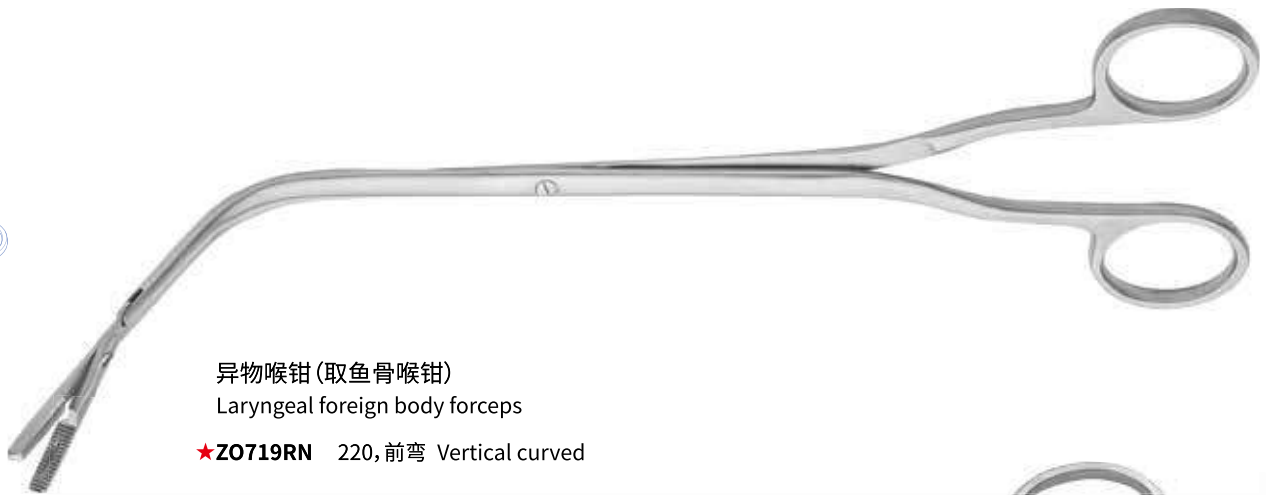

异物喉钳(取鱼骨喉钳)
Laryngeal foreign body forceps

★Z0719RN 220, 前弯 Vertical curved



异物喉钳(取鱼骨喉钳)
Laryngeal foreign body forceps

- ★Z0815RN 220侧弯滑板式 上开 Upward opening
- ★Z0816RN 220侧弯滑板式 下开 Downward opening
- ★Z0817RN 220侧弯滑板式 左开 Left opening
- ★Z0818RN 220侧弯滑板式 右开 Right opening

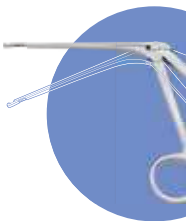
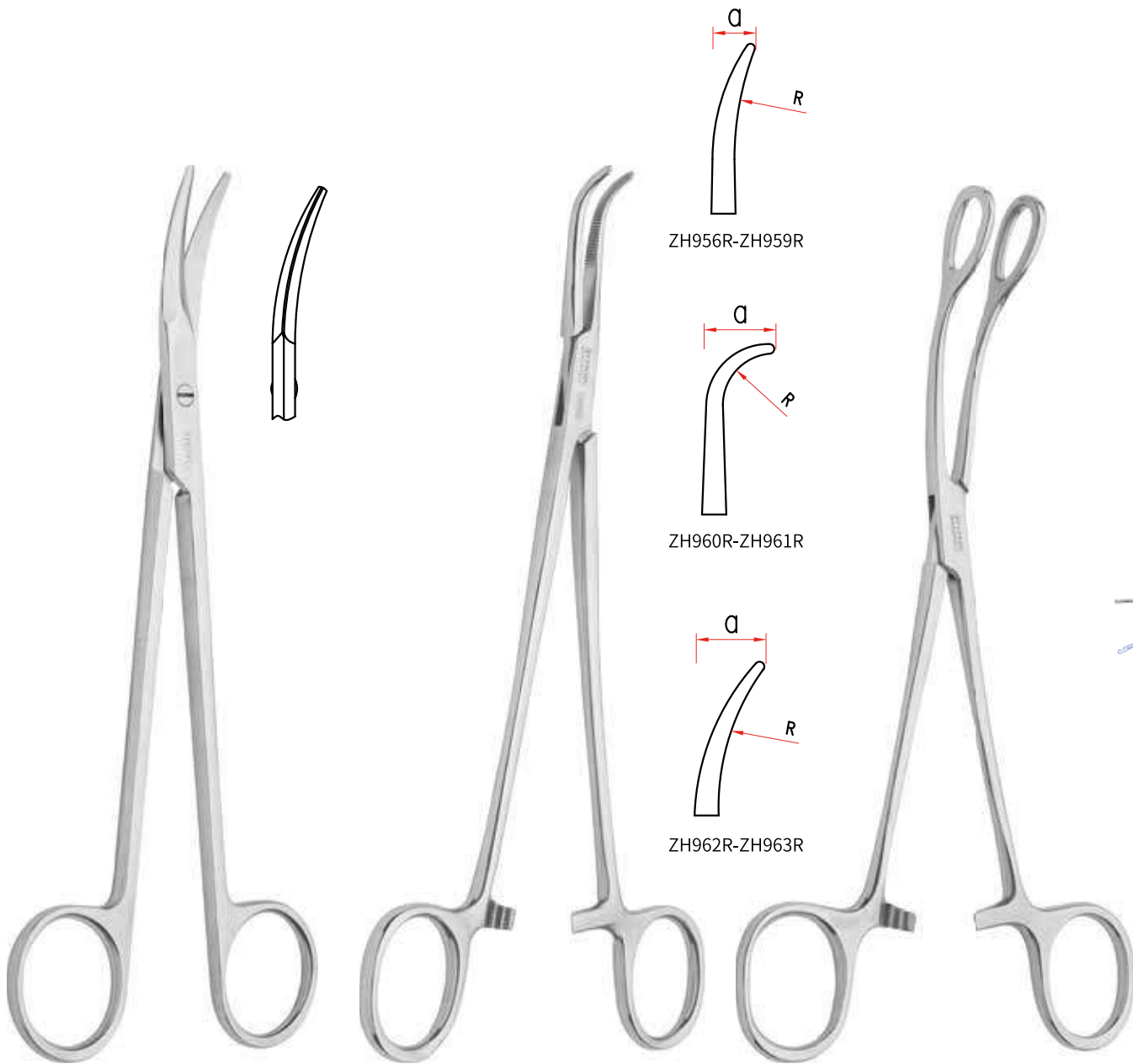

耳鼻喉科
Ear, Nose and Throat Instruments

扁桃体剪
Tonsil scissors, curved

★Z0707R/RN 180, 弯

止血钳(扁桃体用)
Tonsil hemostatic forceps

- ★ZH956R 180×R50×9×2.5, 圆弯头
- ★ZH957R 200×R50×9×2.5, 圆弯头
- ★ZH958R 220×R50×9×2.5, 圆弯头
- ★ZH959R 240×R50×9×2.5, 圆弯头
- ZH960R 180×R12×15×2.5, 圆弯头
- ★ZH961R 200×R12×15×2.5, 圆弯头
- ★ZH962R 220×R50×15×2.5, 圆弯头
- ★ZH963R 240×R50×15×2.5, 圆弯头

海绵钳(扁桃体用)
Tonsil dressing forceps

- ZH952R 180×12, 无齿, 弯 Smooth, curved
- ZH953R 180×12, 无齿, 直 Smooth, straight
- ★ZH954R 180×12, 有齿, 弯 Serrated, curved
- ★ZH955R 180×12, 有齿, 直 Serrated, straight



Z0669R
直型，挤切器，一柄三头 With three tips

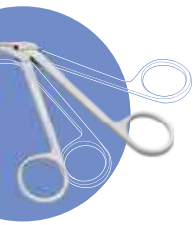

耳鼻喉科
Ear, Nose and Throat Instruments

扁桃切除器
Tonsil snare

★Z0699R 枪形

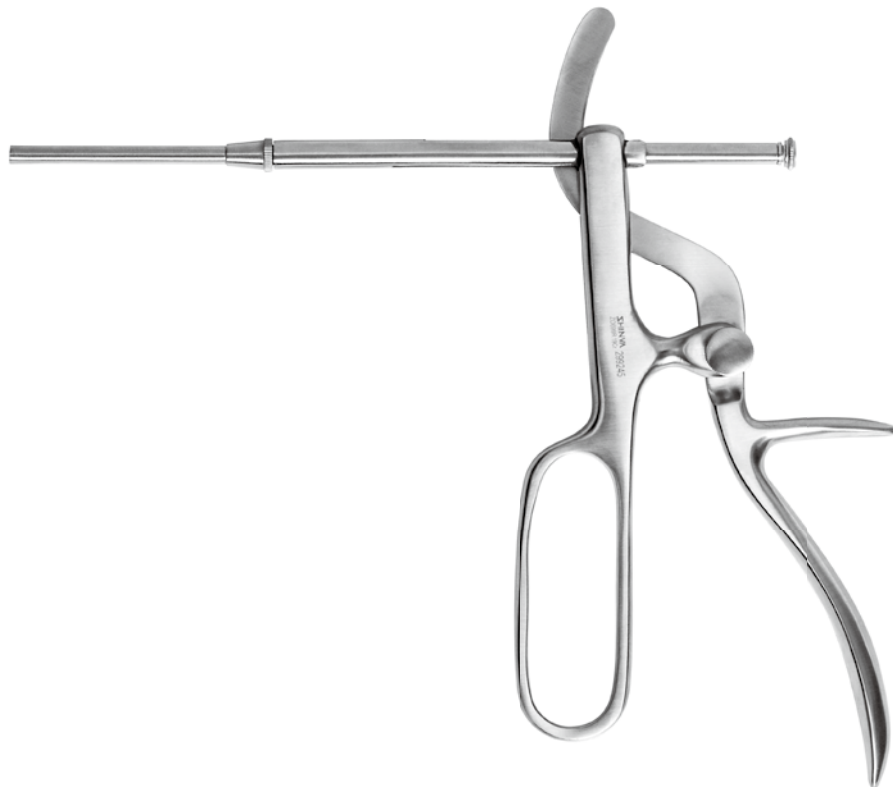



扁桃体用钳(扁桃体夹持钳)
Tonsil grasping forceps

★ Z0670R 220, 多齿, 直形



扁桃体用钳(扁桃体夹持钳)
Tonsil grasping forceps

★ Z0671R 220, 三爪, 直形



扁桃体用钳(扁桃体夹持钳)
Tonsil grasping forceps

★ Z0661R 135×7, 三爪, 枪形

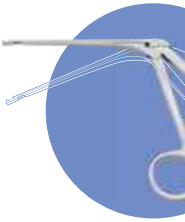

耳鼻喉科
Ear, Nose and Throat Instruments

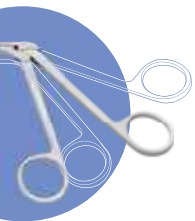

耳鼻咽喉科
 Ear, Nose and Throat Instruments



扁桃体拉钩
 Tonsil retractor

扁桃体拉钩
 Tonsil retractor

拉钩(气管拉钩)
 Retractor

拉钩(气管拉钩)
 Retractor

★Z0662RN 225×12×10

★ZT192R 170

★Z0712R 锐 Sharp

★Z0711R 钝 Curved

★ZT196RN
 160×9, 三爪, 锐
 Sharp

★ZT197RN
 160×9, 三爪, 钝
 Curved

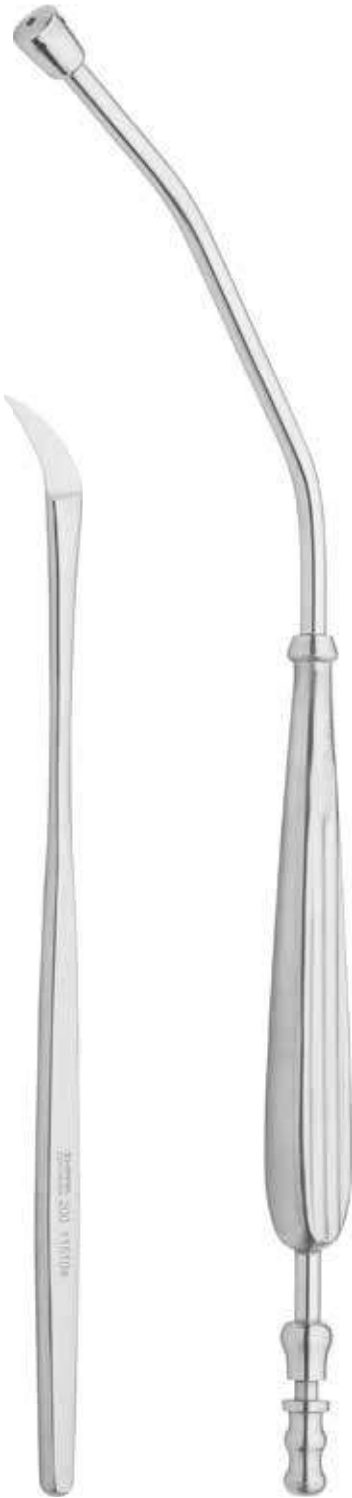

扁桃体刀
Tonsil knife

★Z0672R 200

扁桃体吸引管
Tonsil knife

★Z0673R 280×Φ6



扁桃体圈断器
Tonsil snare

★Z0710R 260, 直型



扁桃体圈断器钢丝
Snare wire

★Z0706R

Φ0.4×10, 一包10根, 一根1米
10pcs/bag, 1 meter/pc



扁桃体穿刺针
Tonsil needle

Z0676R
6# (管Φ1.2, 芯Φ0.6)
弯
Tube 1.2, insert 0.6

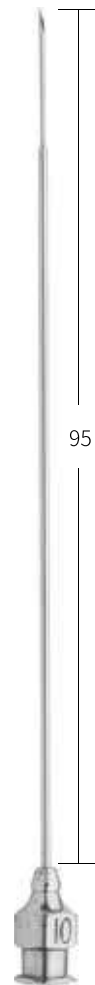

扁桃体穿刺针
Tonsil needle

Z0675R
6# (管Φ1.2, 芯Φ0.6)
直
Tube 1.2, insert 0.6

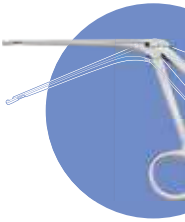

耳鼻喉科
Ear, Nose and Throat Instruments

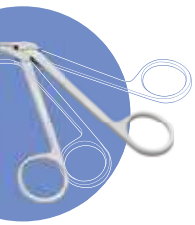

耳鼻咽喉科
 Ear, Nose and Throat Instruments



反光喉镜
 (咽喉镜) (口镜)
 Laryngeal mirror

- ★ZA484R 200, Φ 10 1#
- ★ZA485R 200, Φ 12 2#
- ★ZA486R 200, Φ 14 3#
- ★ZA487R 200, Φ 16 4#
- ★ZA488R 200, Φ 18 5#
- ★ZA489R 200, Φ 20 6#
- ★ZA490R 200, Φ 22 7#



★Z0756R
 160× Φ 2
 螺纹柄三角头

★Z0754R
 160× Φ 1
 螺纹柄螺纹头

★Z0755R
 160× Φ 2
 螺纹柄螺纹头

卷棉子
 Cotton carrier



卷棉子
 Cotton carrier

- ★Z0757R
 160× Φ 1.3, 直柄螺纹头
- ★Z0759R
 180× Φ 1.3, 直柄螺纹头
- ★Z0760R
 180× Φ 2, 直柄螺纹头
- Z0761R
 200× Φ 2, 直柄螺纹头



卷棉子
 Cotton carrier

- ★Z0758R
 160× Φ 2, 直柄三角头
- ZM452R
 200, 直柄三角头



气管套管
Tracheal tubes

- ★ZA104 4#
- ★ZA105 5#
- ★ZA106 6#
- ★ZA107 7#
- ★ZA108 8#
- ★ZA109 9#
- ★ZA110 10#
- ZA159 11#
- ZA158 12#
- ZA157 13#
- ★ZA156 14#



气管扩张钳
Tracheal dilating forceps

- ★ZA005R 150



气管导管夹持钳
Catheter introducing forceps

- ★ZJ023R 成人, 180
Adult



气管导管夹持钳
Catheter introducing forceps

- ★ZJ022R 儿童, 170
Child



气管导管夹持钳
Catheter introducing forceps

- ★ZJ021R 婴幼儿, 140
Infant

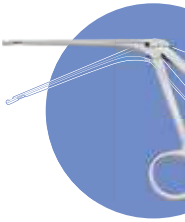

耳鼻喉科
Ear, Nose and Throat Instruments

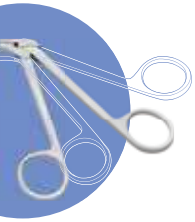

耳鼻咽喉科
Ear, Nose and Throat Instruments



气管扩张钳(三翼)
Tracheal dilating forceps
★ZA009RN 150



气管扩张钳
Tracheal dilating forceps
★ZA003RN 200, 弯型



舌钳
Tongue forceps
★ZA709R 170



甲状腺剪
Valsellum scissors, curved
★ZC632R 180弯



丁字式开口器
Heister mouth gag

★ZO030R 130



口腔开口器 (钳式)
Mouth gag

★ZR809R 120×38, 最大开口36
Max. opening 36



口腔开口器 (框式)
Mouth gag

★ZR812RN (共3把拉钩)
With three retractors

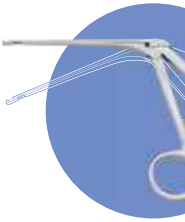

耳鼻喉科
Ear, Nose and Throat Instruments

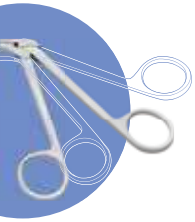

耳鼻喉科
Ear, Nose and Throat Instruments



口腔开口器 (麻醉型)
Mouth gag

★Z0723RN
右式 (共4把拉钩)
Right, with 4 retractors



口腔开口器 (麻醉型)
Mouth gag

★Z0722RN
左式 (共4把拉钩)
Left, with 4 retractors



口腔开口器 (麻醉型)
Mouth gag

★Z0868RN
小儿, 右式
Child, right



口腔开口器 (麻醉型)
Mouth gag

★Z0869RN
小儿, 左式
Child, left

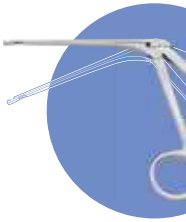

耳鼻喉科
Ear, Nose and Throat Instruments

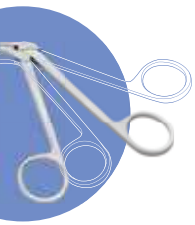

耳鼻咽喉科
Ear, Nose and Throat Instruments



口腔开口器 (麻醉型)
Mouth gag

★Z0867RN
左式 Left

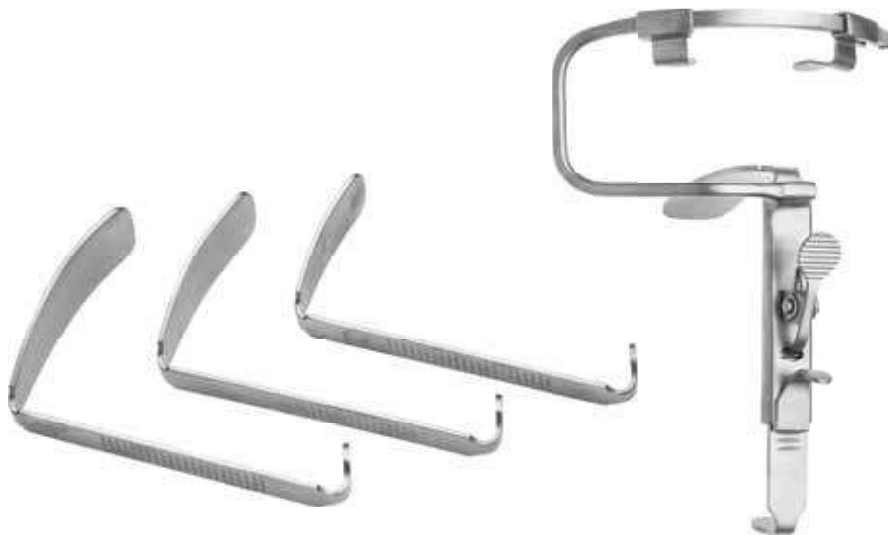

口腔开口器 (麻醉型)
Mouth gag

★Z0866RN
右式 Right



口腔开口器 (麻醉型)
Mouth gag

★ZR813R
左式, 简易型 Left



口腔开口器 (麻醉型)
Mouth gag

★ZR814R
右式, 简易型 Right

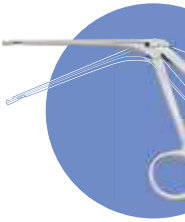

耳鼻喉科
Ear, Nose and Throat Instruments

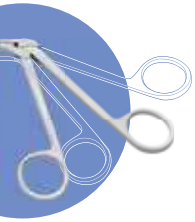

耳鼻喉科
Ear, Nose and Throat Instruments



口腔开口器 (新型)
Mouth gag

ZR810RN
KQ- I 型



口腔开口器 (新型)
Mouth gag

ZR811RN
KQ- II 型

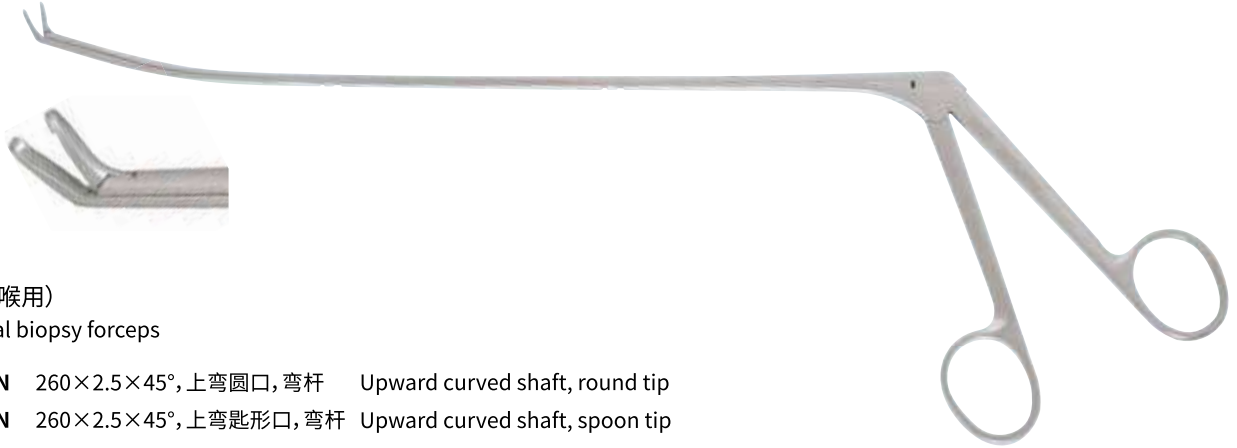

活检钳(喉用)

Laryngeal biopsy forceps

ZO780RN 260×2.5×45°, 上弯圆口, 弯杆 Upward curved shaft, round tip

ZO782RN 260×2.5×45°, 上弯匙形口, 弯杆 Upward curved shaft, spoon tip



活检钳(喉用)

Laryngeal biopsy forceps



ZO779RN 260×2.5×45°, 上弯圆口, 直杆 Straight shaft, round tip

ZO781RN 260×2.5×45°, 上弯匙形口, 直杆 Straight shaft, spoon tip



ZO783RN 260×4×45°, 上弯三角形

耳鼻喉科
Ear, Nose and Throat Instruments



异物喉钳

Laryngeal foreign body forceps

ZO778RN 280×3, 直齿头, 右开口 Right opening

ZO777RN 280×3, 直齿头, 左开口 Left opening

ZO776RN 280×3, 直齿头, 下开口 Downward opening

ZO775RN 280×3, 直齿头, 上开口 Upward opening

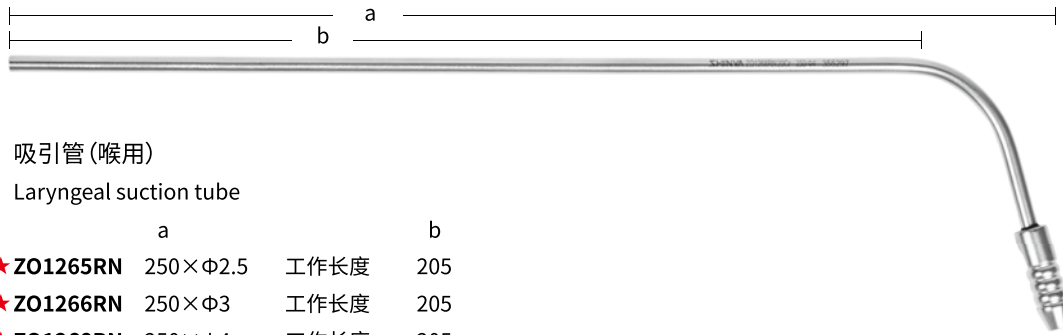

吸引管 (喉用)

Laryngeal suction tube

	a		b
★ Z01265RN	250×Φ2.5	工作长度	205
★ Z01266RN	250×Φ3	工作长度	205
★ Z01268RN	250×Φ4	工作长度	205

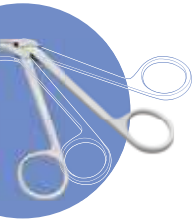

耳鼻咽喉科
 Ear, Nose and Throat Instruments

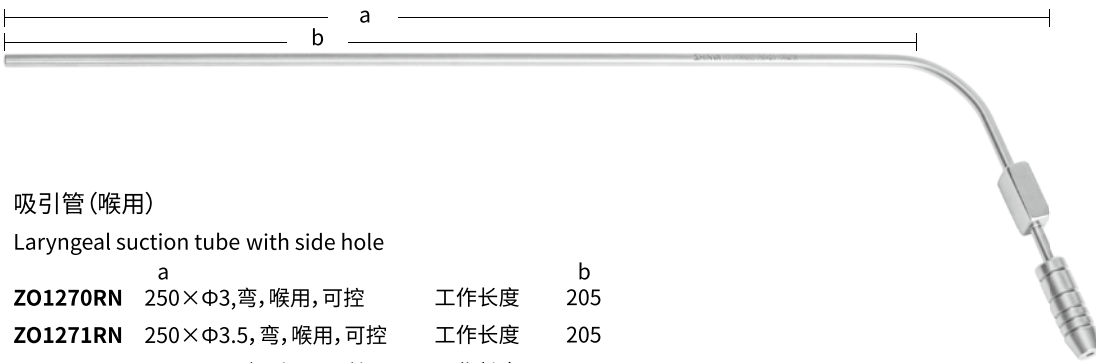

吸引管 (喉用)

Laryngeal suction tube with side hole

	a		b
Z01270RN	250×Φ3, 弯, 喉用, 可控	工作长度	205
Z01271RN	250×Φ3.5, 弯, 喉用, 可控	工作长度	205
Z01272RN	250×Φ4, 弯, 喉用, 可控	工作长度	205

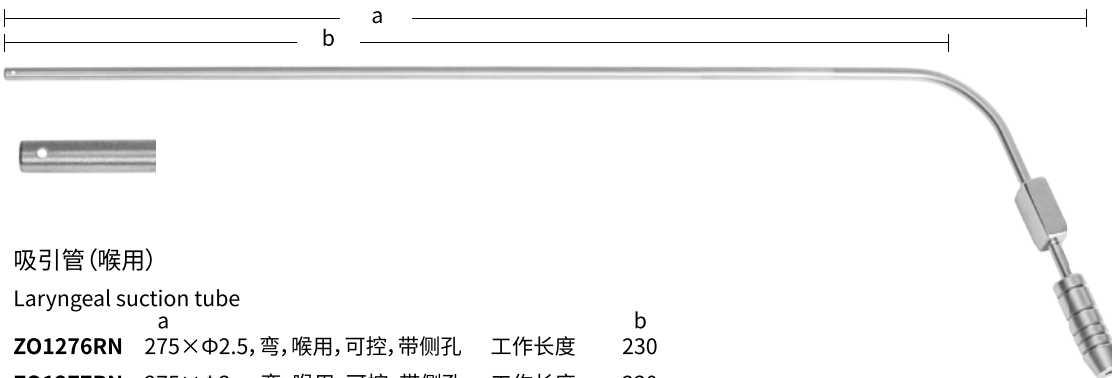

吸引管 (喉用)

Laryngeal suction tube

	a		b
Z01276RN	275×Φ2.5, 弯, 喉用, 可控, 带侧孔	工作长度	230
Z01277RN	275×Φ3, 弯, 喉用, 可控, 带侧孔	工作长度	230
Z01278RN	275×Φ3.5, 弯, 喉用, 可控, 带侧孔	工作长度	230
Z01279RN	275×Φ4, 弯, 喉用, 可控, 带侧孔	工作长度	230



异物钳 (气管异物钳)
 Tracheal foreign body forceps



Z0792RN
 360×Φ2.5, 反二爪式



Z0793RN
 360×Φ2.5, 三爪式



Z0794RN
 360×Φ2.5, 三爪取笔套式



Z0795RN
 360×2.5×Φ2.5, 前爪口



Z0796RN
 360×2.5×Φ2.5, 花生米头



Z0797RN
 360×3×Φ2.5, 二爪式



Z0798RN
 360×3×Φ2.5, 环形口

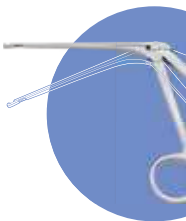

异物钳 (气管异物钳)
 Tracheal foreign body forceps



Z0784RN
 360×2.5×Φ2, 锯齿头



Z0785RN
 360×2.5×Φ2, 圆口



Z0786RN
 360×2.5×Φ2, 麦粒头



Z0787RN
 360×2.5×Φ2, 取珠式



Z0788RN
 360×2.5×Φ2, 环形头



Z0789RN
 360×Φ2, 取笔套式



Z0790RN
 360×Φ2, 鳄鱼头



Z0791RN
 360×Φ2, 尖头式

耳鼻喉科
 Ear, Nose and Throat Instruments

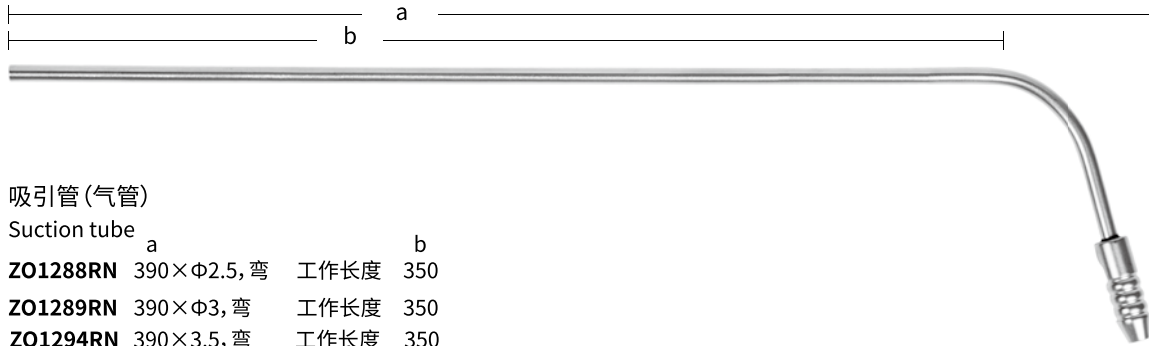

吸引管(气管)

Suction tube

	a	工作长度	b
ZO1288RN	390×Φ2.5, 弯	350	350
ZO1289RN	390×Φ3, 弯	350	350
ZO1294RN	390×Φ3.5, 弯	350	350
ZO1290RN	390×Φ4, 弯	350	350

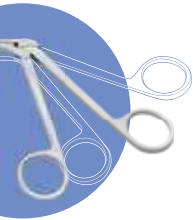

耳鼻喉科
 Ear, Nose and Throat Instruments



食道贲门狭窄扩张器
 Cardia expander

ZO3959R	9×13×250	ZO3962R	12×17×380
ZO3960R	10×15×300	ZO3963R	13×18×400
ZO3961R	11×16×350		



快装手柄
 Quick coupling handle

ZO3964R 105, 可换 Exchangable



异物钳 (气管异物钳)
Tracheal foreign body forceps

- ZO807RN** 350×Φ4, 倒齿头, 可转式
- ZO808RN** 380×Φ4, 倒齿头, 可转式
- ZO809RN** 450×Φ4, 倒齿头, 可转式
- ZO810RN** 500×Φ4, 倒齿头, 可转式



异物钳 (气管异物钳)
Tracheal foreign body forceps



- ZO799RN** 350×Φ4, 鳄嘴头
- ZO800RN** 380×Φ4, 鳄嘴头
- ZO801RN** 450×Φ4, 鳄嘴头
- ZO802RN** 500×Φ4, 鳄嘴头

- ZO811RN** 350×Φ4, 抱合头
- ZO812RN** 380×Φ4, 抱合头
- ZO813RN** 450×Φ4, 抱合头
- ZO814RN** 500×Φ4, 抱合头

- ZO803RN** 350×Φ4, 倒齿头
- ZO804RN** 380×Φ4, 倒齿头
- ZO805RN** 450×Φ4, 倒齿头
- ZO806RN** 500×Φ4, 倒齿头

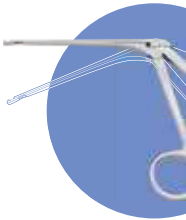

耳鼻喉科
Ear, Nose and Throat Instruments

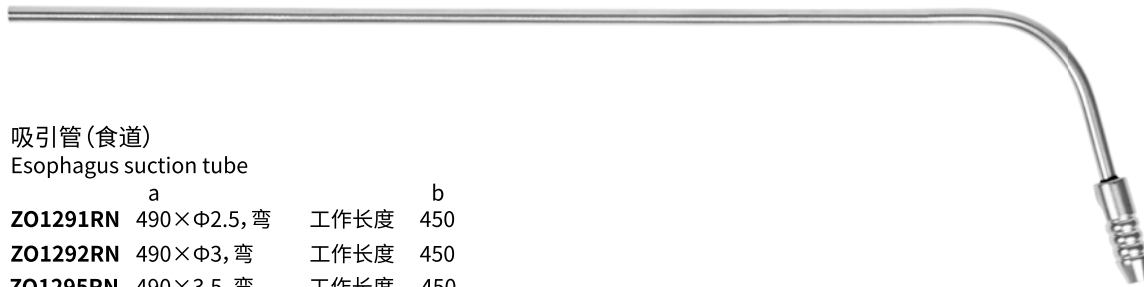
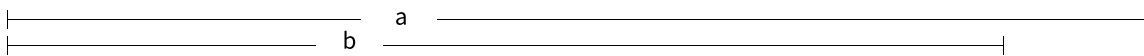

吸引管 (食道)
Esophagus suction tube

- | | a | | b |
|-----------------|-------------|------|-----|
| ZO1291RN | 490×Φ2.5, 弯 | 工作长度 | 450 |
| ZO1292RN | 490×Φ3, 弯 | 工作长度 | 450 |
| ZO1295RN | 490×Φ3.5, 弯 | 工作长度 | 450 |
| ZO1293RN | 490×Φ4, 弯 | 工作长度 | 450 |



手术剪 (食道剪)
Esophagus scissors

- ZO820RN** 450×Φ3.5, 管式, 直



息肉钳 (食道息肉钳)
 Esophagus forceps, bowl-shape
 upwards curved 45°

ZO644RN 450×Φ3.5, 上翘45°, 碗形



活检钳 (食道活检钳)
 Esophagus forceps, bowl-shape
 right curved

ZO641RN 450×Φ3.5, 右弯, 碗形



异物钳 (食道异物钳)
 Esophagus foreign body forceps

ZO819RN 380×Φ4, 切除



活检钳 (食道活检钳)
 Esophagus forceps, bowl-shape
 left curved

ZO640RN 450×Φ3.5, 左弯, 碗形

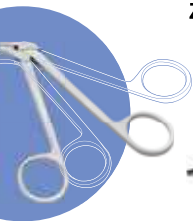

耳鼻喉科
 Ear, Nose and Throat Instruments



息肉钳 (食道息肉钳)
 Esophagus forceps

ZO643RN 450×Φ3.5, 右弯, 匙形
 Right curved



ZO645RN 450×Φ3.5, 直, 匙形
 Straight



活检钳 (食道活检钳)
 Esophagus forceps, bowl-shape

ZO642RN 450×Φ3.5, 旋转, 碗形 Rotatable





测深器
Depth gauge
ZO357R 50



测量器
Gauge
ZO151R 125



环甲膜穿刺针
Cricothyroid needle
D × h
ZO090R $\Phi 2 \times 46$
LS409R $\Phi 2.5 \times 46$
ZO091R $\Phi 3 \times 46$
LS499R $\Phi 6.0 \times 48$



注射针
Needle
ZA255 5.5#

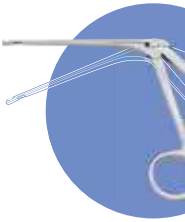

耳鼻喉科
Ear, Nose and Throat Instruments

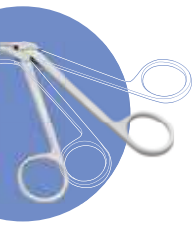

耳鼻咽喉科
Ear, Nose and Throat Instruments



压舌板
Tongue depressor

★Z0204R 170



压舌板
Tongue depressor

★Z0203R 160



压舌板
Tongue depressor, right angle

★Z0611R 直角形



甲状腺拉钩
Retractor

★ZT024R/RN
95, 10×20/10×29, 一副
2 pcs/pair



甲状腺拉钩
Retractor

★ZT025R/RG
117, 10×23/10×35
★ZT026R/RG
120, 10×25/10×37
★ZT028R/RN
(117, 120) 一副 2 pcs/pair
ZT040R
126, 9×23/12×32 一副
2 pcs/pair

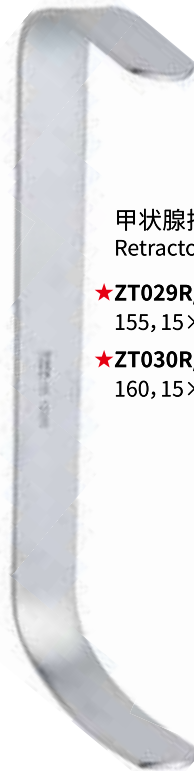

甲状腺拉钩
Retractor

★ZT029R/RN
155, 15×33/15×42
★ZT030R/RN
160, 15×38/15×47



甲状腺拉钩
Retractor

★ZT031R
200, 13×39/13×43
一副, 带槽 2 pcs/pair
ZT035R
210, 15×30/15×45
一副, 带槽 2 pcs/pair

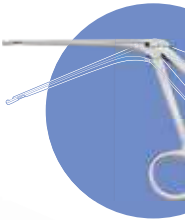

耳鼻喉科
Ear, Nose and Throat Instruments

编码后缀注释: R—电镀 RN—亚光无镀层 RB—刷光无镀层

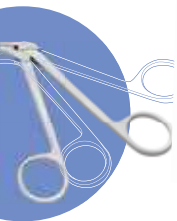

耳
鼻
喉
科
Ear, Nose and Throat Instruments

DW- I 型耳鼻喉科手术器械包(丁种外科器械包) (ZO100)

DW-I ENT Surgical Instruments set

序号	编码	名 称	规 格	单 位	数 量
1	ZH110R	止血钳	125,直蚊,全齿	把	2
2	ZH145R	止血钳	140,弯,全齿	把	2
3	ZH443R	止血钳	160,弯,全齿	把	2
4	ZM240R	持针钳	140,直,细针	把	1
5	ZA709R	舌钳	170,直	把	1
6	ZB084R	手术刀柄	4#	把	1
7	ZB077R	手术刀柄	7#	把	1
8	ZC344R	手术剪	140,直尖	把	1
9	ZC414R	手术剪	140,弯圆	把	1
10	ZD045R	医用镊	125,直	把	6
11	ZO030R	丁字式开口器	130	把	1
12	ZO081R	鼻窥器	150×28	把	1
13	ZM113R	探针	120,双头	支	1
14	ZO203R	压舌板	160,直形	块	1
15	ZR022R	牙用镊	160,单弯,有定位	把	1



QG- I 型气管切开手术器械(ZA100)
QG- I tracheotomy instruments set

序号	编码	名称	规格	单位	数量
1	ZH110R	止血钳	125,直蚊	把	3
2	ZH111R	止血钳	125,弯蚊	把	3
3	ZH144R	止血钳	140,直全	把	3
4	ZH145R	止血钳	140,弯全	把	3
5	ZH443R	止血钳	160,弯全	把	1
6	ZM240R	持针钳	140,细针	把	1
7	ZD045R	医用镊	125	把	1
8	ZD047R	医用镊	140	把	2
9	ZD557R	组织镊	140,不锈钢	把	1
10	ZE432R	帕巾钳	110	把	4
11	ZC547R	组织剪	180,直	把	1
12	ZB073R	手术刀柄	3#	把	1
13	ZB077R	手术刀柄	7#	把	1
14	ZB515	手术刀片	15#	包	1

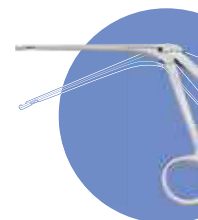

耳鼻喉科
Ear, Nose and Throat Instruments

序号	编 码	名 称	规 格	单 位	数 量
15	ZA005R	气管扩张钳	150	把	1
16	ZT028R	甲状腺拉钩	(117, 120) 一副	副	1
17	ZT192R	拉钩	170, 气管	把	2
18	ZA107	气管套管	7#	套	1
19	ZA108	气管套管	8#	套	1
20	ZA109	气管套管	9#	套	1
21	ZA110	气管套管	10#	套	1

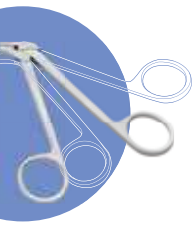

耳鼻咽喉科
Ear, Nose and Throat Instruments



环甲膜切开成套手术器械 (ZA101)
Cricothyroid instruments set

序号	产品编码	产品名称	规格型号	数量	单位
1	ZB073R	手术刀柄	3#	1	把
2	ZB077R	手术刀柄	7#	1	把
3	ZA005R	气管扩张钳	150, 弯型	1	把
4	ZH144R	止血钳	140, 直, 全齿	1	把
5	ZH145R	止血钳	140, 弯, 全齿	1	把
6	ZO090R	经皮穿刺针	2.1*41 (环甲膜)	1	把
7	ZO091R	经皮穿刺针	3.0*41 (环甲膜)	1	把
8	LS409R	经皮穿刺针	2.4*41 (环甲膜)	1	把
9	ZB515	手术刀片	15#	1	包

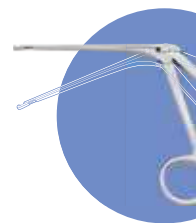

耳鼻喉科
Ear, Nose and Throat Instruments



JM-I型静脉切开手术器械包(ZB140)
 JM-I venotomy instruments set

序号	编码	名称	规格	单位	数量
1	ZH110R	止血钳	125,直蚊	把	1
2	ZH111R	止血钳	125,弯蚊	把	1
3	ZE431R	帕巾钳	90	把	2
4	ZC056R	眼用剪	100,直尖	把	1
5	ZB073R	手术刀柄	3#	把	1
6	ZD555R	组织镊	125,不锈钢	把	1
7	ZB515	手术刀片	15#	包	1
8	ZT184R	拉钩	200×13,静脉	把	1
9	ZM666R	缝合针	1/2,弯三角,8×20	包	1

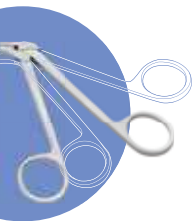

耳鼻咽喉科
 Ear, Nose and Throat Instruments



EK-I 型耳科显微手术器械包明细表 (ZO199)
EK-I ear surgical instruments set

序号	编码	名称	规格	单位	数量
1	ZO183R	显微剥离器	160×1, 弯型, 叶片状	把	1
2	ZO184R	耳刮匙	160×1.8, 单头, 圆头	把	1
3	ZO185R	耳刮匙	160×2, 单头, 圆头	把	1
4	ZO176R	耳道皮瓣刀	160×2.5×45°, 角弯	把	1
5	ZO187R	耳道皮瓣刀	160×2.4 耳横切口	把	1
6	ZO188R	显微剥离器	160×0.9 右弯, 耳开窗	把	1
7	ZO189R	显微剥离器	160×0.9 左弯, 耳开窗	把	1
8	ZO190R	耳用骨凿	160×1.7×0.85, 直, 圆刃	把	1
9	ZO191R	耳用骨凿	160×2×1.6, 弯, 圆刃	把	1
10	ZO192R	耳用骨凿	160×0.6×0.3, 直, 平刃	把	1
11	ZO193R	显微耳针	160×1, 直型, 尖头	把	1
12	ZO182R	耳道皮瓣刀	160, 镰状	把	1
13	ZO195R	耳道皮瓣刀	160×2.2, 直型, 耳切口	把	1
14	ZO196R	耳道皮瓣刀	160×1.2, 直型, 耳开窗	把	1
15	ZO197R	耳道皮瓣刀	160×1.2, 弯型, 耳开窗	把	1
16	ZO123R	显微耳针	160, 直型, 尖头	把	1
17	ZO205R	耳钩	160×2, 直形, 角弯90°, 钝钩	把	1
18	ZO206R	耳钩	160×2, 直形, 角弯90°, 锐钩	把	1

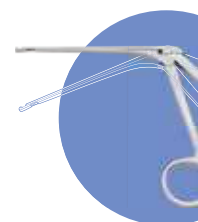

耳鼻喉科
Ear, Nose and Throat Instruments

序号	编码	名称	规格	单位	数量
19	ZO207R	耳钩	160×1.5,直形,角弯120°,锐钩	把	1
20	ZO208R	耳钩	160×1.5,直形,角弯95°,锐钩	把	1
21	ZO209R	耳钩	160×2.5,直形,角弯95°,锐钩	把	1



EK-II型耳科显微手术器械包明细表 (ZO201)
EK-II ear surgical instruments set

序号	编码	名称	规格	单位	数量
1	ZO123R	显微耳针	160,直型,尖头	把	1
2	ZO124R	显微耳针	160×45°,角弯,尖头	把	1
3	ZO125R	显微耳钩	160×0.3×90°,直型	把	1
4	ZO126R	显微耳钩	160×0.6×90°,直型	把	1
5	ZO127R	显微耳钩	160×1×90°,直型	把	1
6	ZO128R	显微耳针	160×0.5,直型,尖头	把	1
7	ZO138R	耳用骨凿	160×2×1,直,圆刃	把	1
8	ZO149R	吸引头	50,微型	个	2
9	ZO150R	骨撬	145,直型,耳用	把	1
10	ZO151R	测深器	125	把	1
11	ZO152R	耳刮匙	160×2,单头,椭圆头	把	1
12	ZO153R	耳刮匙	160×2,双头	把	1

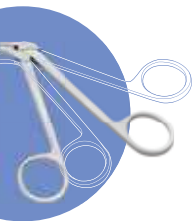

耳鼻咽喉科
Ear, Nose and Throat Instruments

序号	编码	名称	规格	单位	数量
13	ZO154R	耳刮匙	160×1.5, 双头	把	1
14	ZO164R	显微剥离器	160×1.5, 弯型, 叶片状	把	1
15	ZO165R	显微剥离器	160×2, 弯型, 叶片状	把	1
16	ZO176R	耳道皮瓣刀	160×2.5×45°, 角弯	把	1
17	ZO182R	耳道皮瓣刀	160, 镰状	把	1
18	ZO210R	耳道皮瓣刀	160×2.5, 直型	把	1
19	ZO211R	耳道皮瓣刀	160×2×45°, 角弯	把	1
20	ZO132R	乳突牵开器	130, 3×3钩, 钝钩, 固定式	把	1
21	ZV073RG	乳突牵开器	170×21, 3×3钝钩, 活节带齿	把	2
22	ZO173R	镫骨足弓剪	75, 左上翘	把	1
23	ZO174R	镫骨足弓剪	75, 右上翘	把	1
24	ZO169R	镫骨钳	80, 安装用	把	1
25	ZO181R	耳用槌骨咬骨剪	80, 直	把	1
26	ZO166R	耳钳	80, 直, 橄榄形, 显微	把	1
27	ZO167R	耳钳	80, 直, 碗形, 显微	把	1
28	ZO168R	耳钳	80, 直, 麦粒形, 显微	把	1
29	ZO3820RB	耳剪	80, 直	把	1

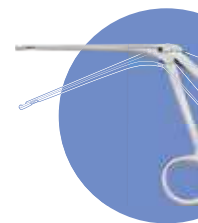

耳鼻喉科
Ear, Nose and Throat Instruments

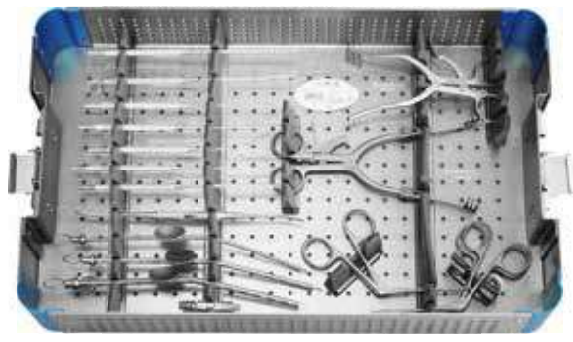

EKV-III型耳科显微手术器械包明细表 (ZO202)
EKV-III ear surgical instruments set

序号	编码	名称	规格	单位	数量
1	ZO126R	耳钩	160×0.6	把	1
2	ZO138R	耳用骨凿	160×2×1, 圆刃	把	1
3	ZO150R	骨撬	145, 直, 耳用	把	1
4	ZO165R	显微剥离器	160×2, 剥离子	把	1
5	ZO176R	耳道皮瓣刀	160×2.5×45°角弯	把	1
6	ZO132R	乳突牵开器	130, 固定式, 3×3钩, 钝钩	把	1
7	ZV073RG	乳突牵开器	170×21, 3×3钝钩	把	1
8	ZO181R	耳用锤骨咬骨剪	80	把	1
9	ZO166R	耳钳	80, 显微, 橄榄形	把	1
10	ZO168R	耳钳	80, 显微, 直麦粒形	把	1
11	ZO3820RB	耳剪	80, 直	把	1
12	ZO207R	耳钩	160×1.5, 角弯120°	把	1
13	ZO208R	耳钩	160×1.5, 角弯95°	把	1
14	ZO122R	鼻骨膜剥离器	190×4×4, 弯	把	1
15	ZO149R	吸引头	50	把	1
16	ZO135R	吸引管	190×φ3, 乳突	把	1
17	ZO136R	吸引管	190×φ4, 乳突	把	1
18	ZO137R	吸引管	190×φ5, 乳突	把	1

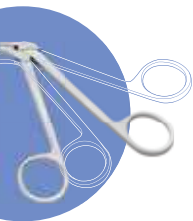

耳鼻咽喉科
Ear, Nose and Throat Instruments



耳道皮瓣刀套装 (ZO3818)
Ear flap knives set

序号	产品编码	产品名称	规格型号	数量	单位
1	ZO3801RB	耳道皮瓣刀	160×1×45°, 角弯	1	把
2	ZO3802RB	耳道皮瓣刀	160×1.2×45°, 角弯	1	把
3	ZO3803RB	耳道皮瓣刀	160×1.5×45°, 角弯	1	把
4	ZO3804RB	耳道皮瓣刀	160×1.8×45°, 角弯	1	把
5	ZO3805RB	耳道皮瓣刀	160×2×45°, 角弯	1	把
6	ZO3806RB	耳道皮瓣刀	160×2.5×45°, 角弯	1	把
7	ZO3807RB	耳道皮瓣刀	160×3×45°, 角弯	1	把
8	ZO3808RB	耳道皮瓣刀	160×1×90°, 角弯	1	把
9	ZO3809RB	耳道皮瓣刀	160×1.2×90°, 角弯	1	把
10	ZO3810RB	耳道皮瓣刀	160×1.5×90°, 角弯	1	把
11	ZO3811RB	耳道皮瓣刀	160×1.8×90°, 角弯	1	把
12	ZO3812RB	耳道皮瓣刀	160×2×90°, 角弯	1	把
13	ZO3813RB	耳道皮瓣刀	160×2.5×90°, 角弯	1	把
14	ZO3814RB	耳道皮瓣刀	160×2, 直型	1	把
15	ZO3815RB	耳道皮瓣刀	160×2.5, 直型	1	把
16	ZO3816RB	耳道皮瓣刀	160, 镰状	1	把
17	ZO3817RB	耳道皮瓣刀	160, 镰状	1	把
18	ZO20027P	消毒盒	262×162×42 双层	1	个

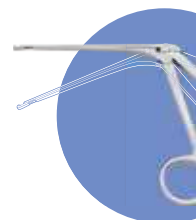

耳鼻喉科
Ear, Nose and Throat Instruments



BDQ- I 型鼻窦专用手术器械明细表 (ZO1000)
BDQ-I nasal surgical instruments set

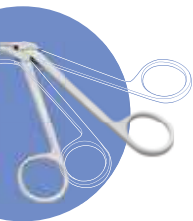

耳鼻喉科
Ear, Nose and Throat Instruments

序号	编码	名称	规格	单位	数量
1	ZO555RN	鼻组织剪	120, 管式, 直形	把	1
2	ZO556RN	鼻组织剪	120, 管式, 左弯	把	1
3	ZO557RN	鼻组织剪	120, 管式, 右弯	把	1
4	ZO558RN	鼻咬切钳	120×1.5, 盖板式, 直型, 正切	把	1
5	ZO559RN	鼻咬切钳	120×2, 盖板式, 直型, 反切	把	1
6	ZO3500RN	鼻组织钳	120×3, 盖板式, 直, 尖圆头	把	1
7	ZO3576RN	鼻组织钳	120×3, 盖板式, 角弯, 30°尖圆头	把	1
8	ZO3502RN	鼻组织钳	120×3, 盖板式, 角弯, 45°, 尖圆头	把	1
9	ZO3505RN	鼻组织钳	120×4, 盖板式, 角弯, 90°, 尖圆头	把	1
10	ZO574RN	鼻组织钳	120×4, 盖板式, 直, 长圆头	把	1
11	ZO517RN	鼻咽活体取样钳	140×70°, 管式, 角弯, 长圆头, 横开	把	1
12	ZO519RN	鼻咽活体取样钳	140×100°, 管式, 角弯, 长圆头, 横开	把	1
13	ZO516RN	鼻咽活体取样钳	140×70°, 管式, 角弯, 长圆头, 竖开	把	1
14	ZO514RN	鼻咽活体取样钳	140, 直形, 管式, 长圆头, 竖开	把	1
15	ZO581RN	鼻咽活体取样钳	150×3, 直形, 管式, 左开口	把	1
16	ZO582RN	鼻咽活体取样钳	150×3, 直形, 管式, 右开口	把	1
17	ZO586RN	鼻咽活体取样钳	170×3×90°, 角弯, 管式带吸	把	1
18	ZO311RN	上颌窦咬骨钳	150×4, 上切口	把	1
19	ZO588RN	鼻咬切钳	120×3, 盖板式, 直型, 长圆头, 鼻开筛	把	1
20	ZO590RN	鼻咬切钳	120×3×30°, 盖板式, 角弯, 长圆头, 鼻开筛	把	1

序号	编 码	名 称	规 格	单 位	数 量
21	ZO591RN	鼻腔吸引管	150×Φ3×24, 弯	支	1
22	ZO532RN	鼻腔吸引管	130×Φ2.5×55°×78	支	1
23	ZO592RN	鼻腔吸引管	130×Φ3×55°×78	支	1
24	ZO533RN	鼻腔吸引管	130×Φ4×55°×78	支	1
25	ZO523RN	鼻刮匙	190×4.5, 单头, 角弯, 匙形	支	1
26	ZO1010RN	鼻刮匙	190×4.5, 角弯15°, 碗形, 有孔	支	1
27	ZO593RN	鼻骨膜剥离器	190×4.5, 单头, 微弯	支	1
28	ZO594RN	鼻粘膜刀	180, 镰状尖	支	1
29	ZO595RN	鼻粘膜刀	180, 镰状圆	支	1
30	ZO598RN	鼻穿刺针	170×Φ4, 斜口	支	1

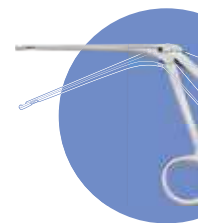

耳鼻喉科
 Ear, Nose and Throat Instruments



鼻科专用器械套装 (ZO3658)
Nasal instruments set

序号	产品编码	产品名称	规格型号	数量	单位
1	ZO3640RB	鼻组织钳	130×3.5, 管式, 直, 尖头	1	把
2	ZO3641RB	鼻组织钳	130×3.5×30°, 管式, 角弯, 尖头	1	把
3	ZO3642RB	鼻组织钳	130×3.5×45°, 管式, 角弯, 尖头	1	把
4	ZO3643RB	鼻组织钳	140×3.5, 管式, 上弯, 115°, 尖头	1	把
5	ZO3644RB	鼻组织钳	135×3.5, 管式, 上弯, 90°, 尖头	1	把
6	ZO3645RB	鼻组织钳	140×3.5, 管式, 下弯, 115°, 尖头	1	把
7	ZO3646RB	鼻组织钳	135×3.5, 管式, 下弯, 90°, 尖头	1	把
8	ZO3647RB	鼻咬切钳	130×3, 管式, 直型, 尖头	1	把
9	ZO3648RB	鼻咬切钳	130×3×30°, 管式, 角弯, 尖头	1	把
10	ZO3649RB	鼻咬切钳	130×3×45°, 管式, 角弯, 尖头	1	把
11	ZO3650RB	鼻咬切钳	130×3, 管式, 直型, 长圆头	1	把
12	ZO3651RB	鼻咬切钳	130×3×30°, 管式, 角弯, 长圆头	1	把
13	ZO3652RB	鼻咬切钳	130×3×45°, 管式, 角弯, 长圆头	1	把
14	ZO3653RB	鼻咬切钳	130×1.8, 管式, 直型, 反切	1	把
15	ZO3654RB	鼻咬切钳	130×2.5, 管式, 直型, 反切	1	把
16	ZO3655RB	鼻组织剪	130, 直形, 管式	1	把
17	ZO3656RB	鼻组织剪	130, 左弯, 管式	1	把
18	ZO3657RB	鼻组织剪	130, 右弯, 管式	1	把

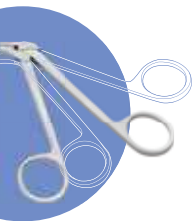

耳鼻喉科
Ear, Nose and Throat Instruments



BQC-I 型扁桃体切除手术器械包 ZO680
BQC-I Tonsillectomy instruments set

序号	产品编码	产品名称	规格型号	数量	单位
1	ZB077R	手术刀柄	7#	1	把
2	ZO707R	扁桃体剪	180, 弯型	1	把
3	ZE017R	组织钳	180, 直	2	把
4	ZH957R	止血钳	200×R50×9×2.5, 圆弯头, 扁桃体	1	把
5	ZH956R	止血钳	180×R50×9×2.5, 圆弯头, 扁桃体	1	把
6	ZH958R	止血钳	220×R50×9×2.5, 圆弯头, 扁桃体	1	把
7	ZO671R	扁桃体用钳	220, 三爪, 直形	1	把
8	ZM236R	持针钳	180, 直, 粗针	1	把
9	ZE433R	帕巾钳	140, 尖头	2	把
10	ZO662RN	扁桃体拉钩	225, 双头, 扁桃体拉钩及剥离子	1	把
11	ZO710R	扁桃体切除器	260, 直形, 圈断器	1	把
12	ZO706R	扁桃体切除器	Φ0.4×10, 圈断器钢丝	1	把
13	ZR813R	口腔开口器	麻醉, 左式	1	把
14	ZH954R	海绵钳	180×12, 弯有齿, 扁桃体	1	把
15	ZE117R	海绵钳	250×8, 弯有齿	1	把
16	ZO611R	压舌板	120, 直角形	1	把
17	ZO673R	扁桃体吸引管	280, 管径 Φ6	1	把
18	ZO136R	吸引管	190×Φ4, 弯, 乳突	1	把
19	ZD053R	医用镊	220, 直	1	把
20	ZO677RN	鼻刮匙	220×15, 无钩, 鼻增殖体刮匙	1	把
21	ZO398RN	鼻刮匙	220×12, 无钩, 鼻增殖体刮匙	1	把

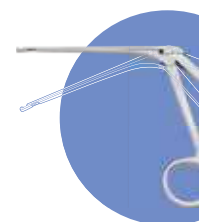

耳鼻喉科
Ear, Nose and Throat Instruments



HX- III型喉科显微外科手术器械包 (ZO1400)
HX-III Throat instruments set

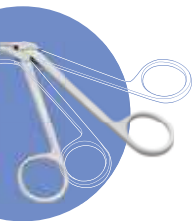

耳鼻咽喉科
Ear, Nose and Throat Instruments

序号	产品编码	产品名称	规格型号	数量	单位
1	ZO3823RB	显微喉钳	230×2, 管式, 直型, 圆头	1	把
2	ZO3824RB	显微喉钳	230×2, 管式, 上弯, 圆头	1	把
3	ZO3825RB	显微喉钳	230×2, 管式, 左弯, 圆头	1	把
4	ZO3826RB	显微喉钳	230×2, 管式, 右弯, 圆头	1	把
5	ZO3827RB	显微喉钳	230×2, 管式, 直型, 有齿	1	把
6	ZO3828RB	显微喉钳	230×2, 管式, 上弯, 45°, 有齿	1	把
7	ZO3829RB	显微喉钳	230×2.2, 管式, 直型, 三角头	1	把
8	ZO3830RB	显微喉钳	230×2.2, 管式, 上弯, 45°, 三角头	1	把
9	ZO3831RB	显微喉钳	230×2, 管式, 直型, 卵圆型	1	把
10	ZO3832RB	显微喉钳	230×2, 管式, 上弯, 卵圆型	1	把
11	ZO3833RB	显微喉钳	230×2, 管式, 左弯, 卵圆型	1	把
12	ZO3834RB	显微喉钳	230×2, 管式, 右弯, 卵圆型	1	把
13	ZO1241RB	显微喉剪	250, 管式, 直型	1	把
14	ZO1242RB	显微喉剪	250×45°, 管式, 上弯	1	把
15	ZO1243RB	显微喉剪	250, 管式, 右弯	1	把
16	ZO1244RB	显微喉剪	250, 管式, 左弯	1	把
17	ZO3846RB	显微喉刀	245, 直形, 镰刀	1	把
18	ZO3847RB	显微喉刀	245, 直形, 三角刃	1	把
19	ZO3848RB	显微喉刀	245, 直形, 圆刃	1	把
20	ZO3849RB	显微喉刀	245, 角弯, 圆刃	1	把
21	ZO3850RB	显微喉刀	245, 直形, 圆刃	1	把
22	ZO3851RB	显微喉钩	245, 圆弯	1	把

序号	产品编码	产品名称	规格型号	数量	单位
23	ZO3852RB	剥离器	245, 圆头, 微弯	1	把
24	ZO3853RB	结扎缝合引线器	245	1	把
25	ZO3854RB	显微喉针	245, 直型, 球头	1	把
26	ZO3855RB	显微喉针	245, 角弯, 45°, 球头	1	把
27	ZO3856RB	显微喉针	245, 角弯, 90°, 球头	1	把
28	ZO3857RB	喉显微手术器械手柄	与喉钩、喉刀、喉针配用, 可换	1	把
29	ZO1276RN	吸引管	275×Φ2.5, 弯, 喉用, 可控	1	把
30	ZO1277RN	吸引管	275×Φ3, 弯, 喉用, 可控	1	把
31	ZO1278RN	吸引管	275×Φ3.5, 弯, 喉用, 可控	1	把
32	ZO1279RN	吸引管	275×Φ4, 弯, 喉用, 可控	1	把
33	ZO1201RN	支撑喉镜	支撑架	1	把
34	ZO1202RN	支撑喉镜	大号	1	把
35	ZO1203RN	支撑喉镜	小号	1	把
36	ZO1221RN	支撑喉镜	带光纤	1	把

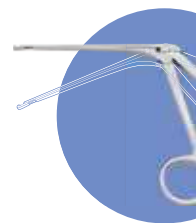

耳鼻喉科
 Ear, Nose and Throat Instruments

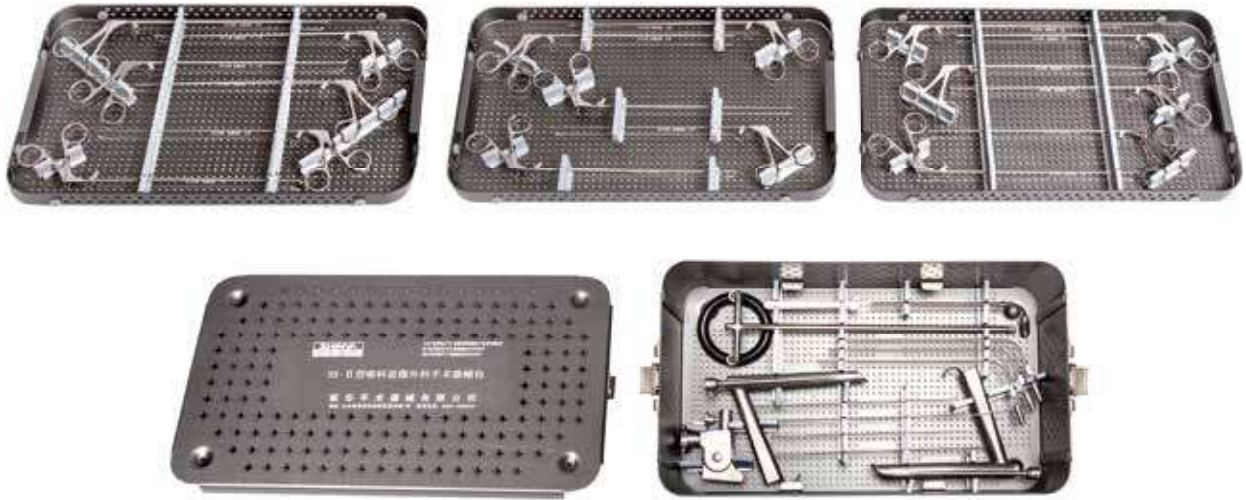

HX- II 型喉科显微外科手术器械包ZO1225
HX- II type Throat surgical instruments

序号	编码	名称	规格	单位	数量
1	JO1180RB	显微喉钳	230×φ2, 管式, 直型, 圆头	把	1
2	JO1181RB	显微喉钳	230×φ2, 管式, 上弯, 圆头	把	1
3	JO1182RB	显微喉钳	230×φ2, 管式, 右弯, 圆头	把	1
4	JO1183RB	显微喉钳	230×φ2, 管式, 左弯, 圆头	把	1
5	JO1184RB	显微喉钳	230×1, 管式, 直型, 麦粒形	把	1
6	JO1185RB	显微喉钳	230×1, 管式, 右弯, 麦粒形	把	1
7	JO1186RB	显微喉钳	230×1, 管式, 左弯, 麦粒形	把	1
8	JO1187RB	显微喉钳	230×1, 管式, 上弯, 麦粒形	把	1
9	JO1188RB	显微喉钳	230×3, 管式, 角弯, 右弯, 抓取型	把	1
10	JO1189RB	显微喉钳	230×2, 管式, 角弯, 右弯, 抓取型	把	1
11	JO1190RB	显微喉钳	230×3, 管式, 角弯, 左弯, 抓取型	把	1
12	JO1191RB	显微喉钳	230×2, 管式, 角弯, 左弯, 抓取型	把	1
13	JO1249RB	显微喉剪	230, 管式, 直型	把	1
14	JO1250RB	显微喉剪	230×45°, 管式, 上弯	把	1
15	JO1251RB	显微喉剪	230×15°, 管式, 上弯	把	1
16	JO1252RB	显微喉剪	230, 管式, 右弯	把	1
17	JO1253RB	显微喉剪	230, 管式, 左弯	把	1
18	ZO1201RN	支撑喉镜	支撑架	件	1
19	ZO1202RN	支撑喉镜	大号	件	1
20	ZO1203RN	支撑喉镜	小号	件	1
21	ZO1221RN	支撑喉镜	带光纤	件	1
22	ZO1270RN	吸引管	250×φ3, 弯, 喉用, 可控	把	1
23	ZO1271RN	吸引管	250×φ3.5, 弯, 喉用, 可控	把	1
24	ZO1272RN	吸引管	250×φ4, 弯, 喉用, 可控	把	1
25	ZO724RN	显微喉针	250, 角弯	把	1
26	ZO725RN	显微喉刀	250, 三角刃, 直形	把	1
27	ZO727RN	显微喉钩	250, 圆弯, 双爪	把	1
28	ZO767RN	显微喉刀	250, 镰刃, 直形	把	1
29	ZO768RN	喉显微手术器械手柄	与喉钩、喉刀、喉针配用, 可换	把	1

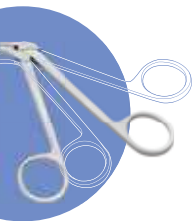

耳鼻喉科
Ear, Nose and Throat Instruments