

Thoracoscopic Small Incision Instruments
胸腔镜小切口器械

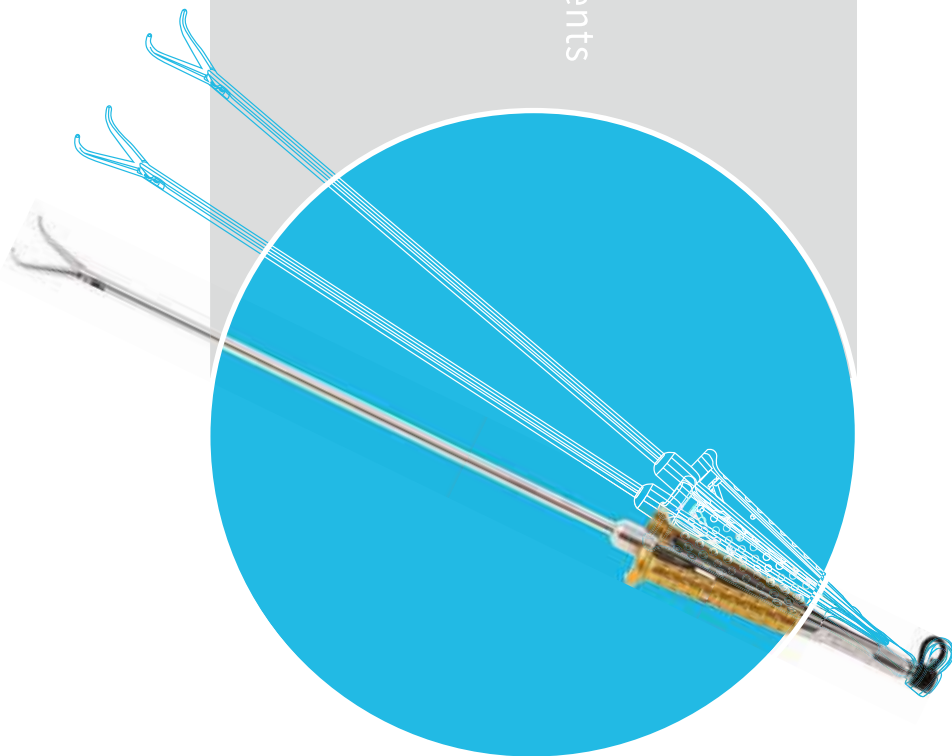

QUALITY
OUR WAY TO SUCCESS

Thoracoscopic Small Incision Instruments

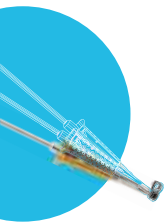

胸腔镜小切口器械
 Thoracoscopic Small Incision Instruments

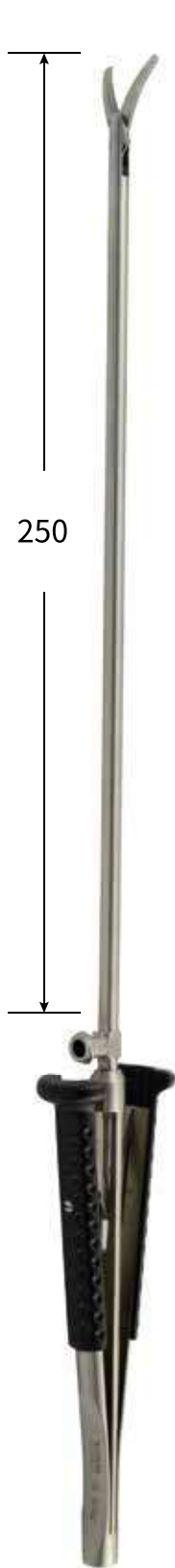

精细剪
 Delicate scissors

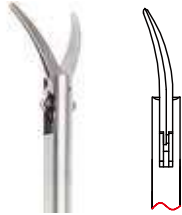

★ **JP1610RB**
 250, 弯, 双开, 握笔管式
 Double action

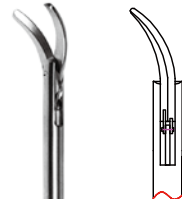

★ **JP1613RB**
 250, 弯, 双开, 握笔管式
 Double action



★ **JP1622RB**
 250, 弯45°, 单开, 握笔管式
 Single action



★ **JP1625RB**
 250, 弯90°, 单开, 握笔管式
 Single action



★ **JP1628RB**
 250, 弯125°, 单开, 握笔管式
 Single action

小切口持针钳
 Small incision needle holder



★ **JP1658RB**
 250, 直, 单开, 握笔管式
 Single action,
 with diamond dust



★ **JP1643RB**
 250, 直, 单开, 镶片, 握笔管式
 Single action,TC



★ **JP1646RB**
 250, 弯, 单开, 镶片, 握笔管式
 Single action,TC



夹持钳
Grasping forceps

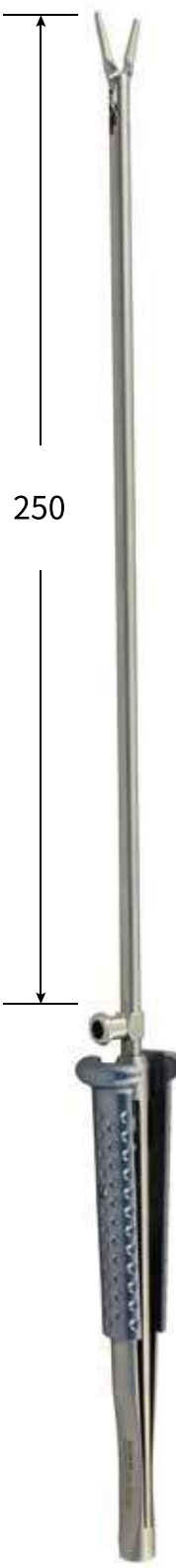





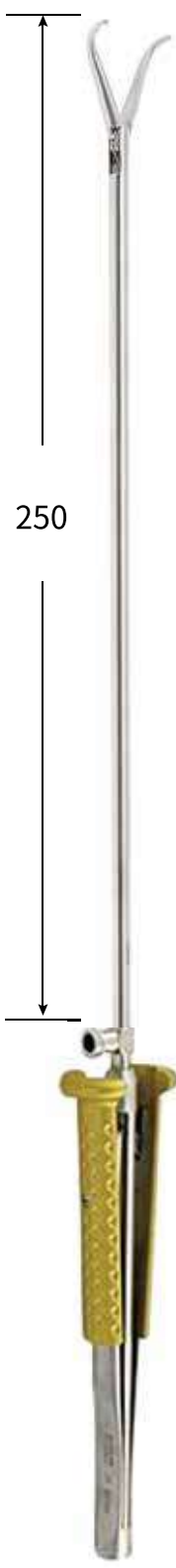



250

分离结扎钳
Dissecting and ligature forceps



250

 <p>★ JP1667RB 250×1.5, 1×2凹凸齿, 直头, 双开, 握笔管式 Double action, atraumatic</p>	 <p>★ JP1676RB 250×3, 直头, 单开, 握笔管式 Single action</p>	 <p>★ JP1700RB 250, 弯, 双开, 握笔管式 Double action</p>
 <p>★ JP1670RB 250×1.5, 1×2凹凸齿, 上翘45°, 双开, 握笔管式 Double action, atraumatic</p>	 <p>★ JP1673RB 250×2.8, 1×2凹凸齿, 直头, 双开, 握笔管式 Double action, atraumatic</p>	
 <p>★ JP1685RB 250×1.5, 1×2凹凸齿, 角弯, 单开, 握笔管式 Single action, atraumatic</p>	 <p>★ JP1703RB 250, 握笔管式 Titanium clip applier, small</p>	
 <p>★ JP1691RB 250, 上翘45°, 单开, 握笔管式 Single action</p>	 <p>★ JP1706RB 250, 握笔管式 Titanium clip applier, large</p>	
 <p>★ JP1694RB 250, 直型, 单开, 握笔管式 Single action</p>		

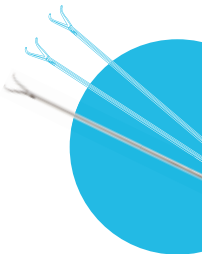

胸腔镜小切口器械
 Thoracoscopic Small Incision Instruments

单孔型 血管钳

Vascular clamp, single action

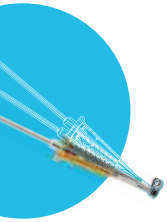

胸腔镜小切口器械
Thoracoscopic Small Incision Instruments



ZP1592RB

420×10, 滑板式, 圆弯, 1×2齿, 6mm杆径
Shaft 6mm



ZP1500RB

330×15, 滑板式, 圆弯, 1×2齿, 5mm杆径
Shaft 5mm

ZP1501RB

330×15, 滑板式, 圆弯, 1×2齿,
无锁止牙, 5mm杆径
Shaft 5mm, without ratchet

★ **ZP1567RB**

360×15, 滑板式, 圆弯, 1×2齿, 6mm杆径
Shaft 6mm

ZP1593RB

420×15, 滑板式, 圆弯, 1×2齿, 6mm杆径
Shaft 6mm



ZP1502RB

330×20, 滑板式, 圆弯, 1×2齿, 5mm杆径
Shaft 5mm

ZP1503RB

330×20, 滑板式, 圆弯, 1×2齿,
无锁止牙, 5mm杆径
Shaft 5mm, without ratchet

★ **ZP1568RB**

360×20, 滑板式, 圆弯, 1×2齿, 6mm杆径
Shaft 6mm

ZP1594RB

420×20, 滑板式, 圆弯, 1×2齿, 6mm杆径
Shaft 6mm



单孔型 血管钳
Vascular clamp, single action

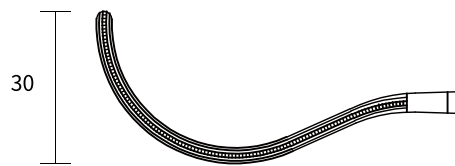
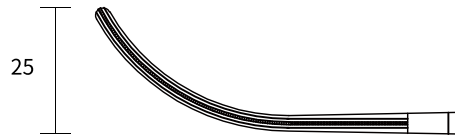

ZP1504RB

330×25, 滑板式, 圆弯, 1×2齿, 5mm杆径
Shaft 5mm

ZP1505RB

330×25, 滑板式, 圆弯, 1×2齿,
无锁止牙, 5mm杆径
Shaft 5mm, without ratchet

★ **ZP1569RB**

360×25, 滑板式, 圆弯, 1×2齿, 6mm杆径
Shaft 6mm

ZP1595RB

420×25, 滑板式, 圆弯, 1×2齿, 6mm杆径
Shaft 6mm

ZP1506RB

330×25×90°, 滑板式, 弯, 1×2齿, 5mm杆径
Shaft 5mm

ZP1507RB

330×25×90°, 滑板式, 弯, 1×2齿,
无锁止牙, 5mm杆径
Shaft 5mm, without ratchet

★ **ZP1570RB**

360×25×90°, 滑板式, 弯, 1×2齿, 6mm杆径
Shaft 6mm

ZP1596RB

420×25×90°, 滑板式, 弯, 1×2齿, 6mm杆径
Shaft 6mm

ZP1555RB

330×18×90°, 滑板式, 弯, 1×2齿, 5mm杆径
Shaft 5mm

ZP1556RB

330×18×90°, 滑板式, 弯, 1×2齿,
无锁止牙, 5mm杆径
Shaft 5mm, without ratchet

★ **ZP1571RB**

360×18×90°, 滑板式, 弯, 1×2齿, 6mm杆径
Shaft 6mm

ZP1591RB

420×20×90°, 滑板式, 弯, 1×2齿, 6mm杆径
Shaft 6mm

ZP1508RB

330×75×30, 滑板式, 圆弯, 1×2齿, 5mm杆径
Shaft 5mm

ZP1509RB

330×75×30, 滑板式, 圆弯, 1×2齿,
无锁止牙, 5mm杆径
Shaft 5mm, without ratchet

★ **ZP1572RB**

360×75×30, 滑板式, 圆弯, 1×2齿, 6mm杆径
Shaft 6mm

ZP1600RB

420×75×30, 滑板式, 圆弯, 1×2齿, 6mm杆径
Shaft 6mm

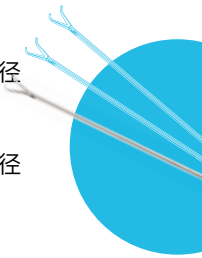

胸腔镜小切口器械
Thoracoscopic Small Incision Instruments

单孔型 血管钳

Vascular clamp, single action, with ratchet

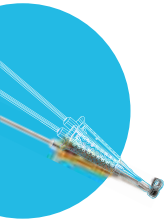

胸腔镜小切口器械
Thoracoscopic Small Incision Instruments

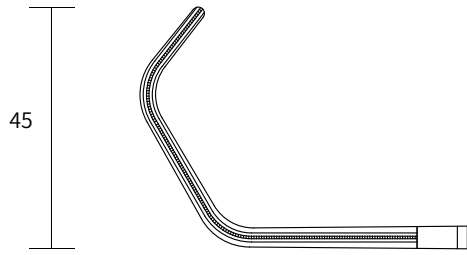

★ **ZP1601RB**
350×48, 滑板式,
双角弯, 1×2齿, 6mm杆径
Shaft 6mm

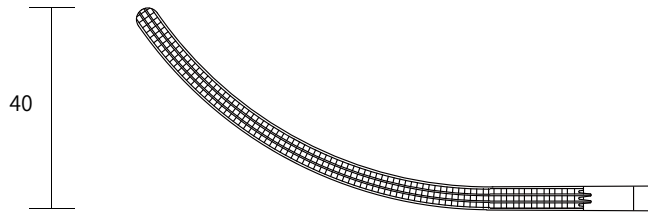

★ **ZP1580RB**
360×40, 滑板式,
弯, 2×3齿, 6mm杆径
Shaft 6mm



★ **ZP1581RB**
360×15×110°,
滑板式, 弯, 1×2齿,
6mm杆径
Shaft 6mm



★ **ZP1585RB**
360×15×135°,
滑板式, 弯, 1×2齿,
6mm杆径
Shaft 6mm



单孔型 血管钳

Vascular clamp, double action, shaft 6mm

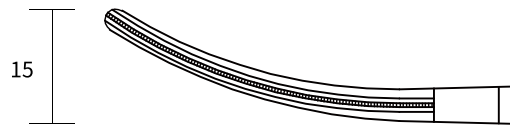

ZP1526RB

330×15, 滑板式, 圆弯,
1×2齿, 双开, 6mm杆径

ZP1527RB

330×15, 滑板式, 圆弯,
1×2齿, 双开, 无锁止牙, 6mm杆径
Without ratchet

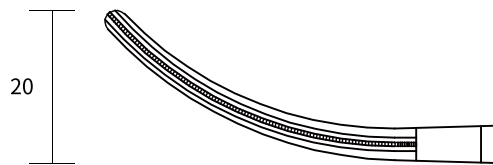

ZP1528RB

330×20, 滑板式, 圆弯,
1×2齿, 双开, 6mm杆径

ZP1529RB

330×20, 滑板式, 圆弯,
1×2齿, 双开, 无锁止牙, 6mm杆径
Without ratchet

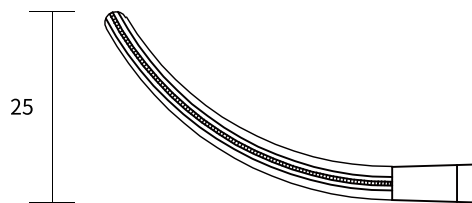

ZP1530RB

330×25, 滑板式, 圆弯,
1×2齿, 双开, 6mm杆径

ZP1531RB

330×25, 滑板式, 圆弯,
1×2齿, 双开, 无锁止牙, 6mm杆径
Without ratchet

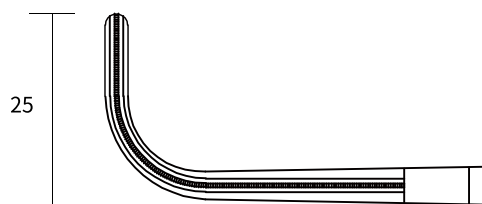

ZP1532RB

330×25×90°, 滑板式, 圆弯,
1×2齿, 双开, 6mm杆径

ZP1533RB

330×25×90°, 滑板式, 圆弯,
1×2齿, 双开, 无锁止牙, 6mm杆径
Without ratchet

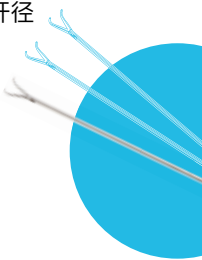

胸腔镜小切口器械
Thoracoscopic Small Incision Instruments

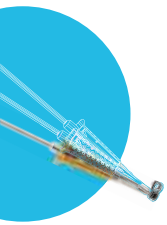

胸腔镜小切口器械
Thoracoscopic Small Incision Instruments



单孔型 分离结扎钳
Dissecting and ligature forceps

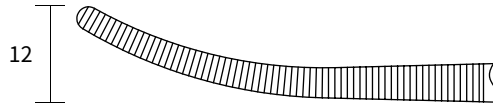

★ **ZP1582RB**
360×12, 滑板式, 弯,
小切口, 6mm杆径
Shaft 6mm

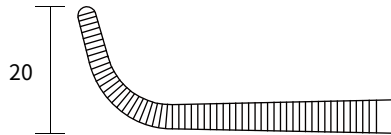

★ **ZP1583RB**
360×20, 滑板式,
角弯75°, 6mm杆径
Shaft 6mm

普通型 分离结扎钳
Dissecting and ligature forceps

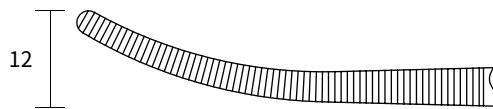

ZP1188RB
340×12, 滑板式, 弯,
小切口, 8mm杆径
Shaft 8mm

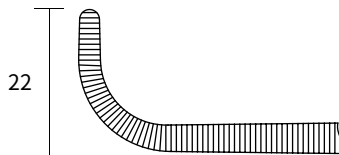

ZP1189RB
340×22×90°, 滑板式, 弯,
小切口, 8mm杆径
Shaft 8mm

单孔型 分离结扎钳
Dissecting and ligature forceps

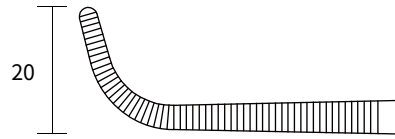

ZP1535RB
320×20, 滑板式, 角弯75°,
双开, 6mm杆径
Double action, shaft 6mm

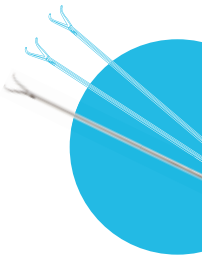

胸腔镜小切口器械
Thoracoscopic Small Incision Instruments

单孔型 海绵钳
Sponge forceps

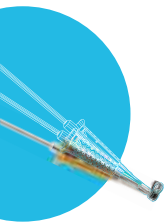

胸腔镜小切口器械
Thoracoscopic Small Incision Instruments



ZP1548RB

340×8, 滑板式, 弯有齿, 小切口, 5mm杆径 Shaft 5mm

ZP1549RB

340×10, 滑板式, 弯有齿, 小切口, 5mm杆径 Shaft 5mm

ZP1550RB

340×12, 滑板式, 弯有齿, 小切口, 5mm杆径 Shaft 5mm

★ **ZP1605RB**

360×8, 滑板式, 弯有齿, 小切口, 6mm杆径 Shaft 6mm

★ **ZP1606RB**

360×10, 滑板式, 弯有齿, 小切口, 6mm杆径 Shaft 6mm

★ **ZP1607RB**

360×12, 滑板式, 弯有齿, 小切口, 6mm杆径 Shaft 6mm

ZP1557RB

340×8, 滑板式, 弯无齿, 小切口, 5mm杆径 Shaft 5mm

ZP1558RB

340×10, 滑板式, 弯无齿, 小切口, 5mm杆径 Shaft 5mm

ZP1559RB

340×12, 滑板式, 弯无齿, 小切口, 5mm杆径 Shaft 5mm

★ **ZP1602RB**

360×8, 滑板式, 弯无齿, 小切口, 6mm杆径 Shaft 6mm

★ **ZP1603RB**

360×10, 滑板式, 弯无齿, 小切口, 6mm杆径 Shaft 6mm

★ **ZP1604RB**

360×12, 滑板式, 弯无齿, 小切口, 6mm杆径 Shaft 6mm

★ **ZP1587RB**

340×12, 滑板式, 弯无齿, 小切口, 6mm杆径 Shaft 6mm

★ **ZP1588RB**

340×12, 滑板式, 弯无齿, 小切口, 6mm杆径 Shaft 6mm

普通型 海绵钳
Sponge forceps

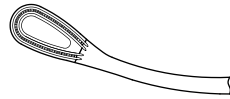

ZP1217RB

360×8, 滑板式, 弯, 小切口, 8mm杆径 Shaft 8mm

ZP1218RB

360×10, 滑板式, 弯, 小切口, 8mm杆径 Shaft 8mm

ZP1221RB

360×12, 滑板式, 弯, 小切口, 8mm杆径 Shaft 8mm



ZP1173RB

360×8, 滑板式, 弯有齿, 小切口, 8mm杆径 Shaft 8mm

ZP1172RB

360×10, 滑板式, 弯有齿, 小切口, 8mm杆径 Shaft 8mm

ZP1171RB

360×12, 滑板式, 弯有齿, 小切口, 8mm杆径 Shaft 8mm

ZP1560RB

420×10, 滑板式, 弯有齿, 小切口, 7mm杆径 Shaft 7mm



ZP1561RB

420×10, 滑板式, 弯无齿, 小切口, 7mm杆径 Shaft 7mm

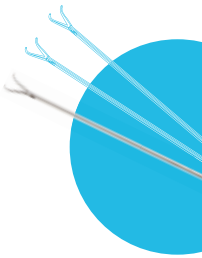

胸腔镜小切口器械
Thoracoscopic Small Incision Instruments

单孔型 海绵钳
Sponge forceps

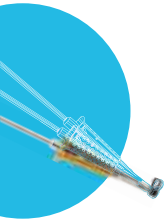

胸腔镜小切口器械
Thoracoscopic Small Incision Instruments

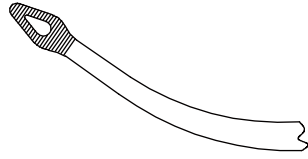

ZP1510RB

310×5, 滑板式, 弯有槽, 小切口, 5mm杆径
Shaft 5mm

★ **ZP1562RB**

340×5, 滑板式, 弯, 有槽, 小切口, 6mm杆径
Shaft 6mm

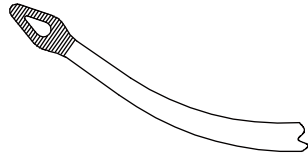

ZP1590RB

420×6, 滑板式, 弯, 有槽, 小切口, 6mm杆径
Shaft 6mm

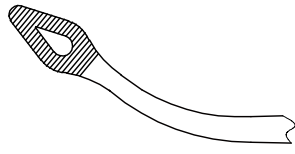

ZP1551RB

310×8, 滑板式, 弯, 有槽, 小切口, 5mm杆径
Shaft 5mm

★ **ZP1563RB**

340×8, 滑板式, 弯, 有槽, 小切口, 6mm杆径
Shaft 6mm

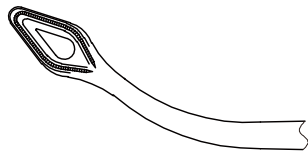

ZP1552RB

310×8, 滑板式, 弯, 有槽, 小切口, 5mm杆径
Shaft 5mm

ZP1553RB

310×10, 滑板式, 弯, 有槽, 小切口, 5mm杆径
Shaft 5mm

★ **ZP1565RB**

340×8, 滑板式, 弯, 有槽, 小切口, 6mm杆径
Shaft 6mm

★ **ZP1566RB**

340×10, 滑板式, 弯, 有槽, 小切口, 6mm杆径
Shaft 6mm

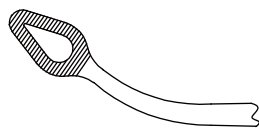

ZP1512RB

310×10, 滑板式, 弯有槽, 小切口, 5mm杆径
Shaft 5mm

★ **ZP1564RB**

340×10, 滑板式, 弯, 有槽, 小切口, 6mm杆径
Shaft 6mm

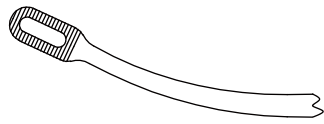

★ **ZP1514RB**

330×6, 滑板式, 弯有槽, 小切口, 5mm杆径
Shaft 5mm

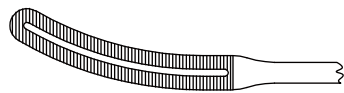

★ **ZP1516RB**

340×8, 滑板式, 弯有槽, 小切口, 5mm杆径
Shaft 5mm

普通型 海绵钳
Sponge forceps

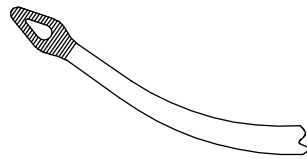

ZP1511RB
310×5, 滑板式, 弯有槽, 小切口, 7mm杆径
Shaft 7mm

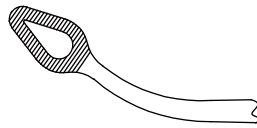

ZP1513RB
310×10, 滑板式, 弯有槽, 小切口, 7mm杆径
Shaft 7mm

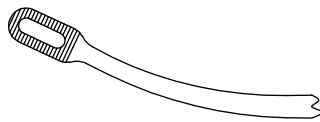

ZP1515RB
330×6, 滑板式, 弯有槽, 小切口, 7mm杆径
Shaft 7mm

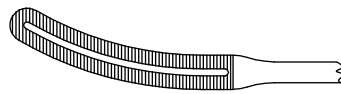

ZP1517RB
340×8, 滑板式, 弯有槽, 小切口, 7mm杆径
Shaft 7mm

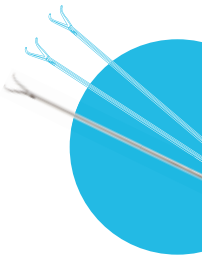

胸腔镜小切口器械
Thoracoscopic Small Incision Instruments

单孔型 海绵钳
Sponge forceps

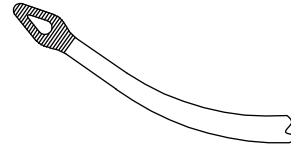

ZP1536RB
325×5, 滑板式, 弯, 有槽, 小切口双开,
蛇头型, 6mm杆径
Shaft 6mm, double action

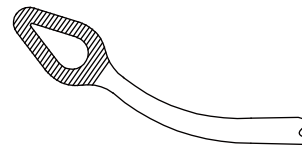

ZP1537RB
325×10, 滑板式, 弯, 有槽, 小切口双开,
蛇头型, 6mm杆径
Shaft 6mm, double action

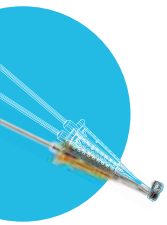

胸腔镜小切口器械
Thoracoscopic Small Incision Instruments

单孔型 小切口持针钳
Needle holder with TC 0.3 for thin needle



ZP1518RB
300, 滑板式, 直, 细针, 镶片0.3, 5mm杆径 Shaft 5mm

★ **ZP1573RB**
340, 滑板式, 直, 细针, 镶片0.3, 6mm杆径 Shaft 6mm

ZP1597RB
420, 滑板式, 直, 细针, 镶片0.3, 6mm杆径 Shaft 6mm

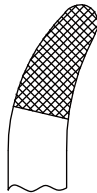

ZP1519RB
300, 滑板式, 弯, 细针, 镶片0.3, 5mm杆径 Shaft 5mm

★ **ZP1574RB**
340, 滑板式, 弯, 细针, 镶片0.3, 6mm杆径 Shaft 6mm

ZP1598RB
420, 滑板式, 弯, 细针, 镶片0.3, 6mm杆径 Shaft 6mm

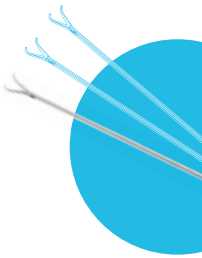

胸腔镜小切口器械
Thoracoscopic Small Incision Instruments

单孔型 精细剪
Delicate scissors

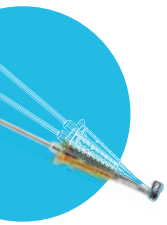

胸腔镜小切口器械
Thoracoscopic Small Incision Instruments

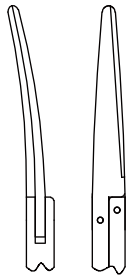

ZP1520RB
280×2, 滑板式, 弯, 窄头, 5mm杆径 Shaft 5mm

ZP1521RB
280×3, 滑板式, 弯, 宽头, 5mm杆径 Shaft 5mm

★ **ZP1575RB**
320×2, 滑板式, 弯, 窄头, 6mm杆径 Shaft 6mm

★ **ZP1576RB**
320×3, 滑板式, 弯, 宽头, 6mm杆径 Shaft 6mm

ZP1599RB
420×2, 滑板式, 弯, 窄头, 6mm杆径 Shaft 6mm

单孔型 夹持钳
Holding forceps
Shaft 5mm



★ **ZP1522RB**
340×2.5, 滑板式, 直头, 指圈式,
小切口, 5mm杆径

★ **ZP1524RB**
340×3.2, 滑板式, 直头, 指圈式,
小切口, 5mm杆径

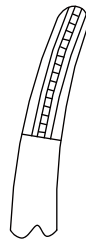

★ **ZP1523RB**
340×2.5, 滑板式, 弯头, 指圈式,
小切口, 5mm杆径

★ **ZP1525RB**
340×3.2, 滑板式, 弯头, 指圈式,
小切口, 5mm杆径

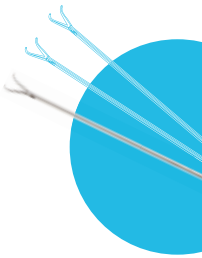

胸腔镜小切口器械
Thoracoscopic Small Incision Instruments

小切口肺叶钳
MIS lung grasping forceps

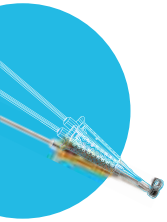

胸腔镜小切口器械
Thoracoscopic Small Incision Instruments



单孔型

- ★ **ZP1547RB**
340×12, 弯有齿, 滑板式, 肺叶, 5mm杆径
Shaft 5mm



单孔型

- ZP1586RB**
360×12, 弯有齿, 1×2齿, 滑板式,
肺叶, 5mm杆径
Shaft 5mm

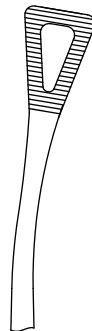

普通型

- ZP1186RB**
360×12, 弯有齿, 滑板式, 肺叶, 8mm杆径
Shaft 8mm

小切口组织钳
MIS tissue forceps



单孔型

★ **ZP1542RB**
340×8, 弯, 滑板式, 5mm杆径
Shaft 5mm



单孔型

ZP1543RB
340×8, 弯, 滑板式, 2×3齿, 5mm杆径
Shaft 5mm



普通型

ZP1182RB
360×6, 弯, 滑板式, 8mm杆径
Shaft 8mm

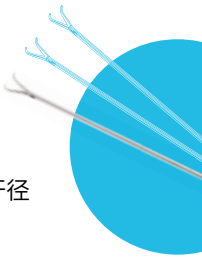

胸腔镜小切口器械
Thoracoscopic Small Incision Instruments

小切口淋巴钳
MIS
lymphatic
forceps

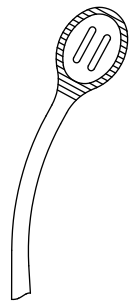

单孔型

- ★ **ZP1544RB**
340×8, 滑板式, 匙形, 淋巴, 5mm杆径 Shaft 5mm
- ★ **ZP1545RB**
340×10, 滑板式, 匙形, 淋巴, 5mm杆径 Shaft 5mm
- ★ **ZP1546RB**
340×12, 滑板式, 匙形, 淋巴, 5mm杆径 Shaft 5mm

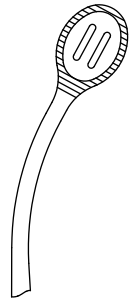

普通型

- ZP1178RB**
360×10, 滑板式, 匙形, 淋巴, 8mm杆径 Shaft 8mm
- ZP1179RB**
360×12, 滑板式, 匙形, 淋巴, 8mm杆径 Shaft 8mm

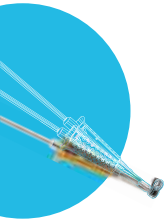

胸腔镜小切口器械
Thoracoscopic Small Incision Instruments

单孔型 器械钳

Instrument forceps

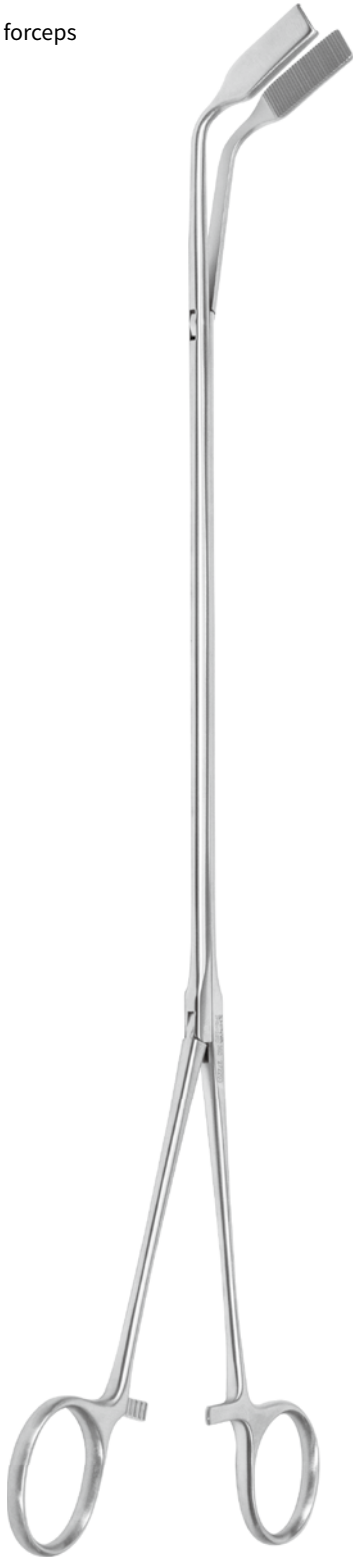

ZP1584RB
360, 弯有槽, 6mm杆径
适配反力式止血夹
Shaft 6mm

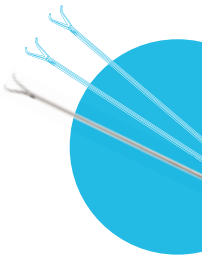

胸腔镜小切口器械
Thoracoscopic Small Incision Instruments

血管钳
Vascular clamp

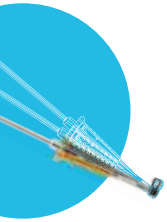

胸腔镜小切口器械
Thoracoscopic Small Incision Instruments



ZL1101RN
320, 钳式, 直, 小切口

ZL1102RN
320, 钳式, 直, 无锁止牙, 小切口
Without ratchet

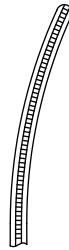

ZL1104RN
320×154×15, 钳式, 弯, 小切口

ZL1109RN
320×154×15, 钳式, 弯, 无锁止牙, 小切口
Without ratchet

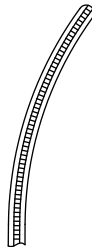

ZL1105RN
320×151×20, 钳式, 弯, 小切口

ZL1110RN
320×151×20, 钳式, 弯, 无锁止牙, 小切口
Without ratchet

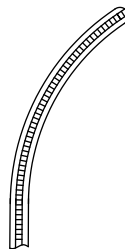

ZL1106RN
320×148×25, 钳式, 弯, 小切口

ZL1111RN
320×148×25, 钳式, 弯, 无锁止牙, 小切口
Without ratchet

血管钳
Vascular clamp

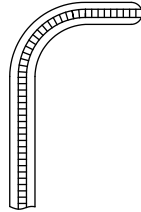

ZL1114RN
320×22×90°, 钳式, 弯, 小切口

ZL1119RN
320×22×90°, 钳式, 弯, 无锁止牙, 小切口
Without ratchet

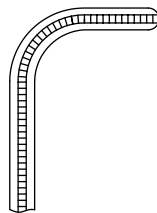

ZL1115RN
320×25×90°, 钳式, 弯, 小切口

ZL1120RN
320×25×90°, 钳式, 弯, 无锁止牙, 小切口
Without ratchet

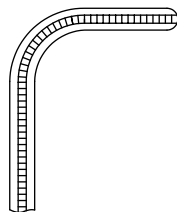

ZL1116RN
320×28×90°, 钳式, 弯, 小切口

ZL1121RN
320×28×90°, 钳式, 弯, 无锁止牙, 小切口
Without ratchet

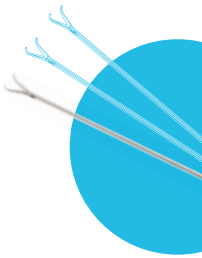

胸腔镜小切口器械
Thoracoscopic Small Incision Instruments

分离结扎钳
Dissecting and
ligature forceps

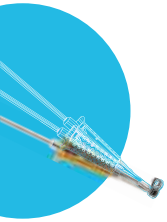

胸腔镜小切口器械
Thoracoscopic Small Incision Instruments



ZH457RN
320×155×8, 钳式, 弯, 小切口

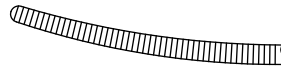

ZH458RN
320×150×12, 钳式, 弯, 小切口

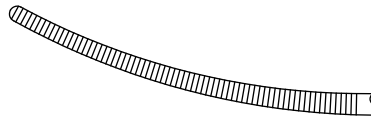

ZH461RN
320×150×22, 钳式, 弯, 小切口

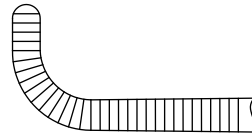

ZH463RN
320×15×90°, 钳式, 弯, 小切口

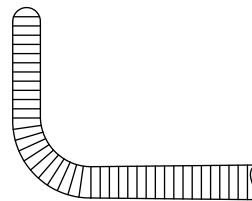

ZH466RN
320×22×90°, 钳式, 弯, 小切口

海绵钳
Sponge forceps

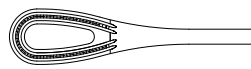
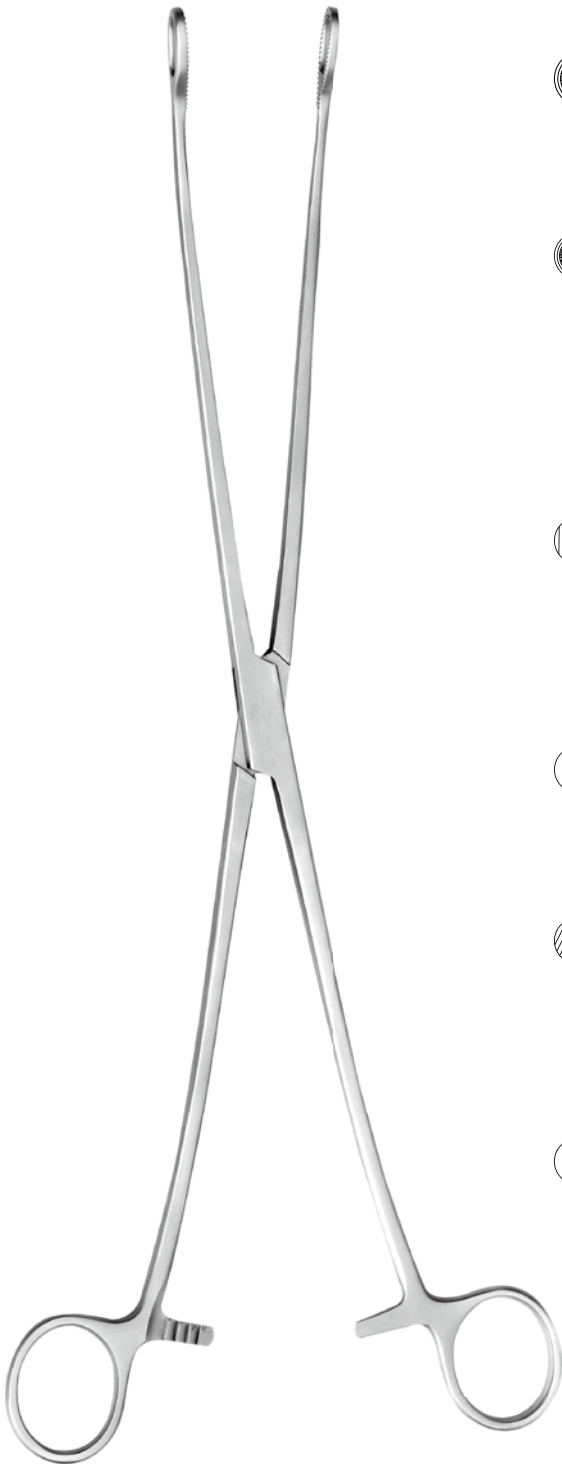

- ZE171RN** 320×8, 钳式, 直, 小切口
- ZE172RN** 320×10, 钳式, 直, 小切口
- ZE173RN** 320×12, 钳式, 直, 小切口

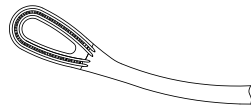

- ZE174RN** 320×8, 钳式, 弯, 小切口
- ZE175RN** 320×10, 钳式, 弯, 小切口
- ZE176RN** 320×12, 钳式, 弯, 小切口

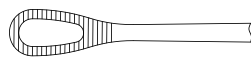

- ZE177RN** 320×8, 钳式, 直有齿, 小切口
- ZE178RN** 320×10, 钳式, 直有齿, 小切口
- ZE179RN** 320×12, 钳式, 直有齿, 小切口



- ZE180RN** 320×8, 钳式, 直无齿, 小切口
- ZE181RN** 320×10, 钳式, 直无齿, 小切口
- ZE182RN** 320×12, 钳式, 直无齿, 小切口

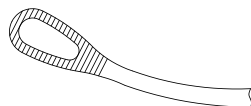

- ZE183RN** 320×8, 钳式, 弯有齿, 小切口
- ZE184RN** 320×10, 钳式, 弯有齿, 小切口
- ZE185RN** 320×12, 钳式, 弯有齿, 小切口

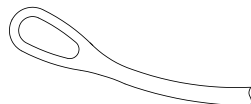

- ZE186RN** 320×8, 钳式, 弯无齿, 小切口
- ZE187RN** 320×10, 钳式, 弯无齿, 小切口
- ZE188RN** 320×12, 钳式, 弯无齿, 小切口

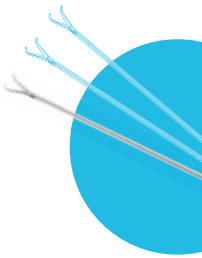

胸腔镜小切口器械
Thoracoscopic Small Incision Instruments

海绵钳
 Sponge forceps

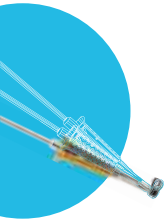

胸腔镜小切口器械
 Thoracoscopic Small Incision Instruments

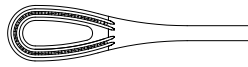

- ZE231RN** 320×8, 钳式, 直, 短杆, 小切口
- ZE232RN** 320×10, 钳式, 直, 短杆, 小切口
- ZE233RN** 320×12, 钳式, 直, 短杆, 小切口

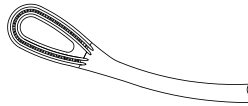

- ZE234RN** 320×8, 钳式, 弯, 短杆, 小切口
- ZE235RN** 320×10, 钳式, 弯, 短杆, 小切口
- ZE236RN** 320×12, 钳式, 弯, 短杆, 小切口

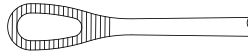

- ZE237RN** 320×8, 钳式, 直有齿, 短杆, 小切口
- ZE238RN** 320×10, 钳式, 直有齿, 短杆, 小切口
- ZE239RN** 320×12, 钳式, 直有齿, 短杆, 小切口



- ZE240RN** 320×8, 钳式, 直无齿, 短杆, 小切口
- ZE241RN** 320×10, 钳式, 直无齿, 短杆, 小切口
- ZE242RN** 320×12, 钳式, 直无齿, 短杆, 小切口

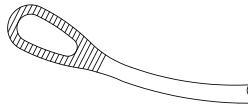

- ZE243RN** 320×8, 钳式, 弯有齿, 短杆, 小切口
- ZE244RN** 320×10, 钳式, 弯有齿, 短杆, 小切口
- ZE245RN** 320×12, 钳式, 弯有齿, 短杆, 小切口

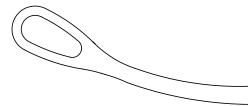

- ZE246RN** 320×8, 钳式, 弯无齿, 短杆, 小切口
- ZE247RN** 320×10, 钳式, 弯无齿, 短杆, 小切口
- ZE248RN** 320×12, 钳式, 弯无齿, 短杆, 小切口

精细剪
Delicate scissors



ZC868RN
320, 钳式, 单关节, 弯, 窄头, 小切口
With narrow tip

ZC869RN
320, 钳式, 单关节, 弯, 宽头, 小切口
With broad tip

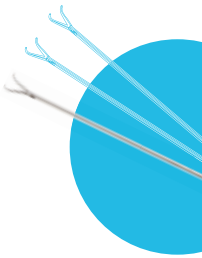

胸腔镜小切口器械
Thoracoscopic Small Incision Instruments

精细剪
Delicate scissors



ZP1286RN

320, 钳式, 双关节, 弯, 窄头, 小切口
With narrow tip

ZP1289RN

320, 钳式, 双关节, 弯, 宽头, 小切口
With broad tip

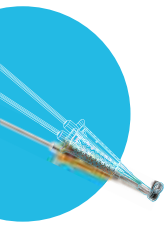

胸腔镜小切口器械
Thoracoscopic Small Incision Instruments

小切口组织钳
MIS tissue forceps

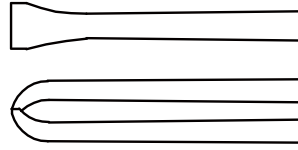

ZE193RN

320×6, 钳式, 直

ZE194RN

320×9, 钳式, 直

ZE196RN

320×15, 钳式, 直

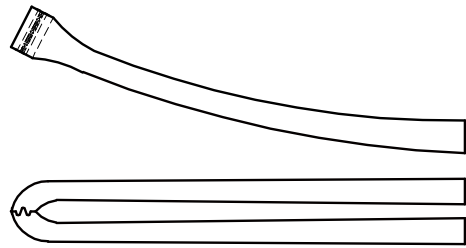

ZE199RN

320×6, 钳式, 弯, 无损伤1×2 齿

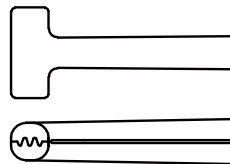

ZE201RN

320×12, 钳式,
T形, 无损伤2×3 齿

ZE202RN

320×16, 钳式,
T形, 无损伤2×3 齿



ZE210RN

320×8, 钳式, 匙形, 淋巴

ZE211RN

320×11, 钳式, 匙形, 淋巴

ZE212RN

320×14, 钳式, 匙形, 淋巴

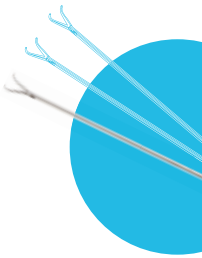

胸腔镜小切口器械
Thoracoscopic Small Incision Instruments

显微钩
Micro hook

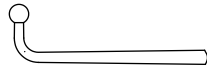

ZP1349RN
360×4.5, 直型, 球头, 小切口



ZP1350RN
360×5, 直型, 钝头, 小切口



ZP1351RN
360×9, 直型, 钝头, 小切口



★ **ZP1352RB**
340×5, 小切口

★ **ZP1353RB**
340×9, 小切口

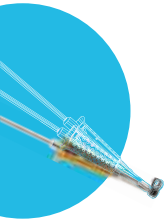

胸腔镜小切口器械
Thoracoscopic Small Incision Instruments



小切口手术缝合线拉钩
Small incision suture hook

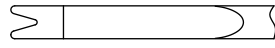

ZP1311RN
240×Φ5

ZP1313RN
280×Φ5



★ **ZP1314RN**
380×Φ5

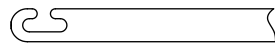

ZP1317RN
380×Φ5

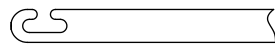

ZP1377RN
250×Φ2.5直, 环形圆头

ZP1380RN
370×Φ2.5直, 环形圆头



ZP1383RN
370×Φ1.5直, 镰状尖头

ZP1384RN
370×Φ2.0直, 镰状尖头

ZP1385RN
370×Φ2.5直, 镰状尖头



ZP1539RB
330, 回型



ZP1540RB
330, U型, 左向 Left

ZP1541RB
330, U型, 右向 Right

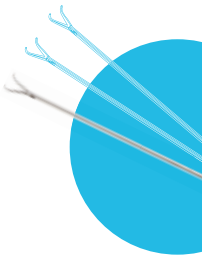

胸腔镜小切口器械
Thoracoscopic Small Incision Instruments

手术刀柄/吸引管
Scalpel handle/suction tube

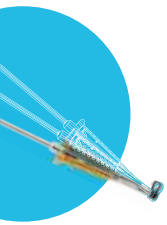

胸腔镜小切口器械
Thoracoscopic Small Incision Instruments



ZP1354RB
340
适配9#-17#手术刀片
for 9#-17# blades



★ **ZP1538RB**
380, 双弯, 小切口



吸引管
Suction tube



★ **ZP1577RB**
380, 弯, 小切口



ZP1332RN
360×Φ6, 弯形平头, 小切口

ZP1339RN
450×Φ6, 弯形平头, 小切口



ZP1333RN
360×Φ6, 角弯平头, 小切口

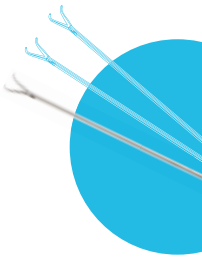

胸腔镜小切口器械
Thoracoscopic Small Incision Instruments

吸引管
Suction tube

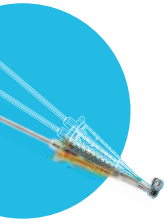

胸腔镜小切口器械
Thoracoscopic Small Incision Instruments



ZP1334RN
360×Φ6, 角弯喇叭头,
小切口



ZP1340RN
450×Φ6,
弯形喇叭头,
小切口



ZP1578RB
450×Φ6,
弯形喇叭头,
小切口, 磨砂面
With frosted surface



★ **ZP1589RB**
385×Φ5, 弯,
小切口

外科牵开器
Surgical retractor

ZL844RN

双叶, 固定式, 30×40, 小切口

ZL845RN

双叶, 固定式, 30×60, 小切口

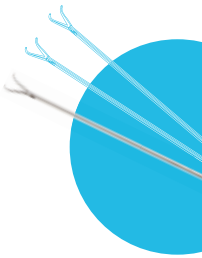
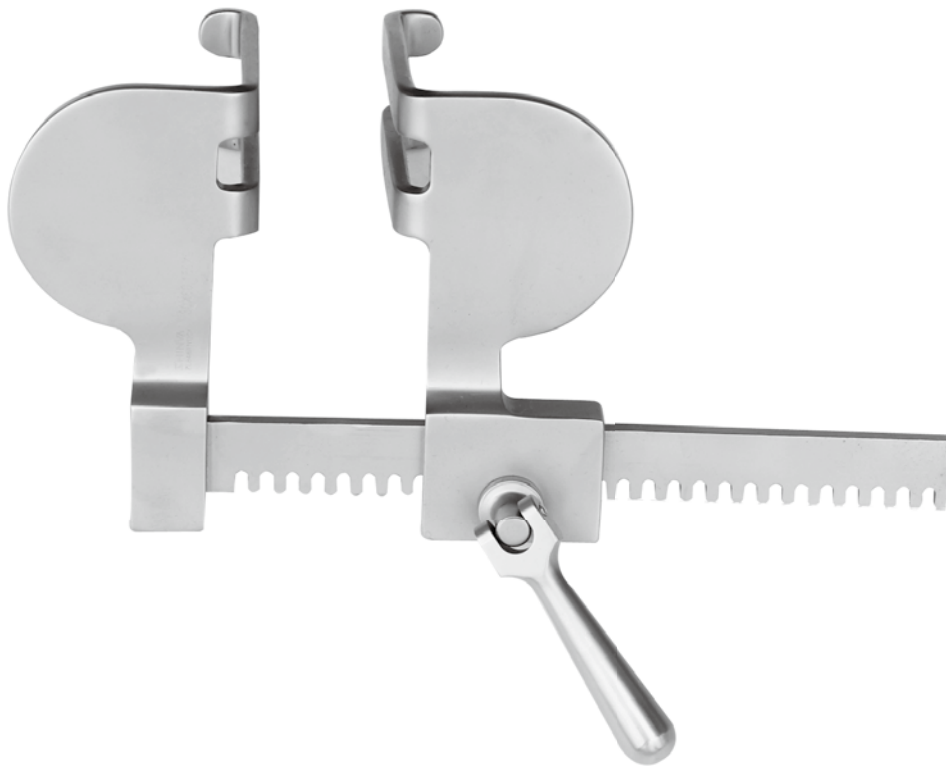

胸腔镜小切口器械
Thoracoscopic Small Incision Instruments

外科牵开器
Surgical retractor

ZL846RN

单叶, 固定式, 36×45 附拉钩, 小切口

ZL847RN

单叶, 固定式, 36×60 附拉钩, 小切口

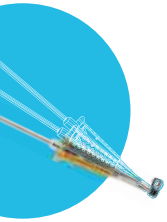

胸腔镜小切口器械
Thoracoscopic Small Incision Instruments

外科牵开器
Surgical retractor

ZL848RN

单叶, 固定式, 30×46 附拉钩, 小切口

ZL849RN

单叶, 固定式, 30×66 附拉钩, 小切口

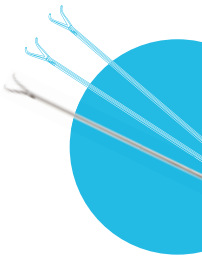

胸腔镜小切口器械
Thoracoscopic Small Incision Instruments

外科牵开器
Surgical retractor

ZL993RN
组合式, 小切口

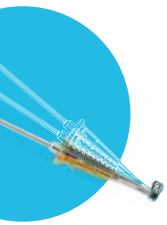
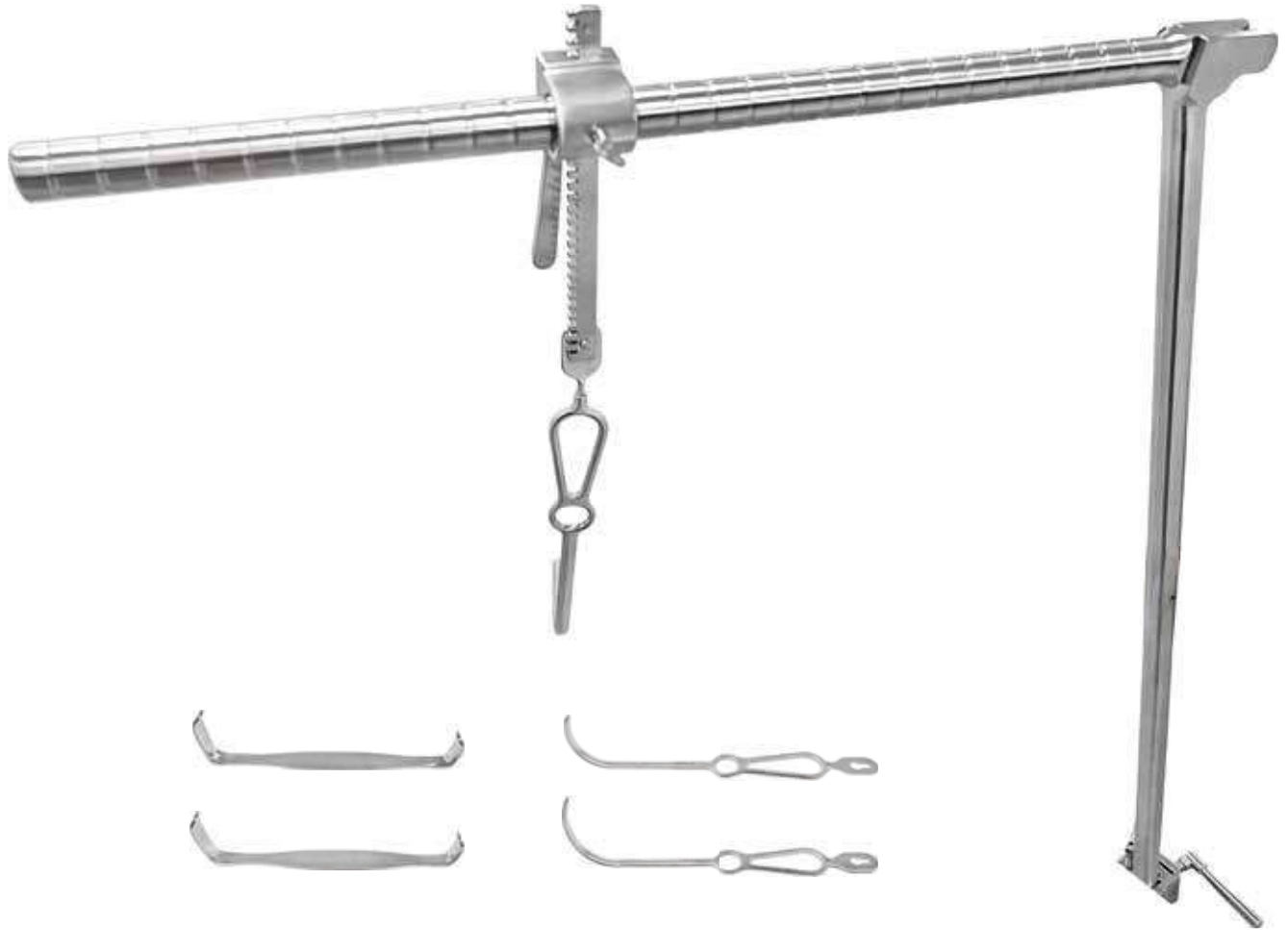

胸腔镜小切口器械
Thoracoscopic Small Incision Instruments

外科牵开器
Surgical retractor

ZL869RG
单叶, 拆卸式, 附叶片, 附拉钩, 小切口

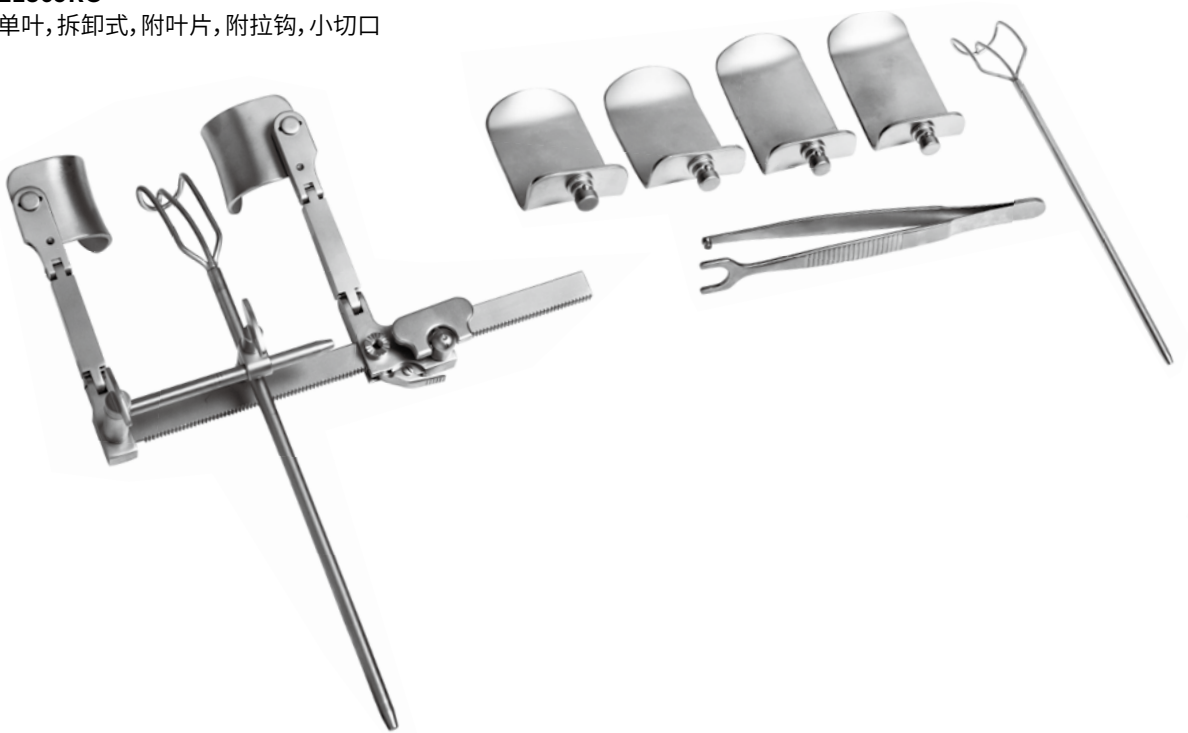

ZL991RN
130×110, 单叶, 小切口

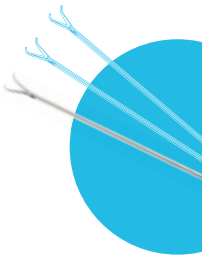

胸腔镜小切口器械
Thoracoscopic Small Incision Instruments

成套器械包
Surgical Instrument Set

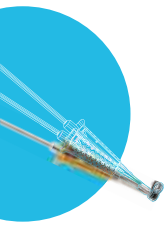

胸腔镜小切口器械
Thoracoscopic Small Incision Instruments

XQ- I 型胸腔外科手术器械包 (微创搭桥包) (ZL181)
XQ- I type MIS Heart Bypass Instruments set

序号	编 码	名 称	规 格	单 位	数 量
1	JP1643RB	小切口持针钳	250,直,单开,镶片,握笔管式	把	1
2	JP1646RB	小切口持针钳	250,弯,单开,镶片,握笔管式	把	1
3	JP1703RB	夹持钳	250,握笔管式	把	1
4	JP1706RB	夹持钳	250,握笔管式	把	1
5	JP1691RB	夹持钳	250,上翘45°,单开,握笔管式	把	1
6	JP1667RB	夹持钳	250X1.5, 1X2凹凸齿,直头,双开握笔管式	把	1
7	JP1685RB	夹持钳	250X 1.5, 1X 2凹凸齿,角弯,单开,握笔管式	把	1
8	JP1622RB	精细剪	250,弯45°,单开,握笔管式	把	1
9	JP1628RB	精细剪	250,弯125°,单开,握笔管式	把	1
10	ZL869RG	外科牵开器	单叶,拆卸式,附叶片,附拉钩,小切口	把	1



XQ-II型胸腔外科手术器械包(微创瓣膜包) (ZL182)

XQ-II type MIS Valve Replacement Instruments Set

序号	编码	名称	规格	单位	数量
1	JP1610RB	精细剪	250,弯,双开,握笔管式	把	1
2	JP1613RB	精细剪	250,弯,双开,握笔管式	把	1
3	JP1643RB	小切口持针钳	250,直,单开,镶片,握笔管式	把	1
4	JP1646RB	小切口持针钳	250,弯,单开,镶片,握笔管式	把	1
5	JP1673RB	夹持钳	250X2.8,1X 2凹凸齿,直头,双开,握笔管式	把	1
6	JP1676RB	夹持钳	250X3,直头,单开,握笔管式	把	1
7	JP1691RB	夹持钳	250,上翘45°,单开,握笔管式	把	1
8	ZL869RG	外科牵开器	单叶,拆卸式,附叶片,附拉钩,小切口	把	1
9	ZP1352RB	显微钩	340X5,小切口	把	1
10	ZP1353RB	显微钩	340X9,小切口	把	1
11	ZP1354RB	手术刀柄	340	把	1
12	ZF1756RB	髓核钳	300X 3,指圈式	把	1
13	ZL1130RB	血管钳	135,直	把	1
14	ZL1131RB	血管钳	120,直	把	1
15	ZL1132RB	血管钳	110,直	把	1
16	ZL1133RB	血管钳	130,弯	把	1
17	ZL1134RB	血管钳	120,弯	把	1
18	ZL1135RB	血管钳	110,弯	把	1
19	ZL1136RB	起子	350	把	1
20	ZL1137RB	夹持钳	250	把	1

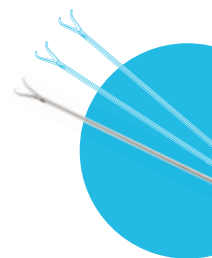

胸腔镜小切口器械
Thoracoscopic Small Incision Instruments

成套器械包
Surgical Instrument Set

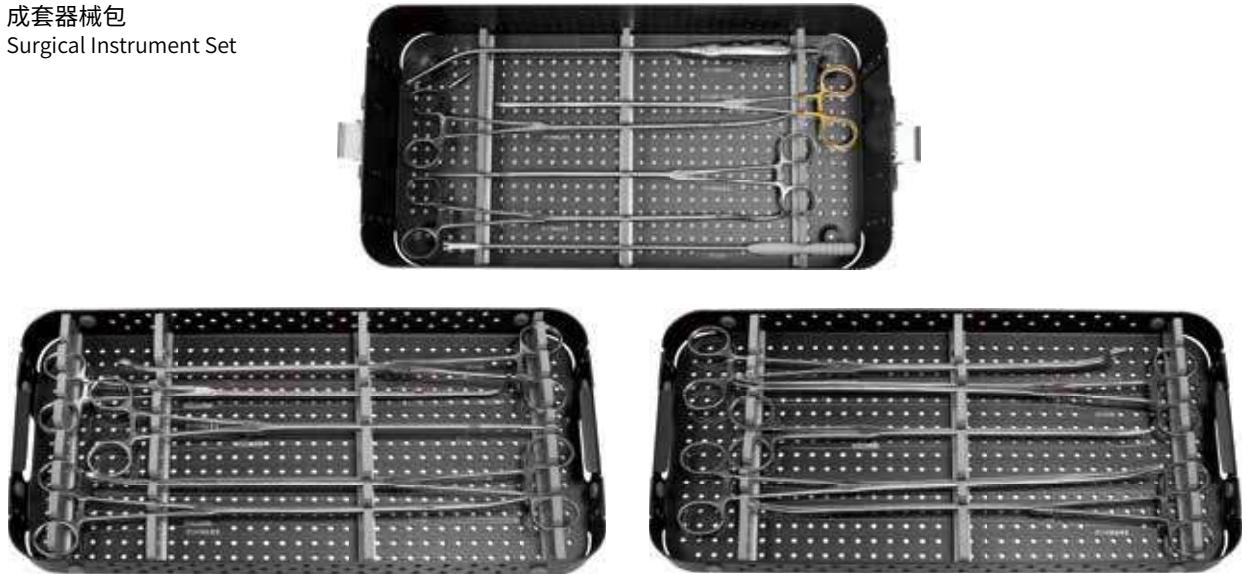

I 型 微创小切口双关节器械包 (ZP1579)
I type MIS Incision Double Joint Instrument Set

序号	编 码	名 称	规 格	单位	数量
1	ZP1567RB	血管钳	360×15, 滑板式, 圆弯, 1×2齿	把	1
2	ZP1568RB	血管钳	360×20, 滑板式, 圆弯, 1×2齿	把	1
3	ZP1569RB	血管钳	360×25, 滑板式, 圆弯, 1×2齿	把	1
4	ZP1570RB	血管钳	360×25×90°, 滑板式, 弯, 1×2齿	把	1
5	ZP1571RB	血管钳	360×18×90°, 滑板式, 弯, 1×2齿	把	1
6	ZP1572RB	血管钳	360×75×30, 滑板式, 圆弯, 1×2齿	把	1
7	ZP1562RB	海绵钳	340×5, 滑板式, 弯, 有槽, 小切口	把	1
8	ZP1564RB	海绵钳	340×10, 滑板式, 弯, 有槽, 小切口	把	1
9	ZP1172RB	海绵钳	360×10, 滑板式, 弯有齿, 小切口	把	1
10	ZP1173RB	海绵钳	360×8, 滑板式, 弯有齿, 小切口	把	1
11	ZP1574RB	小切口持针钳	340, 滑板式, 弯, 细针, 镶片0.3	把	1
12	ZP1575RB	精细剪	320×2, 滑板式, 弯, 窄头	把	1
13	ZP1182RB	小切口组织钳	360×6, 弯, 滑板式	把	1
14	ZP1545RB	小切口组织钳	340×10, 滑板式, 匙形, 淋巴	把	1
15	ZP1314RN	小切口手术缝合线拉钩	380×Φ5	把	1
16	ZP1577RB	吸引管	380, 弯, 小切口	把	1



II 型 微创小切口双关节器械包 (ZP1608) II type MIS Incision Double Joint Instrument Set

序号	编码	名称	规格	单位	数量
1	ZP1314RN	小切口手术缝合线拉钩	380×Φ5	把	1
2	ZP1560RB	海绵钳	420×10, 滑板式, 弯有齿, 小切口	把	1
3	ZP1561RB	海绵钳	420×10, 滑板式, 弯无齿, 小切口	把	1
4	ZP1589RB	吸引管	385×Φ5, 弯, 小切口	把	1
5	ZP1590RB	海绵钳	420×6, 滑板式, 弯, 有槽, 小切口	把	1
6	ZP1591RB	血管钳	420×20×90°, 滑板式, 弯, 1×2齿	把	1
7	ZP1592RB	血管钳	420×10, 滑板式, 圆弯, 1×2齿	把	1
8	ZP1593RB	血管钳	420×15, 滑板式, 圆弯, 1×2齿	把	1
9	ZP1594RB	血管钳	420×20, 滑板式, 圆弯, 1×2齿	把	1
10	ZP1595RB	血管钳	420×25, 滑板式, 圆弯, 1×2齿	把	1
11	ZP1596RB	血管钳	420×25×90°, 滑板式, 弯, 1×2齿	把	1
12	ZP1597RB	小切口持针钳	420, 滑板式, 直, 细针, 镶片0.3	把	1
13	ZP1598RB	小切口持针钳	420, 滑板式, 弯, 细针, 镶片0.3	把	1
14	ZP1599RB	精细剪	420×2, 滑板式, 弯, 窄头	把	1
15	ZP1600RB	血管钳	420×75×30, 滑板式, 圆弯, 1×2齿	把	1

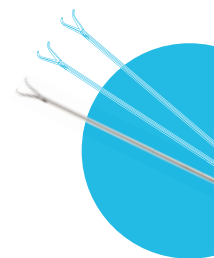

胸腔镜小切口器械
Thoracoscopic Small Incision Instruments

成套器械包
Surgical Instrument Set

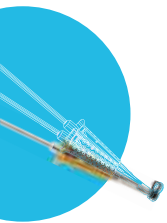

III型 微创小切口双关节器械包 (ZP1609)
III type MIS Incision Double Joint Instrument Set

胸腔镜小切口器械
Thoracoscopic Small Incision Instruments

序号	编 码	名 称	规 格	单位	数量
1	ZP1567RB	血管钳	360×15, 滑板式, 圆弯, 1×2齿	把	1
2	ZP1568RB	血管钳	360×20, 滑板式, 圆弯, 1×2齿	把	1
3	ZP1569RB	血管钳	360×25, 滑板式, 圆弯, 1×2齿	把	1
4	ZP1570RB	血管钳	360×25×90°, 滑板式, 弯, 1×2齿	把	1
5	ZP1562RB	海绵钳	340×5, 滑板式, 弯, 有槽, 小切口	把	1
6	ZP1605RB	海绵钳	360×8, 滑板式, 弯有齿, 小切口	把	1
7	ZP1606RB	海绵钳	360×10, 滑板式, 弯有齿, 小切口	把	1
8	ZP1573RB	小切口持针钳	340, 滑板式, 直, 细针, 镶片0.3	把	1
9	ZP1575RB	精细剪	320×2, 滑板式, 弯, 窄头	把	1
10	ZP1544RB	小切口组织钳	340×8, 滑板式, 匙形, 淋巴	把	1
11	ZP1314RN	小切口手术缝合线拉钩	380×φ5	把	1
12	ZP1589RB	吸引管	385×φ5, 弯, 小切口	把	1



IV型 微创小切口双关节器械包 (ZP1610)
IV type MIS Incision Double Joint Instrument Set

序号	编码	名称	规格	单位	数量
1	ZP1567RB	血管钳	360×15, 滑板式, 圆弯, 1×2齿	把	1
2	ZP1568RB	血管钳	360×20, 滑板式, 圆弯, 1×2齿	把	1
3	ZP1569RB	血管钳	360×25, 滑板式, 圆弯, 1×2齿	把	1
4	ZP1570RB	血管钳	360×25×90°, 滑板式, 弯, 1×2齿	把	1
5	ZP1581RB	血管钳	360×15×110°, 滑板式, 弯, 1×2齿	把	1
6	ZP1562RB	海绵钳	340×5, 滑板式, 弯, 有槽, 小切口	把	1
7	ZP1563RB	海绵钳	340×8, 滑板式, 弯, 有槽, 小切口	把	1
8	ZP1605RB	海绵钳	360×8, 滑板式, 弯有齿, 小切口	把	1
9	ZP1606RB	海绵钳	360×10, 滑板式, 弯有齿, 小切口	把	1
10	ZP1602RB	海绵钳	360×8, 滑板式, 弯无齿, 小切口	把	1
11	ZP1603RB	海绵钳	360×10, 滑板式, 弯无齿, 小切口	把	1
12	ZP1607RB	海绵钳	360×12, 滑板式, 弯有齿, 小切口	把	1
13	ZP1573RB	小切口持针钳	340, 滑板式, 直, 细针, 镶片0.3	把	1
14	ZP1575RB	精细剪	320×2, 滑板式, 弯, 窄头	把	1
15	ZP1544RB	小切口组织钳	340×8, 滑板式, 匙形, 淋巴	把	1
16	ZP1314RN	小切口手术缝合线拉钩	380×Φ5	把	1
17	ZP1589RB	吸引管	385×Φ5, 弯, 小切口	把	1

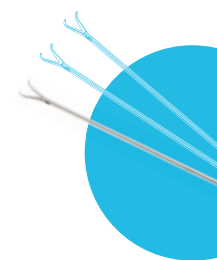

胸腔镜小切口器械
Thoracoscopic Small Incision Instruments

