

Orthopaedic Instruments  
矫形外科(骨科)

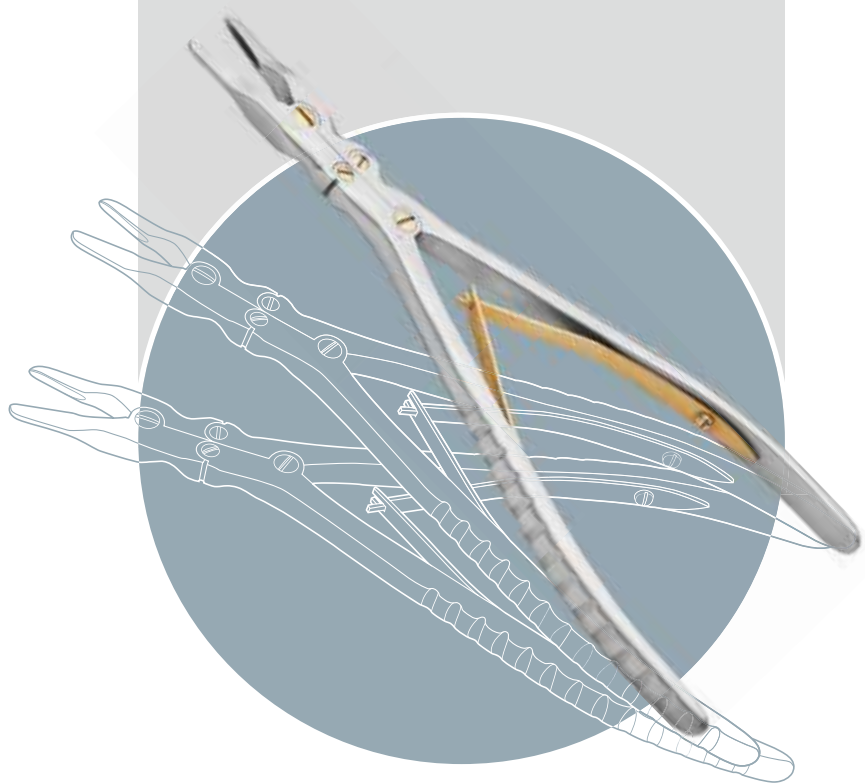

QUALITY  
OUR WAY TO SUCCESS

Orthopaedic Instruments

骨凿 (方柄)  
Chisel



- ★ZQ320R 140x2, 直, 双斜刃
- ★ZQ321R 140x4, 直, 双斜刃
- ★ZQ322R 140x6, 直, 双斜刃
- ★ZQ323R 140x8, 直, 双斜刃

- ★ZQ324R 140x10, 直, 双斜刃
- ZQ325R 140x2, 直, 单斜刃
- ZQ326R 140x4, 直, 单斜刃

- ZQ327R 140x6, 直, 单斜刃
- ZQ328R 140x8, 直, 单斜刃
- ZQ329R 140x10, 直, 单斜刃

骨凿 (扁柄)  
Chisel



- ZQ330R 140x2, 直, 双斜刃
- ZQ331R 140x4, 直, 双斜刃

- ZQ332R 140x6, 直, 双斜刃
- ZQ333R 140x8, 直, 双斜刃

- ZQ334R 140x10, 直, 双斜刃

骨凿 (方柄)  
Chisel



- ★ZQ335R 170x4, 直, 双斜刃
- ★ZQ336R 170x6, 直, 双斜刃
- ★ZQ337R 170x8, 直, 双斜刃
- ★ZQ338R 170x10, 直, 双斜刃

- ★ZQ339R 170x12, 直, 双斜刃
- ★ZQ340R 170x14, 直, 双斜刃
- ZQ341R 170x4, 直, 单斜刃
- ZQ342R 170x6, 直, 单斜刃

- ★ZQ343R 170x8, 直, 单斜刃
- ★ZQ344R 170x10, 直, 单斜刃
- ZQ345R 170x12, 直, 单斜刃
- ★ZQ346R 170x14, 直, 单斜刃

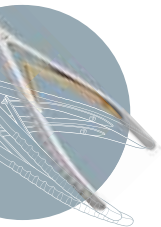

矫形外科 (骨科)  
Orthopaedic Instruments

单斜刃



超薄双斜刃



普通双斜刃



超薄圆刃



普通圆刃



圆骨凿 (方柄)  
Gouge



★ZQ347R 170x4, 直, 单斜刃

★ZQ348R 170x6, 直, 单斜刃

★ZQ349R 170x8, 直, 单斜刃

★ZQ350R 170x10, 直, 单斜刃

★ZQ351R 170x12, 直, 单斜刃

★ZQ352R 170x14, 直, 单斜刃

截骨刀 (长方柄)  
Chisel



★ZQ420R 230x6, 直, 双斜刃

★ZQ421R 230x9, 直, 双斜刃

★ZQ422R 230x12, 直, 双斜刃

★ZQ423R 230x16, 直, 双斜刃

ZQ424R 230x20, 直, 双斜刃

ZQ425R 230x25, 直, 双斜刃

ZQ426R 230x30, 直, 双斜刃

ZQ427R 230x36, 直, 双斜刃

截骨刀 (长方柄)  
Chisel, curved



ZQ428R 230x6, 弯, 双斜刃

ZQ429R 230x9, 弯, 双斜刃

ZQ430R 230x12, 弯, 双斜刃

ZQ431R 230x16, 弯, 双斜刃

ZQ432R 230x20, 弯, 双斜刃

ZQ433R 230x25, 弯, 双斜刃

ZQ434R 230x30, 弯, 双斜刃

ZQ435R 230x36, 弯, 双斜刃

骨刀  
Chisel



★ZK090R 170x3, 滚花柄

★ZK093R 170x5, 滚花柄

★ZK094R 170x7, 滚花柄

★ZK095R 170x10, 滚花柄

ZK114R 125x4, 直形, 圆柄

ZK115R 125x6, 直形, 圆柄

ZK116R 125x8, 直形, 圆柄

ZK117R 170x12, 直形, 圆柄

ZK118R 170x15, 直形, 圆柄

ZK119R 170x20, 直形, 圆柄

骨凿  
Chisel



★ZK091R 170x3, 滚花柄, 半圆型

★ZK092R 170x5, 滚花柄, 半圆型

薄型骨刀  
Chisel



★ZQ790R 180x2(手指用), 直, 双斜刃

★ZQ791R 180x3(手指用), 直, 双斜刃

★ZQ792R 180x4(手指用), 直, 双斜刃

★ZQ793R 180x5(手指用), 直, 双斜刃

★ZQ794R 180x6(手指用), 直, 双斜刃

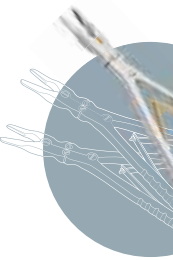

矫形外科(骨科)  
Orthopaedic Instruments

薄型骨刀  
Chisel



- ★ZQ775R 200x3(颈椎用),直,双斜刃
- ★ZQ776R 200x4(颈椎用),直,双斜刃
- ★ZQ777R 200x5(颈椎用),直,双斜刃
- ★ZQ778R 200x6(颈椎用),直,双斜刃
- ★ZQ779R 200x8(颈椎用),直,双斜刃
- ZQ780R 200x10(颈椎用),直,双斜刃

薄型骨刀  
Chisel



- ZQ775RN 200x3(颈椎用),直,双斜刃
- ZQ776RN 200x4(颈椎用),直,双斜刃
- ZQ777RN 200x5(颈椎用),直,双斜刃
- ZQ779RN 200x8(颈椎用),直,双斜刃

薄型骨刀  
Chisel



- ★ZQ1216RN 300x10

颈椎骨刀 (滚花柄)  
Chisel for cervical vertebra



- ★ZQ436R 220x6,直,双斜刃
- ★ZQ437R 220x9,直,双斜刃
- ★ZQ438R 220x12,直,双斜刃

骨刀  
Chisel



- ZQ392R 230x8,直,双刃
- ZQ393R 260x8,双刃

圆骨凿 (滚花柄)  
Gouge



- ★ZQ381R 220x4,直,单斜刃
- ★ZQ383R 220x6,直,单斜刃
- ★ZQ385R 220x8,直,单斜刃
- ★ZQ387R 220x10,直,单斜刃
- ★ZQ389R 220x12,直,单斜刃
- ZQ395R 180x4,直,圆刃

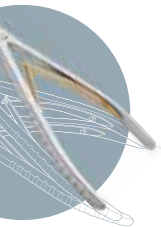

圆骨凿 (滚花柄)  
Gouge



**ZQ382R** 220x4, 弯, 单斜刀  
**ZQ384R** 220x6, 弯, 单斜刀

**ZQ386R** 220x8, 弯, 单斜刀  
**ZQ388R** 220x10, 弯, 单斜刀

**ZQ390R** 220x12, 弯, 单斜刀

弧形骨凿 (滚花柄)  
Osteotome



★**ZQ354R** 220 1#, 弯, 单斜刀

弧形骨凿 (滚花柄)  
Osteotome



**ZQ355R** 220 2#, 弯, 单斜刀

弧形骨凿 (滚花柄)  
Osteotome



★**ZQ356R** 220 3#, 弯, 单斜刀

骨凿 (滚花柄)  
Chisel



★**ZQ396R** 230x4, 直, 双斜刀  
★**ZQ397R** 230x6, 直, 双斜刀

★**ZQ358R** 230x8, 直, 双斜刀  
★**ZQ359R** 230x10, 直, 双斜刀

★**ZQ659R** 230x12, 直, 双斜刀

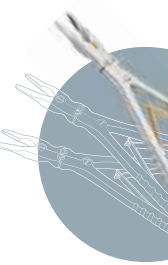

矫形外科(骨科)  
Orthopaedic Instruments

骨凿 (滚花柄)  
Chisel



★ ZQ357R 280x6, 直, 单斜刀

★ ZQ625R 280x8, 直, 单斜刀

ZQ626R 280x10, 直, 单斜刀

骨凿 (滚花柄)  
Chisel



★ ZQ363R 280x25° x10, 弯, 双斜刀

ZQ364R 280x25° x15, 弯, 双斜刀

圆骨凿 (滚花柄)  
Gouge



ZQ365R 280x25°x10, 弯, 圆刃

ZQ366R 280x25°x15, 弯, 圆刃

骨凿 (滚花柄)  
Chisel



ZQ367R 280x8, 梯形, 单斜刀

骨凿 (滚花柄)  
Chisel



ZQ368R 280x7, 直角, 单斜刀

圆骨凿 (滚花柄)  
Gouge



ZQ369R 340x10, 直, 圆刃

ZQ370R 340x15, 直, 圆刃

圆骨凿 (滚花柄)  
Gouge



ZQ371R 340x10, 弯, 圆刃

ZQ372R 340x15, 弯, 圆刃

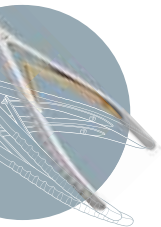

半圆脱臼骨凿  
Dislocation Chisel



**ZQ2028R** 215x22.5, 缩口式

半圆脱臼骨凿  
Dislocation Chisel



**ZQ2029R** 215x22.5, 外翻式

截骨刀 (六角柄)  
Chisel



- ★ **ZQ401R** 230x8, 直, 平刃, 六角柄
- ★ **ZQ402R** 230x10, 直, 平刃, 六角柄
- ★ **ZQ403R** 230x12, 直, 平刃, 六角柄

- ★ **ZQ398R** 230x15, 直, 平刃, 六角柄
- ★ **ZQ399R** 230x16, 直, 平刃, 六角柄
- ★ **ZQ404R** 230x18, 直, 平刃, 六角柄

- ★ **ZQ400R** 230x20, 直, 平刃, 六角柄
- ★ **ZQ405R** 230x24, 直, 平刃, 六角柄
- ★ **ZQ406R** 230x30, 直, 平刃, 六角柄

截骨刀 (六角柄)  
Chisel



- ★ **ZQ411R** 230x8, 弯, 平刃, 六角柄
- ★ **ZQ412R** 230x12, 弯, 平刃, 六角柄

- ★ **ZQ413R** 230x18, 弯, 平刃, 六角柄
- ★ **ZQ414R** 230x24, 弯, 平刃, 六角柄

**ZQ415R** 230x30, 弯, 平刃, 六角柄

截骨刀 (六角柄)  
Chisel



- ★ **ZQ407R** 230x10, 直, 圆刃, 六角柄
- ZQ408R** 230x15, 直, 圆刃, 六角柄

- ZQ409R** 230x20, 直, 圆刃, 六角柄
- ZQ410R** 230x25, 直, 圆刃, 六角柄

截骨刀 (六角柄)  
Chisel, curved



- ★ **ZQ416R** 230x10, 弯, 圆刃, 六角柄
- ZQ417R** 230x15, 弯, 圆刃, 六角柄

- ZQ418R** 230x20, 弯, 圆刃, 六角柄
- ZQ419R** 230x25, 弯, 圆刃, 六角柄

骨凿 (六方柄)  
Chisel



- ★ **ZQ319R** 240x6, 直, 平刃, 六方柄
- ★ **ZQ373R** 240x8, 直, 平刃, 六方柄
- ★ **ZQ374R** 240x10, 直, 平刃, 六方柄

- ★ **ZQ375R** 240x12, 直, 平刃, 六方柄
- ★ **ZQ376R** 240x15, 直, 平刃, 六方柄
- ★ **ZQ377R** 240x18, 直, 平刃, 六方柄

- ★ **ZQ378R** 240x20, 直, 平刃, 六方柄
- ★ **ZQ379R** 240x25, 直, 平刃, 大方柄
- ★ **ZQ380R** 240x30, 直, 平刃, 六方柄

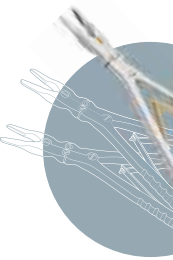

矫形外科(骨科)  
Orthopaedic Instruments

薄型限位骨刀  
Chisel



**ZQ800R** 220x6x6, 直, 单斜刃

**ZQ801R** 220x7x6, 直, 单斜刃

**ZQ802R** 220x8x7, 直, 单斜刃

薄型限位骨刀  
Chisel

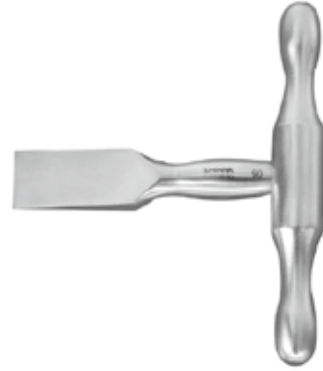

**ZQ353R** 90, 直, 双斜刃

髓核凿 (骨刀)  
Chisel oval



★**ZQ705RN/RB** 235xΦ6

**ZQ706RN/RB** 235xΦ8

**ZQ707RN/RB** 235xΦ10

髓核凿 (骨刀)  
Chisel oval



**ZQ708RN/RB** 6.5x5.2, 椭圆

**ZQ709RN/RB** 8.5x7.2, 椭圆

**ZQ710RN/RB** 10.5x9.2, 椭圆

半月板刀  
Meniscotome, left curved



★**ZQ246R** 170x6, 左弯

半月板刀  
Meniscotome, right curved



★**ZQ247R** 170x6, 右弯

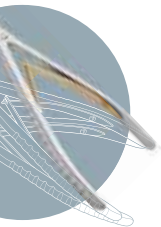



半月板刀  
 Meniscotome, straight

★ZQ248R 170x6, 直型



鹅眉型骨凿 (胶木柄)  
 Gouge



★ZQ820R 240x6, 直头平口, 单斜刃  
 ★ZQ821R 240x8, 直头平口, 单斜刃  
 ★ZQ822R 240x10, 直头平口, 单斜刃  
 ZQ823R 240x12, 直头平口, 单斜刃  
 ZQ824R 260x6, 直头平口, 单斜刃  
 ★ZQ825R 260x8, 直头平口, 单斜刃

★ZQ826R 260x10, 直头平口, 单斜刃  
 ZQ827R 260x12, 直头平口, 单斜刃  
 ZQ828R 280x6, 直头平口, 单斜刃  
 ZQ829R 280x8, 直头平口, 单斜刃  
 ZQ830R 280x10, 直头平口, 单斜刃  
 ZQ831R 280x12, 直头平口, 单斜刃

ZQ894R 300x6, 直头平口, 单斜刃  
 ZQ895R 300x8, 直头平口, 单斜刃  
 ZQ896R 300x10, 直头平口, 单斜刃  
 ZQ897R 300x12, 直头平口, 单斜刃

平滑刀 (非圆座胶木柄)  
 Osteotome



★ZQ1162R 260x8, 超薄双斜刃  
 ★ZQ1163R 260x10, 超薄双斜刃  
 ★ZQ1164R 260x12, 超薄双斜刃  
 ★ZQ1165R 260x15, 超薄双斜刃  
 ★ZQ1166R 260x18, 超薄双斜刃  
 ★ZQ1167R 260x20, 超薄双斜刃

★ZQ1168R 260x25, 超薄双斜刃  
 ★ZQ1169R 260x30, 超薄双斜刃  
 ★ZQ1170R 300x8, 超薄双斜刃  
 ★ZQ1171R 300x10, 超薄双斜刃  
 ★ZQ1172R 300x12, 超薄双斜刃  
 ★ZQ1173R 300x15, 超薄双斜刃

★ZQ1174R 300x18, 超薄双斜刃  
 ★ZQ1175R 300x20, 超薄双斜刃  
 ★ZQ1176R 300x25, 超薄双斜刃  
 ZQ1177R 300x30, 超薄双斜刃

圆骨刀 (非圆座胶木柄)  
 Gouge

ZQ1180R 260x8x30°, 前弯, 平口, 超薄刃  
 ZQ1181R 260x10x30°, 前弯, 平口, 超薄刃

ZQ1182R 260x12x30°, 前弯, 平口, 超薄刃  
 ZQ1183R 260x15x30°, 前弯, 平口, 超薄刃

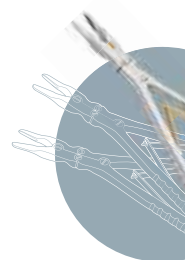

矫形外科(骨科)  
 Orthopaedic Instruments

圆骨刀 (非圆座胶木柄)  
Gouge



- ZQ1186R 260x6, 长弧, 圆口, 超薄刃
- ZQ1187R 260x8, 长弧, 圆口, 超薄刃
- ZQ1188R 260x10, 长弧, 圆口, 超薄刃

- ZQ1189R 260x12, 长弧, 圆口, 超薄刃
- ZQ1190R 260x15, 长弧, 圆口, 超薄刃

圆骨刀 (非圆座胶木柄)  
Gouge



- ★ZQ1193R 260x6, 短弧, 圆口, 超薄刃
- ZQ1194R 260x9, 短弧, 圆口, 超薄刃

- ZQ1195R 260x12, 短弧, 圆口, 超薄刃

圆骨刀 (非圆座胶木柄)  
Gouge



- ZQ1198R 260x9x15°, 前弯, 圆口, 超薄刃
- ZQ1199R 260x12x15°, 前弯, 圆口, 超薄刃

- ZQ1200R 260x15x15°, 前弯, 圆口, 超薄刃

圆骨刀 (非圆座胶木柄)  
Gouge



- ZQ1203R 260x9x15°, 后弯, 圆口, 超薄刃
- ZQ1204R 260x12x15°, 后弯, 圆口, 超薄刃

- ZQ1205R 260x15x15°, 后弯, 圆口, 超薄刃

圆骨刀 (非圆座胶木柄)  
Gouge



- ZQ1208R 260x6, 平直口, 超薄刃
- ZQ1209R 260x8, 平直口, 超薄刃
- ZQ1210R 260x10, 平直口, 超薄刃

- ZQ1211R 260x12, 平直口, 超薄刃
- ZQ1212R 260x15, 平直口, 超薄刃

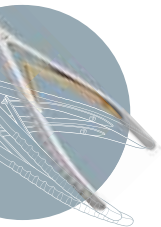

矫形外科 (骨科)  
Orthopaedic Instruments

平骨刀 (非圆座胶木柄)  
Osteotome



- ZQ1215R 300x8, 短弧, 超薄斜刀
- ★ZQ1226R 300x10, 短弧, 超薄斜刀
- ZQ1217R 300x12, 短弧, 超薄斜刀

- ★ZQ1218R 300x15, 短弧, 超薄斜刀
- ZQ1219R 300x18, 短弧, 超薄斜刀
- ZQ1220R 300x20, 短弧, 超薄斜刀

- ZQ1221R 300x25, 短弧, 超薄斜刀
- ZQ1222R 300x30, 短弧, 超薄斜刀

圆骨刀 (非圆座胶木柄)  
Gouge



- ZQ1223R 260x6, 枪形, 超薄刃
- ZQ1224R 260x8, 枪形, 超薄刃

- ZQ1225R 260x10, 枪形, 超薄刃

平骨刀 (非圆座胶木柄)  
Osteotome



- ZQ1228R 300x8, 梯形, 超薄斜刀
- ZQ1229R 300x10, 梯形, 超薄斜刀

- ZQ1230R 300x12, 梯形, 超薄斜刀
- ZQ1231R 300x15, 梯形, 超薄斜刀

圆骨刀 (非圆座胶木柄)  
Gouge



- ZQ1236R 260x9, 直圆头, 超薄刃
- ZQ1237R 260x12, 直圆头, 超薄刃

- ZQ1238R 260x15, 直圆头, 超薄刃

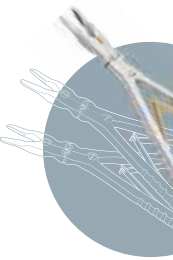

矫形外科(骨科)  
Orthopaedic Instruments

平骨刀 (硅胶柄)  
Osteotome, silicon handle



- ZQ1597R 270x6, 超薄圆刃
- ★ZQ1632R 270x8, 超薄圆刃
- ★ZQ1633R 270x10, 超薄圆刃
- ★ZQ1634R 270x12, 超薄圆刃
- ★ZQ1635R 270x15, 超薄圆刃
- ★ZQ1636R 270x18, 超薄圆刃
- ★ZQ1637R 270x20, 超薄圆刃
- ★ZQ1638R 270x25, 超薄圆刃
- ★ZQ1639R 270x30, 超薄圆刃
- ZQ1595R 270x6, 普通圆刃
- ★ZQ1640R 270x8, 普通圆刃
- ★ZQ1641R 270x10, 普通圆刃
- ★ZQ1642R 270x12, 普通圆刃
- ★ZQ1643R 270x15, 普通圆刃
- ZQ1644R 270x18, 普通圆刃
- ZQ1645R 270x20, 普通圆刃
- ZQ1646R 270x25, 普通圆刃
- ZQ1647R 270x30, 普通圆刃
- ZQ1599R 300x6, 超薄圆刃
- ★ZQ1600R 300x8, 超薄圆刃
- ★ZQ1601R 300x10, 超薄圆刃
- ★ZQ1602R 300x12, 超薄圆刃
- ★ZQ1603R 300x15, 超薄圆刃
- ★ZQ1604R 300x18, 超薄圆刃
- ★ZQ1605R 300x20, 超薄圆刃
- ZQ1606R 300x25, 超薄圆刃
- ZQ1607R 300x30, 超薄圆刃
- ZQ1596R 300x6, 普通圆刃
- ★ZQ1608R 300x8, 普通圆刃
- ★ZQ1609R 300x10, 普通圆刃
- ★ZQ1610R 300x12, 普通圆刃
- ★ZQ1611R 300x15, 普通圆刃
- ★ZQ1612R 300x18, 普通圆刃
- ZQ1613R 300x20, 普通圆刃
- ZQ1614R 300x25, 普通圆刃
- ZQ1615R 300x30, 普通圆刃

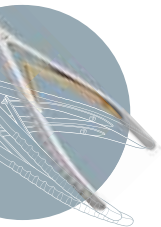

矫形外科 (骨科)  
Orthopaedic Instruments

平骨刀 (硅胶柄)  
Osteotome, silicon handle



- ZQ1648R 300x8, 梯形, 超薄圆刃
- ZQ1649R 300x10, 梯形, 超薄圆刃
- ZQ1650R 300x12, 梯形, 超薄圆刃
- ZQ1651R 300x15, 梯形, 超薄圆刃
- ZQ1652R 300x18, 梯形, 超薄圆刃

平骨刀 (硅胶柄)  
Osteotome, silicon handle



- ★ **ZQ1678R** 300x8 ,短弧,超薄圆刃
- ZQ1679R** 300x10 ,短弧,超薄圆刃
- ZQ1680R** 300x12 ,短弧,超薄圆刃
- ZQ1681R** 300x15 ,短弧,超薄圆刃
- ZQ1682R** 300x18 ,短弧,超薄圆刃
- ZQ1683R** 300x20 ,短弧,超薄圆刃
- ZQ1684R** 300x25 ,短弧,超薄圆刃
- ZQ1685R** 300x30 ,短弧,超薄圆刃

圆骨刀 (硅胶柄)  
Gouge, silicon handle



- ZQ1818R** 270x6 ,长弧,圆口,超薄刃
- ZQ1819R** 270x8 ,长弧,圆口,超薄刃
- ZQ1820R** 270x10 ,长弧,圆口,超薄刃
- ZQ1821R** 270x12 ,长弧,圆口,超薄刃
- ZQ1822R** 270x15 ,长弧,圆口,超薄刃

圆骨刀 (硅胶柄)  
Gouge, silicon handle



- ZQ1838R** 270x6 ,平直口,超薄刃
- ZQ1839R** 270x8 ,平直口,超薄刃
- ZQ1840R** 270x10 ,平直口,超薄刃
- ZQ1841R** 270x12 ,平直口,超薄刃
- ZQ1842R** 270x15 ,平直口,超薄刃

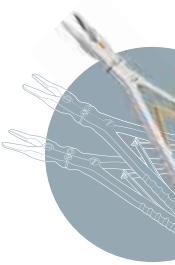

矫形外科(骨科)  
Orthopaedic Instruments

圆骨刀 (硅胶柄)  
Gouge, silicon handle



- ★ZQ1658R 270x6 ,直圆口,超薄刃
- ★ZQ1659R 270x8 ,直圆口,超薄刃
- ZQ1660R 270x10 ,直圆口,超薄刃
- ZQ1661R 270x12 ,直圆口,超薄刃
- ZQ1662R 270x15 ,直圆口,超薄刃

圆骨刀 (硅胶柄)  
Gouge, silicon handle



- ZQ1748R 270x9x15° ,超薄刃,前弯
- ZQ1749R 270x12x15° ,超薄刃,前弯
- ZQ1750R 270x15x15° ,超薄刃,前弯

圆骨刀 (硅胶柄)  
Gouge, silicon handle



- ZQ1760R 270x9x15° ,超薄刃,后弯
- ZQ1761R 270x12x15° ,超薄刃,后弯
- ZQ1762R 270x15x15° ,超薄刃,后弯

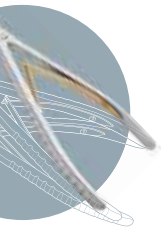

圆骨刀 (硅胶柄)  
Gouge, silicon handle



- ZQ1772R 270x9x30° , 超薄刃, 前弯
- ZQ1773R 270x12x30° , 超薄刃, 前弯
- ZQ1774R 270x15x30° , 超薄刃, 前弯

圆骨刀 (硅胶柄)  
Gouge, silicon handle



- ZQ1784R 270x6, 梯形, 圆口, 超薄刃
- ZQ1785R 270x8, 梯形, 圆口, 超薄刃
- ZQ1786R 270x10, 梯形, 圆口, 超薄刃

圆骨刀 (硅胶柄)  
Gouge, silicon handle



- ZQ1806R 270x6, 短弧, 圆口, 超薄刃
- ZQ1807R 270x9, 短弧, 圆口, 超薄刃
- ZQ1808R 270x12, 短弧, 圆口, 超薄刃

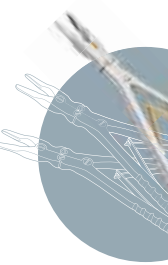

矫形外科(骨科)  
Orthopaedic Instruments

骨膜剥离器  
Periosteal Raspatory



- ★ZQ733R 150x3 直平刃
- ★ZQ734R 150x4 直平刃

- ZQ735R 150x5 直平刃
- ZQ736R 150x6 直平刃

骨膜剥离器  
Periosteal Raspatory



- ★ZQ737R 150x3 弯圆刃
- ★ZQ738R 150x4 弯圆刃

- ★ZQ739R 150x5 弯圆刃
- ★ZQ740R 150x6 弯圆刃

骨膜剥离器  
Periosteal Raspatory



- ZQ741R 160x11 直平刃

骨膜剥离器  
Periosteal Raspatory



- ★ZQ742R 160x11 弯平刃

骨膜剥离器  
Periosteal Raspatory



- ★ZQ633R 160x5, 微弯

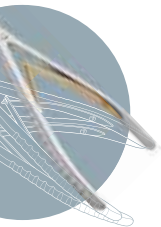

矫形外科(骨科)  
Orthopaedic Instruments



骨膜剥离器  
Periosteal Raspatory



**ZQ634R** 160x5, 深弯

骨膜分离器  
Periosteal Raspatory



**ZQ635R** 160x5, 微弯

骨膜分离器  
Periosteal Raspatory



★**ZQ636R** 160x5, 深弯

骨膜剥离器  
Periosteal Raspatory



- |                                |                                |                                |                                |
|--------------------------------|--------------------------------|--------------------------------|--------------------------------|
| ★ <b>ZQ983RN</b> 180x6, 弯, 圆刃  | ★ <b>ZQ987RN</b> 220x6, 弯, 圆刃  | ★ <b>ZQ985RN</b> 180x15, 弯, 圆刃 | ★ <b>ZQ991RN</b> 220x15, 弯, 圆刃 |
| ★ <b>ZQ767R</b> 180x8, 弯, 圆刃   | ★ <b>ZQ988RN</b> 220x8, 弯, 圆刃  | ★ <b>ZQ986RN</b> 180x20, 弯, 圆刃 | ★ <b>ZQ992RN</b> 220x20, 弯, 圆刃 |
| ★ <b>ZQ768R</b> 180x10, 弯, 圆刃  | ★ <b>ZQ989RN</b> 220x10, 弯, 圆刃 | ★ <b>ZQ997RN</b> 180x18, 弯, 圆刃 | ★ <b>ZQ998RN</b> 220x18, 弯, 圆刃 |
| ★ <b>ZQ984RN</b> 180x12, 弯, 圆刃 | ★ <b>ZQ990RN</b> 220x12, 弯, 圆刃 |                                |                                |

骨膜剥离器  
Periosteal Raspatory



★**ZQ1251R** 200x11, 弯

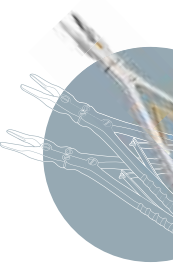

矫形外科(骨科)  
Orthopaedic Instruments

骨膜剥离器  
Periosteal Raspatory



- |          |               |          |               |          |               |
|----------|---------------|----------|---------------|----------|---------------|
| ★ ZQ686R | 180×6, 弯, 平刃  | ★ ZQ688R | 180×12, 弯, 平刃 | ★ ZQ698R | 180×20, 弯, 平刃 |
| ★ ZQ687R | 180×8, 弯, 平刃  | ★ ZQ770R | 180×15, 弯, 平刃 | ZQ690R   | 180×22, 弯, 平刃 |
| ★ ZQ694R | 180×10, 弯, 平刃 | ★ ZQ689R | 180×18, 弯, 平刃 | ZQ691R   | 180×25, 弯, 平刃 |
| ★ ZQ769R | 180×11, 弯, 平刃 |          |               |          |               |

骨膜剥离器  
Periosteal Raspatory



- |          |               |          |               |          |               |
|----------|---------------|----------|---------------|----------|---------------|
| ★ ZQ692R | 220×6, 弯, 平刃  | ★ ZQ695R | 220×12, 弯, 平刃 | ★ ZQ846R | 220x20, 弯, 平刃 |
| ★ ZQ693R | 220×8, 弯, 平刃  | ★ ZQ845R | 220×15, 弯, 平刃 | ZQ699R   | 220x22, 弯, 平刃 |
| ★ ZQ844R | 220×10, 弯, 平刃 | ★ ZQ697R | 220×18, 弯, 平刃 | ZQ700R   | 220x25, 弯, 平刃 |

神经剥离器  
Nerve Raspatory

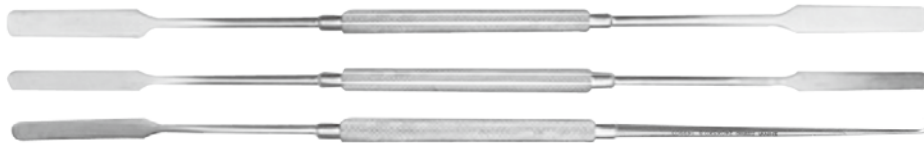

- |             |       |              |                  |
|-------------|-------|--------------|------------------|
| ★ ZQ755R/RN | 240x3 | ★ ZQ757R/RN  | 240x5xφ1, 带钩     |
| ★ ZQ756R/RN | 240x5 | ★ ZQ1260R/RN | 240x5xφ0.7, 带钩带刃 |

神经剥离器  
Nerve Raspatory



- |            |                       |
|------------|-----------------------|
| ★ ZQ1258RN | 240x5xφ0.8, 带钩带槽, 颈椎型 |
| ★ ZQ1259RN | 240x5xφ1, 带钩带槽, 腰椎型   |

神经剥离器  
Nerve Raspatory

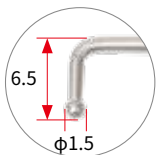

- ZQ1257RN 240×5, 带钩

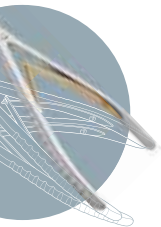

矫形外科(骨科)  
Orthopaedic Instruments

双头骨膜剥离器  
Periosteal Raspatory



★ZK358R 190, 2#, 滚花柄, 90°/弯

双头骨膜剥离器  
Periosteal Raspatory



★ZK359R 200, 1#, 滚花柄, 弯/弯

双头骨膜剥离器  
Periosteal Raspatory



★ZQ771R 270x12x15

双头骨膜剥离器  
Periosteal Raspatory



★ZQ751R 200x4, 弯/弯, 扁柄

双头骨膜剥离器  
Periosteal Raspatory



★ZQ753R 200x5.6/5.2

双头骨膜剥离器  
Periosteal Raspatory



★ZQ772R 200x5, 侧弯/侧弯, 扁柄

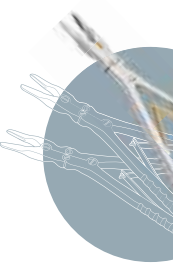

矫形外科(骨科)  
Orthopaedic Instruments

骨膜剥离器 (胶木柄)  
Periosteal Raspatory



- ★ZQ543R 240x8 直平刃
- ★ZQ544R 240x10 直平刃

- ★ZQ545R 240x14 直平刃

骨膜剥离器 (胶木柄)  
Periosteal Raspatory



- ★ZQ546R 240x8 弯平刃
- ★ZQ547R 240x10 弯平刃

- ★ZQ548R 240x14 弯平刃

骨膜剥离器 (胶木柄)  
Periosteal Raspatory



- ZQ549R 240x8 弯圆刃
- ZQ550R 240x10 弯圆刃

- ZQ551R 240x14 弯圆刃

骨膜剥离器  
Periosteal Raspatory



- ZQ760R 280x10x90°, 角弯

骨膜剥离器 (滚花柄)  
Periosteal Raspatory



- ★ZQ552R 280x16 直圆刃, 重切削型
- ★ZQ553R 280x20 直圆刃, 重切削型

- ★ZQ554R 280x24 直圆刃, 重切削型

骨膜剥离器 (滚花柄)  
Periosteal Raspatory



- ★ZQ555R 280x16 弯圆刃, 重切削型
- ★ZQ556R 280x20 弯圆刃, 重切削型

- ★ZQ557R 280x24 弯圆刃, 重切削型

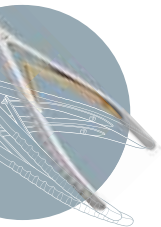

骨膜剥离器 (胶木柄)  
Periosteal Raspatory



- ★ZQ558R 280x12 平直刃
- ★ZQ559R 280x16 平直刃
- ★ZQ560R 280x20 平直刃

骨膜剥离器 (胶木柄)  
Periosteal Raspatory



- ★ZQ561R 280x12 圆弯刃
- ★ZQ562R 280x16 圆弯刃
- ★ZQ563R 280x20 圆弯刃

骨膜剥离器 (胶木柄)  
Periosteal Raspatory



- ZQ564R 330x8 圆弯刃
- ZQ565R 330x12 圆弯刃
- ZQ566R 330x16 圆弯刃

骨膜分离器 (胶木柄)  
Periosteal Raspatory



- ZQ795R 300xΦ15, 锐 sharp
- ZQ796R 300xΦ15, 钝 blunt
- ZQ797R 300xΦ20, 锐 sharp
- ZQ798R 300xΦ20, 钝 blunt

骨膜分离器 (胶木柄)  
Periosteal Raspatory



- ZQ787RB 300xΦ20, 锐弯 sharp
- ★ZQ788RB 300xΦ20, 钝弯 blunt

骨膜分离器 (铝合金柄)  
Periosteal Raspatory



- ZQ781RN 300xΦ15, 锐 sharp
- ZQ782RN 300xΦ15, 钝 blunt
- ZQ783RN 300xΦ20, 锐 sharp
- ZQ784RN 300xΦ20, 钝 blunt

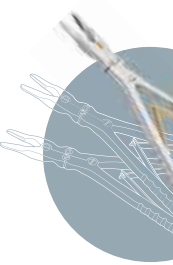

骨刮匙 (六方柄)  
 Bone Curette left curved



**ZQ440R** 150x2 左V头 Left      **ZQ441R** 150x3 左V头 Left

骨刮匙 (六方柄)  
 Bone Curette right curved



**ZQ442R** 150x2 右V头 Right      **ZQ443R** 150x3 右V头 Right

骨刮匙  
 Bone Curette



★**ZQ638R** 160x3      ★**ZQ637R** 160x2      ★**ZQ639R** 160x4

骨刮匙 (六方柄)  
 Bone Curette



★**ZQ444R** 170x3 左弯头 Left Curved      ★**ZQ445R** 170x6 左弯头 Left Curved

骨刮匙 (六方柄)  
 Bone Curette



★**ZQ446R** 170x3 右弯头 Right Curved      ★**ZQ447R** 170x6 右弯头 Right Curved

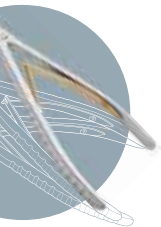

矫形外科 (骨科)  
 Orthopaedic Instruments

骨刮匙 (六方柄)  
Bone Curette



- |         |       |         |        |         |       |
|---------|-------|---------|--------|---------|-------|
| ★ZQ448R | 170x2 | ★ZQ453R | 170x8  | ★ZQ458R | 210x4 |
| ★ZQ449R | 170x3 | ★ZQ454R | 170x10 | ★ZQ459R | 210x5 |
| ★ZQ450R | 170x4 | ZQ455R  | 170x12 | ★ZQ460R | 210x6 |
| ★ZQ451R | 170x5 | ZQ456R  | 170x14 | ★ZQ461R | 210x8 |
| ★ZQ452R | 170x6 | ★ZQ457R | 210x3  |         |       |

骨刮匙 (六方柄)  
Bone Curette



ZQ500R 250x3x110°, 角弯

骨刮匙 (六方柄)  
Bone Curette



- |         |       |         |       |
|---------|-------|---------|-------|
| ★ZK633R | 200x5 | ★ZK705R | 220x3 |
| ★ZK635R | 200x8 | ★ZK706R | 220x4 |

骨刮匙 (带刻度, 六方柄)  
Bone Curette, graduated



- |         |           |         |           |         |           |
|---------|-----------|---------|-----------|---------|-----------|
| ★ZQ462R | 230x2x10° | ZQ472R  | 230x3x25° | ★ZQ481R | 250x6x15° |
| ★ZQ463R | 230x3x10° | ★ZQ473R | 230x4x25° | ZQ482R  | 250x4x20° |
| ★ZQ464R | 230x4x10° | ZQ474R  | 230x2x30° | ZQ483R  | 250x5x20° |
| ★ZQ465R | 230x2x15° | ZQ475R  | 230x3x30° | ★ZQ484R | 250x6x20° |
| ★ZQ466R | 230x3x15° | ★ZQ476R | 230x4x30° | ZQ485R  | 250x4x25° |
| ★ZQ467R | 230x4x15° | ★ZQ477R | 250x4x10° | ZQ486R  | 250x5x25° |
| ZQ468R  | 230x2x20° | ★ZQ478R | 250x5x10° | ZQ487R  | 250x6x25° |
| ★ZQ469R | 230x3x20° | ★ZQ479R | 250x6x10° | ZQ488R  | 250x4x30° |
| ★ZQ470R | 230x4x20° | ★ZQ480R | 250x4x15° | ZQ489R  | 250x5x30° |
| ★ZQ471R | 230x2x25° | ★ZQ439R | 250x5x15° | ★ZQ490R | 250x6x30° |

骨刮匙 (带刻度, 六方柄)  
Bone Curette, back curved



- |         |                   |        |                   |
|---------|-------------------|--------|-------------------|
| ★ZQ491R | 250x3x45°, 后弯, 反口 | ZQ493R | 250x5x45°, 后弯, 反口 |
| ZQ492R  | 250x4x45°, 后弯, 反口 |        |                   |

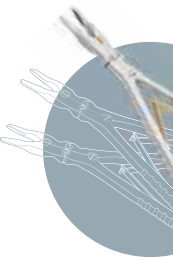

矫形外科(骨科)  
Orthopaedic Instruments

骨刮匙 (六方柄)  
Bone Curette



- |         |        |         |        |         |        |
|---------|--------|---------|--------|---------|--------|
| ★ZQ511R | 230x3  | ★ZQ519R | 250x3  | ★ZQ527R | 270x3  |
| ★ZQ512R | 230x4  | ★ZQ520R | 250x4  | ★ZQ528R | 270x4  |
| ★ZQ513R | 230x5  | ★ZQ521R | 250x5  | ★ZQ529R | 270x5  |
| ★ZQ514R | 230x6  | ★ZQ522R | 250x6  | ★ZQ530R | 270x6  |
| ★ZQ515R | 230x8  | ★ZQ523R | 250x8  | ★ZQ531R | 270x8  |
| ★ZQ516R | 230x10 | ★ZQ524R | 250x10 | ★ZQ532R | 270x10 |
| ★ZQ517R | 230x12 | ★ZQ525R | 250x12 | ★ZQ533R | 270x12 |
| ★ZQ518R | 230x14 | ★ZQ526R | 250x14 | ★ZQ534R | 270x14 |

骨刮匙 (六方柄)  
Bone Curette



- |         |            |         |            |
|---------|------------|---------|------------|
| ★ZQ494R | 250x3, 后躬式 | ★ZQ496R | 250x5, 后躬式 |
| ★ZQ495R | 250x4, 后躬式 | ★ZQ731R | 250x6, 后躬式 |

骨刮匙 (滚花柄)  
Bone Curette



- |         |                      |         |                      |         |                 |
|---------|----------------------|---------|----------------------|---------|-----------------|
| ★ZQ497R | 280x2x30°, 前弯 curved | ★ZQ499R | 280x4x30°, 前弯 curved | ★ZQ505R | 280x11 straight |
| ★ZQ498R | 280x3x30°, 前弯 curved | ★ZQ504R | 280x7 straight       | ★ZQ506R | 280x14 straight |

双头骨刮匙  
Bone Curette



- |         |              |         |               |         |               |
|---------|--------------|---------|---------------|---------|---------------|
| ★ZQ535R | 160xφ2/3x9.5 | ★ZQ537R | 180xφ6/7x15   | ★ZQ539R | 210xφ10/11x18 |
| ★ZQ536R | 160xφ4/5x13  | ★ZQ538R | 180xφ8/9x16.5 | ★ZQ540R | 210xφ12/13x20 |

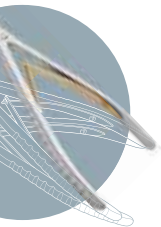

矫形外科 (骨科)  
Orthopaedic Instruments



双头骨刮匙  
Bone Curette



★ZK847R 200xφ6/5x10

★ZK848R 200xφ8/7x14

★ZK849R 200xφ10/9x17

颈椎骨刮匙 (铝合金柄)  
Bone Curette

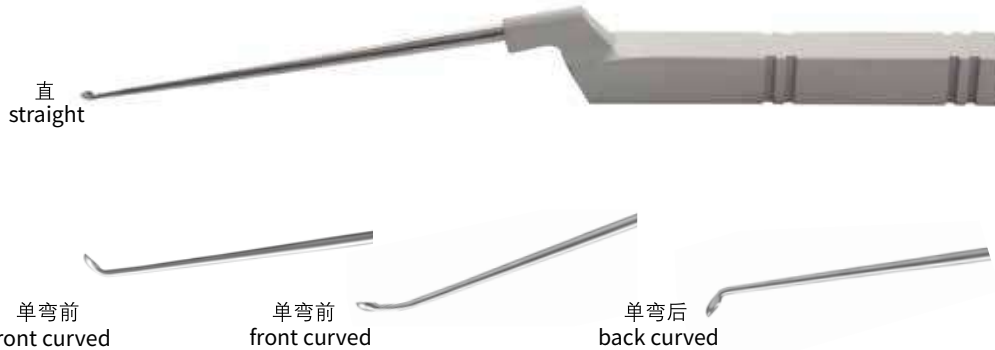

★ZQ1110RN 250x2, 直头, 枪状 straight

★ZQ1111RN 250x3, 直头, 枪状 straight

★ZQ1112RN 250x4, 直头, 枪状 straight

ZQ1113RN 250x5, 直头, 枪状 straight

★ZQ1114RN 250x2x 45°, 单弯前, 枪状 front curved

★ZQ1115RN 250x3x 45°, 单弯前, 枪状 front curved

ZQ1116RN 250x4x45°, 单弯前, 枪状 front curved

ZQ1117RN 250x5x 45°, 单弯前, 枪状 front curved

★ZQ1118RN 250x2x 45°, 单弯后, 枪状 back curved

★ZQ1119RN 250x3x45°, 单弯后, 枪状 back curved

ZQ1120RN 250x4x 45°, 单弯后, 枪状 back curved

ZQ1121RN 250x5x 45°, 单弯后, 枪状 back curved

ZQ1122RN 250x3x5°, 单弯前, 枪状 front curved

ZQ1123RN 250x3x10°, 单弯前, 枪状 front curved

ZQ1124RN 250x3x15°, 单弯前, 枪状 front curved

★ZQ1125RN 250x3x20°, 单弯前, 枪状 front curved

ZQ1126RN 250x4x 5°, 单弯前, 枪状 front curved

ZQ1127RN 250x4x 10°, 单弯前, 枪状 front curved

ZQ1128RN 250x4x15°, 单弯前, 枪状 front curved

ZQ1129RN 250x4x 20°, 单弯前, 枪状 front curved

ZQ1130RN 250x5x 5°, 单弯前, 枪状 front curved

ZQ1131RN 250x5x10°, 单弯前, 枪状 front curved

ZQ1132RN 250x5x 15°, 单弯前, 枪状 front curved

ZQ1133RN 250x5x 20°, 单弯前, 枪状 front curved

骨刮匙 (铝合金柄)  
Bone Curette



★ZQ1017RN 300x2x5°, 前弯 front curved

ZQ1018RN 300x2x10°, 前弯 front curved

★ZQ1025RN 300x3x5°, 前弯 front curved

ZQ1026RN 300x3x10°, 前弯 front curved

★ZQ1030RN 300x4, 直 straight

ZQ1033RN 300x4x5°, 前弯 front curved

★ZQ1034RN 300x4x10°, 前弯 front curved

ZQ1035RN 300x4x15°, 前弯 front curved

ZQ1038RN 300x5, 直 straight

★ZQ1041RN 300x5x5°, 前弯 front curved

ZQ1042RN 300x5x10°, 前弯 front curved

ZQ1044RN 300x5x20°, 前弯 front curved

ZQ1049RN 300x6x5°, 前弯 front curved

ZQ1050RN 300x6x10°, 前弯 front curved

ZQ1051RN 300x6x15°, 前弯 front curved

ZQ1053RN 300x6x25°, 前弯 front curved

ZQ1062RN 300x8, 直 straight

ZQ1063RN 300x8x5°, 前弯 front curved

ZQ1064RN 300x8x10°, 前弯 front curved

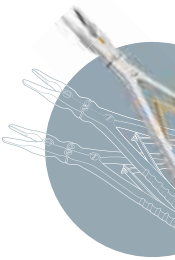

矫形外科(骨科)  
Orthopaedic Instruments

骨刮匙 (硅胶柄)  
Bone Curette, with silicon handle



- |          |           |     |              |          |            |     |              |
|----------|-----------|-----|--------------|----------|------------|-----|--------------|
| ★ZQ1340R | 260x1     | ,直  | straight     | ★ZQ1439R | 300x2      | ,直  | straight     |
| ZQ1341R  | 260x1x10° | ,前弯 | front curved | ZQ1441R  | 300x2x10°  | ,前弯 | front curved |
| ZQ1342R  | 260x1x15° | ,前弯 | front curved | ZQ1442R  | 300x2x15°  | ,前弯 | front curved |
| ZQ1344R  | 260x1x25° | ,前弯 | front curved | ZQ1444R  | 300x2x25°  | ,前弯 | front curved |
| ★ZQ1345R | 260x2     | ,直  | straight     | ★ZQ1445R | 300x3      | ,直  | straight     |
| ZQ1346R  | 260x2x10° | ,前弯 | front curved | ★ZQ1449R | 300x3x10°  | ,前弯 | front curved |
| ★ZQ1347R | 260x2x15° | ,前弯 | front curved | ZQ1450R  | 300x3x15°  | ,前弯 | front curved |
| ZQ1349R  | 260x2x25° | ,前弯 | front curved | ZQ1452R  | 300x3x25°  | ,前弯 | front curved |
| ★ZQ1350R | 260x3     | ,直  | straight     | ★ZQ1453R | 300x4      | ,直  | straight     |
| ★ZQ1354R | 260x3x10° | ,前弯 | front curved | ZQ1457R  | 300x4x10°  | ,前弯 | front curved |
| ★ZQ1355R | 260x3x15° | ,前弯 | front curved | ZQ1458R  | 300x4x15°  | ,前弯 | front curved |
| ZQ1357R  | 260x3x25° | ,前弯 | front curved | ZQ1460R  | 300x4x25°  | ,前弯 | front curved |
| ★ZQ1358R | 260x4     | ,直  | straight     | ★ZQ1461R | 300x5      | ,直  | straight     |
| ★ZQ1362R | 260x4x10° | ,前弯 | front curved | ★ZQ1465R | 300x5x10°  | ,前弯 | front curved |
| ★ZQ1363R | 260x4x15° | ,前弯 | front curved | ZQ1466R  | 300x5x15°  | ,前弯 | front curved |
| ZQ1365R  | 260x4x25° | ,前弯 | front curved | ZQ1468R  | 300x5x25°  | ,前弯 | front curved |
| ★ZQ1366R | 260x5     | ,直  | straight     | ★ZQ1469R | 300x6      | ,直  | straight     |
| ★ZQ1370R | 260x5x10° | ,前弯 | front curved | ZQ1473R  | 300x6x10°  | ,前弯 | front curved |
| ZQ1371R  | 260x5x15° | ,前弯 | front curved | ZQ1474R  | 300x6x15°  | ,前弯 | front curved |
| ZQ1373R  | 260x5x25° | ,前弯 | front curved | ZQ1476R  | 300x6x25°  | ,前弯 | front curved |
| ★ZQ1374R | 260x6     | ,直  | straight     | ★ZQ1477R | 300x7      | ,直  | straight     |
| ZQ1378R  | 260x6x10° | ,前弯 | front curved | ZQ1481R  | 300x7x10°  | ,前弯 | front curved |
| ZQ1379R  | 260x6x15° | ,前弯 | front curved | ZQ1482R  | 300x7x15°  | ,前弯 | front curved |
| ZQ1381R  | 260x6x25° | ,前弯 | front curved | ZQ1484R  | 300x7x25°  | ,前弯 | front curved |
| ★ZQ1382R | 260x7     | ,直  | straight     | ★ZQ1485R | 300x8      | ,直  | straight     |
| ZQ1386R  | 260x7x10° | ,前弯 | front curved | ZQ1487R  | 300x8x10°  | ,前弯 | front curved |
| ZQ1387R  | 260x7x15° | ,前弯 | front curved | ZQ1488R  | 300x9      | ,直  | straight     |
| ZQ1389R  | 260x7x25° | ,前弯 | front curved | ZQ1490R  | 300x9x10°  | ,前弯 | front curved |
| ZQ1433R  | 300x1     | ,直  | straight     | ★ZQ1491R | 300x10     | ,直  | straight     |
| ZQ1435R  | 300x1x10° | ,前弯 | front curved | ★ZQ1493R | 300x10x10° | ,前弯 | front curved |
| ZQ1436R  | 300x1x15° | ,前弯 | front curved | ZQ1494R  | 300x12     | ,直  | straight     |
| ZQ1438R  | 300x1x25° | ,前弯 | front curved | ZQ1496R  | 300x12x10° | ,前弯 | front curved |
|          |           |     |              | ZQ1497R  | 300x15     | ,直  | straight     |
|          |           |     |              | ★ZQ1499R | 300x15x10° | ,前弯 | front curved |

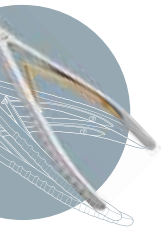

骨刮匙 (硅胶柄)  
Bone Curette Left Curved



- |                    |                   |
|--------------------|-------------------|
| ★ZQ1351R 260x3, 左弯 | ZQ1446R 300x3, 左弯 |
| ZQ1359R 260x4, 左弯  | ZQ1454R 300x4, 左弯 |
| ZQ1367R 260x5, 左弯  | ZQ1462R 300x5, 左弯 |
| ZQ1375R 260x6, 左弯  | ZQ1470R 300x6, 左弯 |
| ZQ1383R 260x7, 左弯  | ZQ1478R 300x7, 左弯 |

骨刮匙 (硅胶柄)  
Bone Curette Right Curved



- |                    |                   |
|--------------------|-------------------|
| ★ZQ1352R 260x3, 右弯 | ZQ1447R 300x3, 右弯 |
| ★ZQ1360R 260x4, 右弯 | ZQ1455R 300x4, 右弯 |
| ★ZQ1368R 260x5, 右弯 | ZQ1463R 300x5, 右弯 |
| ZQ1376R 260x6, 右弯  | ZQ1471R 300x6, 右弯 |
| ZQ1384R 260x7, 右弯  | ZQ1479R 300x7, 右弯 |

带齿骨刮匙 (硅胶柄)  
Bone Curette



- |                   |                   |                   |
|-------------------|-------------------|-------------------|
| ★ZQ1500R 300x4, 直 | ★ZQ1503R 300x7, 直 | ZQ1505R 300x9, 直  |
| ★ZQ1501R 300x5, 直 | ★ZQ1504R 300x8, 直 | ZQ1506R 300x10, 直 |
| ★ZQ1502R 300x6, 直 |                   |                   |

骨刮匙 (硅胶柄)  
Bone Curette, front curved

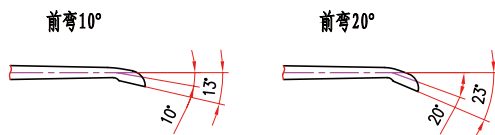

- |                        |                        |
|------------------------|------------------------|
| ZQ2351R 300x2x10°, 前弯  | ★ZQ2360R 300x2x20°, 前弯 |
| ★ZQ2352R 300x3x10°, 前弯 | ★ZQ2361R 300x3x20°, 前弯 |
| ZQ2353R 300x4x10°, 前弯  | ★ZQ2362R 300x4x20°, 前弯 |
| ★ZQ2354R 300x5x10°, 前弯 | ★ZQ2363R 300x5x20°, 前弯 |
| ★ZQ2355R 300x6x10°, 前弯 | ★ZQ2364R 300x6x20°, 前弯 |

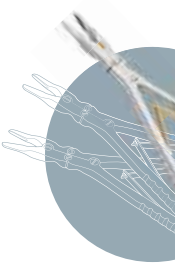

矫形外科 (骨科)  
Orthopaedic Instruments

骨刮匙 (硅胶柄)  
 Bone Curette



- ZQ1077R** 300x2x45° , 正口, 枪状杆
- ZQ1078R** 300x3x45° , 正口, 枪状杆
- ZQ1079R** 300x4x45° , 正口, 枪状杆

- ZQ1080R** 300x5x45° , 正口, 枪状杆
- ZQ1081R** 300x6x45° , 正口, 枪状杆
- ZQ1082R** 300x7x45° , 正口, 枪状杆

骨刮匙 (硅胶柄)  
 Bone Curette



- ZQ1093R** 300x2, 反口45°, 枪状杆
- ZQ1094R** 300x3, 反口45°, 枪状杆
- ZQ1095R** 300x4, 反口45°, 枪状杆

- ZQ1096R** 300x5, 反口45°, 枪状杆
- ZQ1097R** 300x6, 反口45°, 枪状杆
- ZQ1098R** 300x7, 反口45°, 枪状杆

骨刮匙 (硅胶柄)  
 Bone Curette



- ZQ1100R** 300x2, 反口90°, 枪状杆
- ZQ1101R** 300x3, 反口90°, 枪状杆
- ZQ1102R** 300x4, 反口90°, 枪状杆

- ZQ1103R** 300x5, 反口90°, 枪状杆
- ZQ1104R** 300x6, 反口90°, 枪状杆
- ZQ1105R** 300x7, 反口90°, 枪状杆

空心骨刮匙 (硅胶柄)  
 Bone Curette



- ZQ1300R** 270x3, 方头, 弯曲型

- ZQ1301R** 270x4, 方头, 弯曲型

空心骨刮匙 (硅胶柄)  
 Bone Curette



- ★ **ZQ1302R** 270x4, 直, 方头

- ★ **ZQ1303R** 270x5, 直, 方头

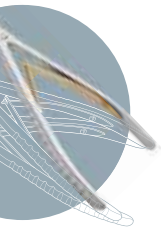

矫形外科 (骨科)  
 Orthopaedic Instruments

圆形空心骨刮匙 (硅胶柄)  
 Bone Curette

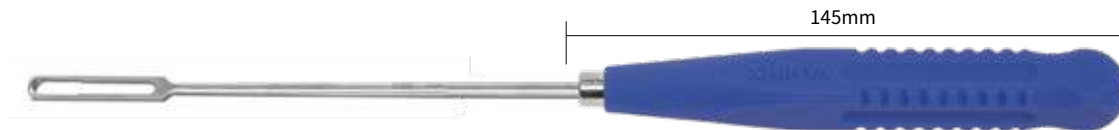

★ZQ1311R 270x8

ZQ1312R 270x9

ZQ1313R 270x10

方形空心骨刮匙 (硅胶柄)  
 Bone Curette



ZQ1314R 270x7.2x6.3

ZQ1315R 270x8.0x7.2

ZQ1316R 270x9.0x8.5

空心骨刮匙 (硅胶柄)  
 Bone Curette



ZQ1304R 280x6.5x5, 长槽型

空心终板刮匙 (硅胶柄)  
 Bone Curette



★ZQ1305R 270x8x3.4, 椭圆形, 直头, 颈椎型

★ZQ1309R 270x8x7, 椭圆形, 直头, 腰椎型

★ZQ1307R 270x8x5, 椭圆形, 直头, 胸椎型

空心终板刮匙 (硅胶柄)  
 Bone Curette



ZQ1306R 270x8x3.4x25°, 弯, 颈椎型

ZQ1310R 270x8x7x25°, 弯, 腰椎型

★ZQ1308R 270x8x5x25°, 弯, 胸椎型

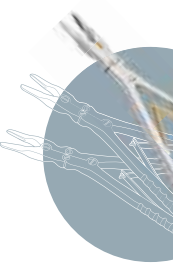

矫形外科(骨科)  
 Orthopaedic Instruments

双关节咬骨钳  
Bone Rongeur

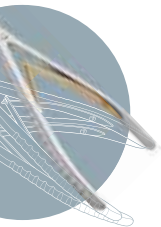

矫形外科(骨科)  
Orthopaedic Instruments

<b>ZK575R/RNh</b> 160x2,	直头, 双关节	straight	<b>ZK771R/RNh</b> 200x4x38°,	弯头, 双关节	curved
<b>ZK576R/RNh</b> 160x2x20°,	弯头, 双关节	curved	<b>ZK752R/RNh</b> 200x5,	直头, 双关节	straight
<b>ZK632R/RNh</b> 160x2x38°,	弯头, 双关节	curved	<b>ZK76TR/RNh</b> 200x5x20°,	弯头, 双关节	curved
<b>ZK682R/RNh</b> 160x3,	直头, 双关节	straight	<b>ZK768R/RNh</b> 200x5x38°,	弯头, 双关节	curved
<b>ZK685R/RNh</b> 160x3,	直尖头, 双关节	straight,sharp	★ <b>ZK605R/RNh</b> 220x2,	直头, 双关节	straight
<b>ZK683R/RNh</b> 160x3x20°,	弯头, 双关节	curved	★ <b>ZK597R/RNh</b> 220x2x20°,	弯头, 双关节	curved
<b>ZK686R/RNh</b> 160x3x20°,	弯尖头, 双关节	curved,sharp	<b>ZK601R/RNh</b> 220x2x38°,	弯头, 双关节	curved
<b>ZK684R/RNh</b> 160x3x38°,	弯头, 双关节	curved	★ <b>ZK606R/RNh</b> 220x3,	直头, 双关节	straight
<b>ZK687R/RNh</b> 160x3x38°,	弯尖头, 双关节	curved,sharp	★ <b>ZK798R/RNh</b> 220x3,	直尖头, 双关节	straight,sharp
★ <b>ZK648R/RNh</b> 180x2,	直头, 双关节	straight	★ <b>ZK598R/RNh</b> 220x3x20°,	弯头, 双关节	curved
★ <b>ZK569R/RNh</b> 180x2x20°,	弯头, 双关节	curved	★ <b>ZKT99R/RNh</b> 220x3x20°,	弯尖头, 双关节	curved,sharp
<b>ZK568R/RNh</b> 180x2x38°,	弯头, 双关节	curved	<b>ZK602R/RNh</b> 220x3x38°,	弯头, 双关节	curved
★ <b>ZK649R/RNh</b> 180x3,	直头, 双关节	straight	<b>ZK800R/RNh</b> 220x3x38°,	弯尖头, 双关节	curved,sharp
★ <b>ZK45TR/RNh</b> 180x3,	直尖头, 双关节	straight,sharp	★ <b>ZK607R/RNh</b> 220x4,	直头, 双关节	straight
★ <b>ZK652R/RNh</b> 180x3x20°,	弯头, 双关节	curved	★ <b>ZK599R/RNh</b> 220x4x20°,	弯头, 双关节	curved
<b>ZK458R/RNh</b> 180x3x20°,	弯尖头, 双关节	curved,sharp	<b>ZK603R/RNh</b> 220x4x38,	弯头, 双关节	curved
<b>ZK655R/RNh</b> 180x3x38°,	弯头, 双关节	curved	★ <b>ZK608R/RNh</b> 220x5,	直头, 双关节	straight
<b>ZK459R/RNh</b> 180x3x38°,	弯尖头, 双关节	curved,sharp	★ <b>ZK600R/RNh</b> 220x5x20°,	弯头, 双关节	curved,sharp
★ <b>ZK650R/RNh</b> 180x4,	直头, 双关节	straight	<b>ZK604R/RNh</b> 220x5x38°,	弯头, 双关节	curved,sharp
★ <b>ZK653R/RNh</b> 180x4x20°,	弯头, 双关节	curved	★ <b>ZK585R/RNh</b> 240x2,	直头, 双关节	straight
<b>ZK656R/RNh</b> 180x4x38°,	弯头, 双关节	curved	★ <b>ZK589R/RNh</b> 240x2x20°,	弯头, 双关节	curved
★ <b>ZK651R/RNh</b> 180x5,	直头, 双关节	straight	<b>ZK593R/RNh</b> 240x2x38°,	弯头, 双关节	curved
★ <b>ZK654R/RNh</b> 180x5x20°,	弯头, 双关节	curved	★ <b>ZK586R/RNh</b> 240x3,	直头, 双关节	straight
<b>ZK657R/RNh</b> 180x5x38°,	弯头, 双关节	curved	★ <b>ZK637R/RNh</b> 240x3,	直尖头, 双关节	straight,sharp
<b>ZK775R/RNh</b> 200x2,	直头, 双关节	straight	★ <b>ZK590R/RNh</b> 240x3x20°,	弯头, 双关节	curved
<b>ZKT76R/RNh</b> 200x2x20°,	弯头, 双关节	curved	★ <b>ZK641R/RNh</b> 240x3x20°,	弯尖头, 双关节	curved,sharp
<b>ZK777R/RNh</b> 200x2x38°,	弯头, 双关节	curved	<b>ZK594R/RNh</b> 240x3x38°,	弯头, 双关节	curved
<b>ZK772R/RNh</b> 200x3,	直头, 双关节	straight	<b>ZK645R/RNh</b> 240x3x38°,	弯尖头, 双关节	straight,sharp
<b>ZK795R/RNh</b> 200x3,	直尖头, 双关节	curved,sharp	★ <b>ZK587R/RNh</b> 240x4,	直头, 双关节	straight
<b>ZK773R/RNh</b> 200x3x20°,	弯头, 双关节	curved	★ <b>ZK591R/RNh</b> 240x4x20°,	弯头, 双关节	curved
<b>ZK796R/RNh</b> 200x3x20°,	弯尖头, 双关节	curved,sharp	<b>ZK595R/RNh</b> 240x4x38°,	弯头, 双关节	curved
<b>ZK774R/RNh</b> 200x3x38°,	弯头, 双关节	curved	★ <b>ZK588R/RNh</b> 240x5,	直头, 双关节	straight
<b>ZK797R/RNh</b> 200x3x38°,	弯尖头, 双关节	curved,sharp	★ <b>ZK592R/RNh</b> 240x5x20°,	弯头, 双关节	curved
<b>ZK769R/RNh</b> 200x4,	直头, 双关节	straight	<b>ZK596R/RNh</b> 240x5x38°,	弯头, 双关节	curved
<b>ZK770R/RNh</b> 200x4x20°,	弯头, 双关节	curved			

注：“RNh”后缀为纳米陶瓷超耐涂层表面  
“R”后缀为电镀表面

Note: RNh means ceramic black coating surface  
R means chrome plated surface

双关节咬骨钳  
Bone Rongeur, big opening



- ★ZK805R 240x3, 大开档, 尖头 fine tip
- ★ZK808R 240x2, 大开档
- ★ZK811R 240x3, 大开档
- ★ZK814R 240x4, 大开档
- ★ZK817R 240x5, 大开档
- ★ZK806R 240x3x20°, 大开档, 尖头 fine tip
- ★ZK809R 240x2x20°, 大开档
- ★ZK812R 240x3x20°, 大开档

- ★ZK815R 240x4x20°, 大开档
- ★ZK818R 240x5x20°, 大开档
- ZK807R 240x3x38°, 大开档, 尖头 fine tip
- ZK810R 240x2x38°, 大开档
- ZK813R 240x3x38°, 大开档
- ZK816R 240x4x38°, 大开档
- ZK819R 240x5x38°, 大开档

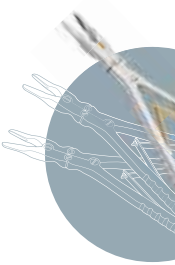

矫形外科(骨科)  
Orthopaedic Instruments

双关节咬骨钳  
Bone Rongeur



- ★ZK435R 240x8, 直头 Straight

- ★ZK436R 240x8, 微弯 Slightly curved

单关节咬骨钳  
Bone Rongeur, Curved



- ★ZK612R 180x2, 弯
- ★ZK643R 180x3, 弯
- ★ZK782R 180x4, 弯
- ★ZK784R 180x5, 弯
- ★ZK788R 180x8, 弯

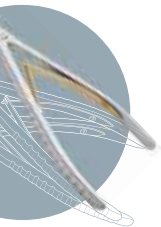

Orthopaedic Instruments  
矫形外科(骨科)

单关节咬骨钳  
Bone Rongeur, Straight



- ★ZK611R 180x2, 直
- ★ZK642R 180x3, 直
- ★ZK781R 180x4, 直
- ★ZK783R 180x5, 直
- ★ZK787R 180x8, 直



左侧角 40°双关节咬骨钳  
 Bone Rongeur left angled



- |                               |                               |                              |
|-------------------------------|-------------------------------|------------------------------|
| <b>ZK973R/RNh</b> 180x2, 直头   | <b>★ZK1060R/RNh</b> 200x4, 直头 | <b>★ZK522R/RNh</b> 220x6, 直头 |
| <b>★ZK974R/RNh</b> 180x3, 直头  | <b>ZK1061R/RNh</b> 200x5, 直头  | <b>★ZK978R/RNh</b> 240x2, 直头 |
| <b>★ZK975R/RNh</b> 180x4, 直头  | <b>★ZK1062R/RNh</b> 200x6, 直头 | <b>★ZK969R/RNh</b> 240x3, 直头 |
| <b>ZK976R/RNh</b> 180x5, 直头   | <b>★ZK679R/RNh</b> 220x2, 直头  | <b>ZK970R/RNh</b> 240x4, 直头  |
| <b>ZK977R/RNh</b> 180x6, 直头   | <b>★ZK519R/RNh</b> 220x3, 直头  | <b>ZK971R/RNh</b> 240x5, 直头  |
| <b>ZK1058R/RNh</b> 200x2, 直头  | <b>★ZK520R/RNh</b> 220x4, 直头  | <b>★ZK972R/RNh</b> 240x6, 直头 |
| <b>★ZK1059R/RNh</b> 200x3, 直头 | <b>★ZK521R/RNh</b> 220x5, 直头  |                              |

右侧角 40°双关节咬骨钳  
 Bone Rongeur right upwards angled



- |                              |                              |
|------------------------------|------------------------------|
| <b>★ZK542R</b> 240x2, 左上弯30° | <b>★ZK550R</b> 240x4, 左上弯30° |
| <b>★ZK546R</b> 240x3, 左上弯30° |                              |

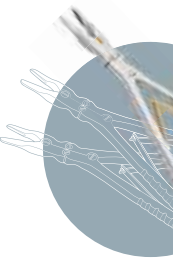

矫形外科(骨科)  
 Orthopaedic Instruments

右侧角 40°双关节咬骨钳  
Bone Rongeur right upwards angled



- ★ZK544R 240x2, 右上弯30°
- ★ZK548R 240x3, 右上弯30°

- ★ZK552R 240x4, 右上弯30°

双关节咬骨钳  
Bone Rongeur, curved



- ★ZK570R 230x3x20°, 弯头
- ★ZK571R 220x4x20°, 弯头

- ★ZK534R 230x5x20°, 弯头
- ★ZK541R 230x6x20°, 弯头

- ★ZK507R 230x8x20°, 弯头

双关节棘突咬骨钳  
Bone Rongeur



- ★ZK566R 240x16, 直

- ★ZK564RN 260x16

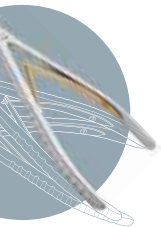

单关节咬骨剪  
Bone Shear



- ★ZL864R 140, 直 Straight
- ★ZL865R 140, 弯 Curved
- ★ZK622R 180, 直 Straight
- ★ZK623R 180, 弯 Curved

双关节咬骨剪  
Bone Shear



- ★ZK615R 220, 直 Straight
- ★ZK617R 240, 直 Straight
- ★ZK620R 240, 弯 Curved

双关节咬骨剪  
Bone Shear



- ★ZK765R 270, 直 Straight
- ★ZK766R 270, 弯 Curved

双关节棘突咬骨剪  
Bone Shear



- ★ZK565RN 290x16

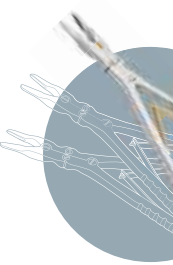

矫形外科(骨科)  
Orthopaedic Instruments

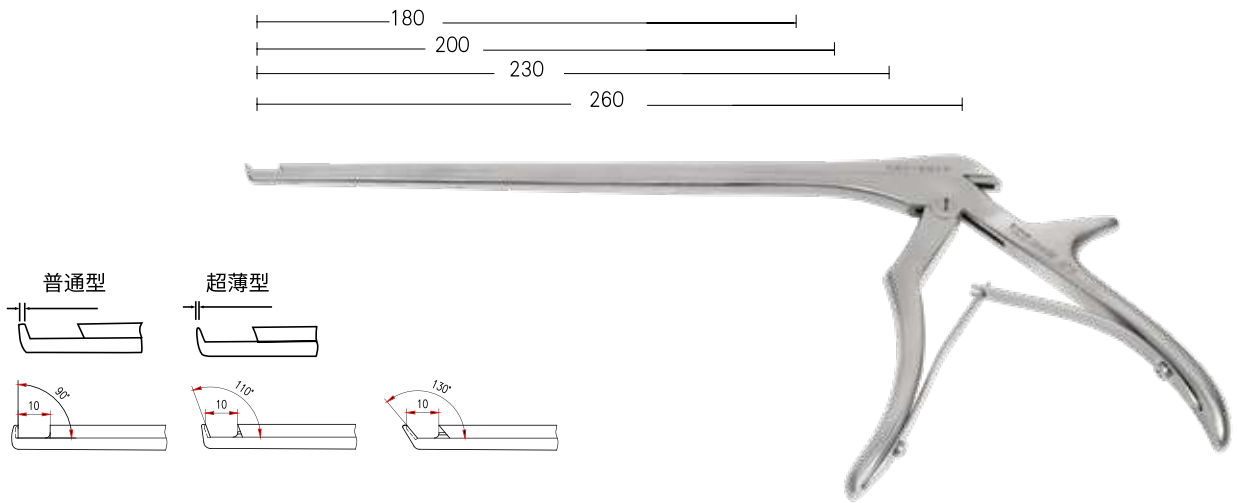

椎板咬骨钳  
Kerrison Punch

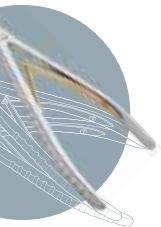

矫形外科 (骨科)  
Orthopaedic Instruments

- ZF676Rd 180x2/10x90°, 普通型
- ★ZF748Rd 200x2/10x90°, 普通型
- ★ZF678Rd 230x2/10x90°, 普通型
- ★ZF1644Rd 260x2/10x90°, 普通型
- ZF677Rd 180x3/10x90°, 普通型
- ★ZF749Rd 200x3/10x90°, 普通型
- ★ZF679Rd 230x3/10x90°, 普通型
- ★ZF1650Rd 260x3/10x90°, 普通型
- ZF710Rd 180x4/10x90°, 普通型
- ★ZF753Rd 200x4/10x90°, 普通型
- ★ZF680Rd 230x4/10x90°, 普通型
- ★ZF1358Rd 260x4/10x90°, 普通型
- ZF536Rd 180x5/10x90°, 普通型
- ★ZF537Rd 200x5/10x90°, 普通型
- ★ZF538Rd 230x5/10x90°, 普通型
- ZF1656Rd 260x5/10x90°, 普通型
- ZF681Rs 180x2/10x110°, 普通型
- ★ZF684Rs 200x2/10x110°, 普通型
- ★ZF687Rs 230x2/10x110°, 普通型
- ZF1646Rs 260x2/10x110°, 普通型
- ZF682Rs 180x3/10x110°, 普通型
- ★ZF685Rs 200x3/10x110°, 普通型
- ★ZF688Rs 230x3/10x110°, 普通型
- ZF1652Rs 260x3/10x110°, 普通型
- ZF683Rs 180x4/10x110°, 普通型
- ZF686Rs 200x4/10x110°, 普通型
- ★ZF689Rs 230x4/10x110°, 普通型
- ★ZF1360Rs 260x4/10x110°, 普通型
- ZF539Rs 180x5/10x110°, 普通型
- ZF540Rs 200x5/10x110°, 普通型
- ZF541Rs 230x5/10x110°, 普通型
- ZF1658Rs 260x5/10x110°, 普通型
- ZF690Rs 180x2/10x130°, 普通型
- ★ZF754Rs 200x2/10x130°, 普通型
- ★ZF693Rs 230x2/10x130°, 普通型
- ZF1648Rs 260x2/10x130°, 普通型
- ZF691Rs 180x3/10x130°, 普通型
- ★ZF755Rs 200x3/10x130°, 普通型
- ★ZF694Rs 230x3/10x130°, 普通型
- ★ZF1654Rs 260x3/10x130°, 普通型
- ZF692Rs 180x4/10x130°, 普通型
- ★ZF756Rs 200x4/10x130°, 普通型
- ★ZF695Rs 230x4/10x130°, 普通型
- ★ZF1362Rs 260x4/10x130°, 普通型
- ZF542Rs 180x5/10x130°, 普通型
- ZF543Rs 200x5/10x130°, 普通型
- ★ZF795Rs 230x5/10x130°, 普通型
- ZF1660Rs 260x5/10x130°, 普通型
- ZF711Rd 180x2/10x90°, 超薄型
- ★ZF715Rd 200x2/10x90°, 超薄型
- ★ZF721Rd 230x2/10x90°, 超薄型
- ZF1645Rd 260x2/10x90°, 超薄型
- ZF713Rd 180x3/10x90°, 超薄型
- ★ZF716Rd 200x3/10x90°, 超薄型
- ★ZF723Rd 230x3/10x90°, 超薄型
- ZF1651Rd 260x3/10x90°, 超薄型
- ★ZF714Rd 180x4/10x90°, 超薄型
- ★ZF719Rd 200x4/10x90°, 超薄型
- ★ZF724Rd 230x4/10x90°, 超薄型
- ZF1359Rd 260x4/10x90°, 超薄型
- ZF796Rd 180x5/10x90°, 超薄型
- ZF797Rd 200x5/10x90°, 超薄型
- ZF798Rd 230x5/10x90°, 超薄型
- ZF1657Rd 260x5/10x90°, 超薄型
- ZF751Rs 180x2/10x110°, 超薄型
- ★ZF760Rs 200x2/10x110°, 超薄型
- ★ZF479Rs 230x2/10x110°, 超薄型
- ★ZF1647Rs 260x2/10x110°, 超薄型
- ZF758Rs 180x3/10x110°, 超薄型
- ★ZF868Rs 200x3/10x110°, 超薄型
- ★ZF480Rs 230x3/10x110°, 超薄型
- ★ZF1653Rs 260x3/10x110°, 超薄型
- ZF759Rs 180x4/10x110°, 超薄型
- ★ZF869Rs 200x4/10x110°, 超薄型
- ★ZF481Rs 230x4/10x110°, 超薄型
- ★ZF1361Rs 260x4/10x110°, 超薄型
- ZF404Rs 180x5/10x110°, 超薄型
- ZF405Rs 200x5/10x110°, 超薄型
- ★ZF406Rs 230x5/10x110°, 超薄型
- ZF1659Rs 260x5/10x110°, 超薄型
- ZF482Rs 180x2/10x130°, 超薄型
- ★ZF485Rs 200x2/10x130°, 超薄型
- ★ZF488Rs 230x2/10x130°, 超薄型
- ★ZF1649Rs 260x2/10x130°, 超薄型
- ★ZF483Rs 180x3/10x130°, 超薄型
- ★ZF486Rs 200x3/10x130°, 超薄型
- ★ZF489Rs 230x3/10x130°, 超薄型
- ★ZF1655Rs 260x3/10x130°, 超薄型
- ZF484Rs 180x4/10x130°, 超薄型
- ★ZF487Rs 200x4/10x130°, 超薄型
- ★ZF490Rs 230x4/10x130°, 超薄型
- ★ZF1363Rs 260x4/10x130°, 超薄型
- ZF431Rs 180x5/10x130°, 超薄型
- ZF432Rs 200x5/10x130°, 超薄型
- ★ZF433Rs 230x5/10x130°, 超薄型
- ZF1661Rs 260x5/10x130°, 超薄型
- ZF1024Rd 180x1/10x90°, 普通型
- ZF1025Rd 200x1/10x90°, 普通型
- ★ZF1026Rd 230x1/10x90°, 普通型
- ZF1638Rd 260x1/10x90°, 普通型
- ZF1030Rd 180x1/10x110°, 普通型
- ZF1031Rd 200x1/10x110°, 普通型
- ZF1032Rd 230x1/10x110°, 普通型
- ZF1640Rd 260x1/10x110°, 普通型
- ZF799Rd 180x1/10x130°, 普通型
- ZF696Rd 200x1/10x130°, 普通型
- ZF697Rd 230x1/10x130°, 普通型
- ZF1642Rd 260x1/10x130°, 普通型
- ZF1027Rd 180x1/10x90°, 超薄型
- ZF1028Rd 200x1/10x90°, 超薄型
- ★ZF1029Rd 230x1/10x90°, 超薄型
- ZF1639Rd 260x1/10x90°, 超薄型
- ZF1033Rd 180x1/10x110°, 超薄型
- ★ZF1034Rd 200x1/10x110°, 超薄型
- ★ZF1035Rd 230x1/10x110°, 超薄型
- ZF1641Rd 260x1/10x110°, 超薄型
- ZF660Rd 180x1/10x130°, 超薄型
- ZF661Rd 200x1/10x130°, 超薄型
- ★ZF662Rd 230x1/10x130°, 超薄型
- ★ZF1643Rd 260x1/10x130°, 超薄型

ZF2055Rd 180x1.5/10x110°, 普通型  
ZF2079Rd 180x1.5/10x130°, 普通型  
ZF2031Rd 180x1.5/10x90°, 普通型  
ZF2061Rs 180x2.5/10x110°, 普通型  
ZF2085Rs 180x2.5/10x130°, 普通型  
ZF2037Rd 180x2.5/10x90°, 普通型  
ZF2067Rs 180x3.5/10x110°, 普通型  
ZF2091Rs 180x3.5/10x130°, 普通型  
ZF2043Rd 180x3.5/10x90°, 普通型  
ZF2073Rs 180x4.5/10x110°, 普通型  
ZF2097Rs 180x4.5/10x130°, 普通型  
ZF2049Rd 180x4.5/10x90°, 普通型  
ZF2057Rs 200x1.5/10x110°, 普通型  
ZF2081Rs 200x1.5/10x130°, 普通型  
ZF2033Rd 200x1.5/10x90°, 普通型  
ZF2063Rs 200x2.5/10x110°, 普通型  
ZF2087Rs 200x2.5/10x130°, 普通型  
ZF2039Rd 200x2.5/10x90°, 普通型  
ZF2069Rs 200x3.5/10x110°, 普通型  
ZF2093Rs 200x3.5/10x130°, 普通型  
ZF2045Rd 200x3.5/10x90°, 普通型  
ZF2075Rs 200x4.5/10x110°, 普通型  
ZF2099Rs 200x4.5/10x130°, 普通型  
ZF2051Rd 200x4.5/10x90°, 普通型  
ZF2059Rd 230x1.5/10x110°, 普通型  
ZF2083Rd 230x1.5/10x130°, 普通型  
ZF2035Rd 230x1.5/10x90°, 普通型  
ZF2065Rs 230x2.5/10x110°, 普通型  
ZF2089Rs 230x2.5/10x130°, 普通型  
ZF2041Rd 230x2.5/10x90°, 普通型  
ZF2071Rs 230x3.5/10x110°, 普通型  
ZF2095Rs 230x3.5/10x130°, 普通型  
ZF2047Rd 230x3.5/10x90°, 普通型  
ZF2077Rs 230x4.5/10x110°, 普通型  
ZF2101Rs 230x4.5/10x130°, 普通型  
ZF2053Rd 230x4.5/10x90°, 普通型  
ZF2003Rd 260x1.5/10x110°, 普通型  
ZF2005Rd 260x1.5/10x130°, 普通型  
ZF2001Rd 260x1.5/10x90°, 普通型  
ZF2009Rs 260x2.5/10x110°, 普通型  
ZF2011Rs 260x2.5/10x130°, 普通型

ZF2007Rd 260x2.5/10x90°, 普通型  
ZF2015Rs 260x3.5/10x110°, 普通型  
ZF2017Rs 260x3.5/10x130°, 普通型  
ZF2013Rd 260x3.5/10x90°, 普通型  
ZF2021Rs 260x4.5/10x110°, 普通型  
ZF2023Rs 260x4.5/10x130°, 普通型  
ZF2019Rd 260x4.5/10x90°, 普通型  
ZF2056Rd 180x1.5/10x110°, 超薄型  
ZF2080Rd 180x1.5/10x130°, 超薄型  
ZF2032Rd 180x1.5/10x90°, 超薄型  
ZF2062Rs 180x2.5/10x110°, 超薄型  
ZF2086Rs 180x2.5/10x130°, 超薄型  
ZF2038Rd 180x2.5/10x90°, 超薄型  
ZF2068Rs 180x3.5/10x110°, 超薄型  
ZF2092Rs 180x3.5/10x130°, 超薄型  
ZF2044Rd 180x3.5/10x90°, 超薄型  
ZF2074Rs 180x4.5/10x110°, 超薄型  
ZF2098Rs 180x4.5/10x130°, 超薄型  
ZF2050Rd 180x4.5/10x90°, 超薄型  
ZF2058Rd 200x1.5/10x110°, 超薄型  
ZF2082Rd 200x1.5/10x130°, 超薄型  
ZF2034Rd 200x1.5/10x90°, 超薄型  
ZF2064Rs 200x2.5/10x110°, 超薄型  
ZF2088Rs 200x2.5/10x130°, 超薄型  
ZF2040Rd 200x2.5/10x90°, 超薄型  
ZF2070Rs 200x3.5/10x110°, 超薄型  
ZF2094Rs 200x3.5/10x130°, 超薄型  
ZF2046Rd 200x3.5/10x90°, 超薄型  
ZF2076Rs 200x4.5/10x110°, 超薄型  
ZF2100Rs 200x4.5/10x130°, 超薄型  
ZF2052Rd 200x4.5/10x90°, 超薄型  
ZF2060Rd 230x1.5/10x110°, 超薄型  
ZF2084Rd 230x1.5/10x130°, 超薄型  
ZF2036Rd 230x1.5/10x90°, 超薄型  
ZF2066Rs 230x2.5/10x110°, 超薄型  
ZF2090Rs 230x2.5/10x130°, 超薄型  
ZF2042Rd 230x2.5/10x90°, 超薄型  
ZF2072Rs 230x3.5/10x110°, 超薄型  
ZF2096Rs 230x3.5/10x130°, 超薄型  
ZF2048Rd 230x3.5/10x90°, 超薄型  
ZF2078Rs 230x4.5/10x110°, 超薄型

ZF2102Rs 230x4.5/10x130°, 超薄型  
ZF2054Rd 230x4.5/10x90°, 超薄型  
ZF2004Rd 260x1.5/10x110°, 超薄型  
ZF2006Rd 260x1.5/10x130°, 超薄型  
ZF2002Rd 260x1.5/10x90°, 超薄型  
ZF2010Rs 260x2.5/10x110°, 超薄型  
ZF2012Rs 260x2.5/10x130°, 超薄型  
ZF2008Rd 260x2.5/10x90°, 超薄型  
ZF2016Rs 260x3.5/10x110°, 超薄型  
ZF2018Rs 260x3.5/10x130°, 超薄型  
ZF2014Rd 260x3.5/10x90°, 超薄型  
ZF2022Rs 260x4.5/10x110°, 超薄型  
ZF2024Rs 260x4.5/10x130°, 超薄型  
ZF2020Rd 260x4.5/10x90°, 超薄型

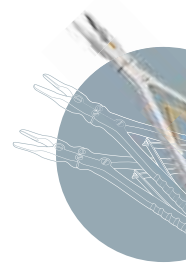

矫形外科(骨科)  
Orthopaedic Instruments

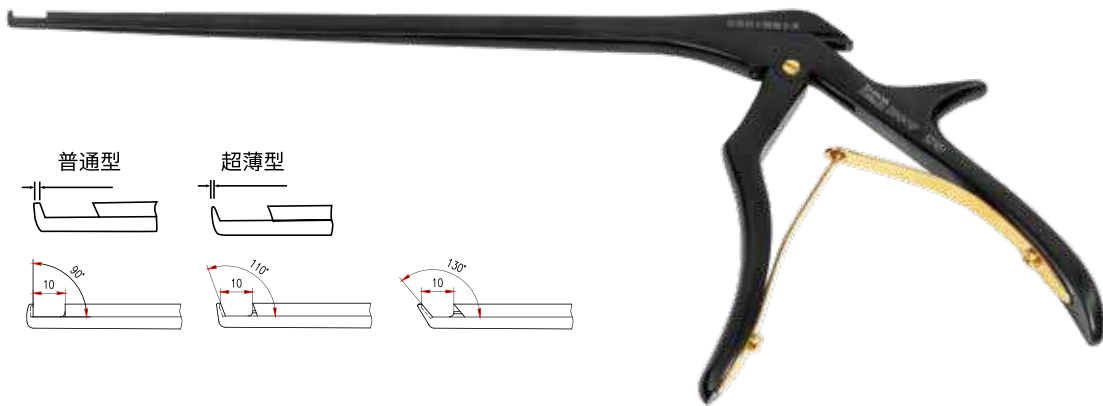

椎板咬骨钳  
Kerrison Punch

- ZF676RNdH 180x2/10x90°, 普通型, 超硬膜
- ZF748RNdH 200x2/10x90°, 普通型, 超硬膜
- ZF678RNdH 230x2/10x90°, 普通型, 超硬膜
- ZF1644RNdH 260x2/10x90°, 普通型, 超硬膜
- ZF677RNdH 180x3/10x90°, 普通型, 超硬膜
- ZF749RNdH 200x3/10x90°, 普通型, 超硬膜
- ZF679RNdH 230x3/10x90°, 普通型, 超硬膜
- ZF1650RNdH 260x3/10x90°, 普通型, 超硬膜
- ZF710RNdH 180x4/10x90°, 普通型, 超硬膜
- ZF753RNdH 200x4/10x90°, 普通型, 超硬膜
- ★ ZF680RNdH 230x4/10x90°, 普通型, 超硬膜
- ZF1358RNdH 260x4/10x90°, 普通型, 超硬膜
- ZF536RNdH 180x5/10x90°, 普通型, 超硬膜
- ZF537RNdH 200x5/10x90°, 普通型, 超硬膜
- ZF538RNdH 230x5/10x90°, 普通型, 超硬膜
- ZF1656RNdH 260x5/10x90°, 普通型, 超硬膜
- ZF681RnSh 180x2/10x110°, 普通型, 超硬膜
- ★ ZF684RnSh 200x2/10x110°, 普通型, 超硬膜
- ★ ZF687RnSh 230x2/10x110°, 普通型, 超硬膜
- ZF1646RnSh 260x2/10x110°, 普通型, 超硬膜
- ZF682RnSh 180x3/10x110°, 普通型, 超硬膜
- ★ ZF685RnSh 200x3/10x110°, 普通型, 超硬膜
- ★ ZF688RnSh 230x3/10x110°, 普通型, 超硬膜
- ZF1652RnSh 260x3/10x110°, 普通型, 超硬膜
- ZF683RnSh 180x4/10x110°, 普通型, 超硬膜
- ★ ZF686RnSh 200x4/10x110°, 普通型, 超硬膜
- ★ ZF689RnSh 230x4/10x110°, 普通型, 超硬膜
- ZF1360RnSh 260x4/10x110°, 普通型, 超硬膜
- ZF539RnSh 180x5/10x110°, 普通型, 超硬膜
- ZF540RnSh 200x5/10x110°, 普通型, 超硬膜
- ZF541RnSh 230x5/10x110°, 普通型, 超硬膜
- ZF1658RnSh 260x5/10x110°, 普通型, 超硬膜
- ZF690RnSh 180x2/10x130°, 普通型, 超硬膜
- ★ ZF754RnSh 200x2/10x130°, 普通型, 超硬膜
- ★ ZF693RnSh 230x2/10x130°, 普通型, 超硬膜
- ZF1648RnSh 260x2/10x130°, 普通型, 超硬膜
- ZF691RnSh 180x3/10x130°, 普通型, 超硬膜
- ★ ZF755RnSh 200x3/10x130°, 普通型, 超硬膜
- ★ ZF694RnSh 230x3/10x130°, 普通型, 超硬膜
- ZF1654RnSh 260x3/10x130°, 普通型, 超硬膜
- ZF692RnSh 180x4/10x130°, 普通型, 超硬膜
- ZF756RnSh 200x4/10x130°, 普通型, 超硬膜
- ★ ZF695RnSh 230x4/10x130°, 普通型, 超硬膜
- ★ ZF1362RnSh 260x4/10x130°, 普通型, 超硬膜
- ZF542RnSh 180x5/10x130°, 普通型, 超硬膜

- ZF543RnSh 200x5/10x130°, 普通型, 超硬膜
- ★ ZF795RnSh 230x5/10x130°, 普通型, 超硬膜
- ZF1660RnSh 260x5/10x130°, 普通型, 超硬膜
- ZF711RNdH 180x2/10x90°, 超薄型, 超硬膜
- ZF715RNdH 200x2/10x90°, 超薄型, 超硬膜
- ★ ZF721RNdH 230x2/10x90°, 超薄型, 超硬膜
- ZF1645RNdH 260x2/10x90°, 超薄型, 超硬膜
- ZF713RNdH 180x3/10x90°, 超薄型, 超硬膜
- ZF716RNdH 200x3/10x90°, 超薄型, 超硬膜
- ★ ZF723RNdH 230x3/10x90°, 超薄型, 超硬膜
- ZF1651RNdH 260x3/10x90°, 超薄型, 超硬膜
- ZF714RNdH 180x4/10x90°, 超薄型, 超硬膜
- ZF719RNdH 200x4/10x90°, 超薄型, 超硬膜
- ★ ZF724RNdH 230x4/10x90°, 超薄型, 超硬膜
- ZF1359RNdH 260x4/10x90°, 超薄型, 超硬膜
- ZF796RNdH 180x5/10x90°, 超薄型, 超硬膜
- ZF797RNdH 200x5/10x90°, 超薄型, 超硬膜
- ZF798RNdH 230x5/10x90°, 超薄型, 超硬膜
- ZF1657RNdH 260x5/10x90°, 超薄型, 超硬膜
- ZF751RnSh 180x2/10x110°, 超薄型, 超硬膜
- ★ ZF760RnSh 200x2/10x110°, 超薄型, 超硬膜
- ★ ZF479RnSh 230x2/10x110°, 超薄型, 超硬膜
- ZF1647RnSh 260x2/10x110°, 超薄型, 超硬膜
- ZF758RnSh 180x3/10x110°, 超薄型, 超硬膜
- ★ ZF868RnSh 200x3/10x110°, 超薄型, 超硬膜
- ★ ZF480RnSh 230x3/10x110°, 超薄型, 超硬膜
- ZF1653RnSh 260x3/10x110°, 超薄型, 超硬膜
- ZF759RnSh 180x4/10x110°, 超薄型, 超硬膜
- ★ ZF869RnSh 200x4/10x110°, 超薄型, 超硬膜
- ★ ZF481RnSh 230x4/10x110°, 超薄型, 超硬膜
- ★ ZF1361RnSh 260x4/10x110°, 超薄型, 超硬膜
- ZF404RnSh 180x5/10x110°, 超薄型, 超硬膜
- ZF405RnSh 200x5/10x110°, 超薄型, 超硬膜
- ★ ZF406RnSh 230x5/10x110°, 超薄型, 超硬膜
- ZF1659RnSh 260x5/10x110°, 超薄型, 超硬膜
- ZF482RnSh 180x2/10x130°, 超薄型, 超硬膜
- ★ ZF485RnSh 200x2/10x130°, 超薄型, 超硬膜
- ★ ZF488RnSh 230x2/10x130°, 超薄型, 超硬膜
- ★ ZF1649RnSh 260x2/10x130°, 超薄型, 超硬膜
- ★ ZF483RnSh 180x3/10x130°, 超薄型, 超硬膜
- ★ ZF486RnSh 200x3/10x130°, 超薄型, 超硬膜
- ★ ZF489RnSh 230x3/10x130°, 超薄型, 超硬膜
- ★ ZF1655RnSh 260x3/10x130°, 超薄型, 超硬膜
- ZF484RnSh 180x4/10x130°, 超薄型, 超硬膜
- ★ ZF487RnSh 200x4/10x130°, 超薄型, 超硬膜

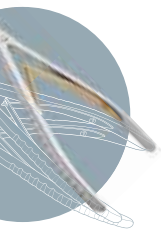

矫形外科 (骨科)  
Orthopaedic Instruments

椎板咬骨钳  
Kerrison Punch

- ★ ZF490RNsh 230x4/10x130°, 超薄型, 超硬膜
- ZF1363RNsh 260x4/10x130°, 超薄型, 超硬膜
- ZF431RNsh 180x5/10x130°, 超薄型, 超硬膜
- ZF432RNsh 200x5/10x130°, 超薄型, 超硬膜
- ★ ZF433RNsh 230x5/10x130°, 超薄型, 超硬膜
- ZF1661RNsh 260x5/10x130°, 超薄型, 超硬膜
- ZF1024RNdh 180x1/10x90°, 普通型, 超硬膜
- ZF1025RNdh 200x1/10x90°, 普通型, 超硬膜
- ★ ZF1026RNdh 230x1/10x90°, 普通型, 超硬膜
- ZF1638RNdh 260x1/10x90°, 普通型, 超硬膜
- ZF1030RNdh 180x1/10x110°, 普通型, 超硬膜
- ZF1031RNdh 200x1/10x110°, 普通型, 超硬膜
- ZF1032RNdh 230x1/10x110°, 普通型, 超硬膜
- ZF1640RNdh 260x1/10x110°, 普通型, 超硬膜
- ZF799RNdh 180x1/10x130°, 普通型, 超硬膜
- ZF696RNdh 200x1/10x130°, 普通型, 超硬膜
- ZF697RNdh 230x1/10x130°, 普通型, 超硬膜
- ZF1642RNdh 260x1/10x130°, 普通型, 超硬膜
- ZF1027RNdh 180x1/10x90°, 超薄型, 超硬膜
- ZF1028RNdh 200x1/10x90°, 超薄型, 超硬膜
- ★ ZF1029RNdh 230x1/10x90°, 超薄型, 超硬膜
- ZF1639RNdh 260x1/10x90°, 超薄型, 超硬膜
- ZF1033RNdh 180x1/10x110°, 超薄型, 超硬膜
- ★ ZF1034RNdh 200x1/10x110°, 超薄型, 超硬膜
- ★ ZF1035RNdh 230x1/10x110°, 超薄型, 超硬膜
- ZF1641RNdh 260x1/10x110°, 超薄型, 超硬膜
- ZF660RNdh 180x1/10x130°, 超薄型, 超硬膜
- ★ ZF661RNdh 200x1/10x130°, 超薄型, 超硬膜
- ★ ZF662RNdh 230x1/10x130°, 超薄型, 超硬膜
- ZF1643RNdh 260x1/10x130°, 超薄型, 超硬膜
- ZF2055RNdh 180x1.5/10x110°, 普通型, 超硬膜
- ZF2079RNdh 180x1.5/10x130°, 普通型, 超硬膜
- ZF2031RNdh 180x1.5/10x90°, 普通型, 超硬膜
- ZF2061RNsh 180x2.5/10x110°, 普通型, 超硬膜
- ZF2085RNsh 180x2.5/10x130°, 普通型, 超硬膜
- ZF2037RNdh 180x2.5/10x90°, 普通型, 超硬膜
- ZF2067RNsh 180x3.5/10x110°, 普通型, 超硬膜
- ZF2091RNsh 180x3.5/10x130°, 普通型, 超硬膜
- ZF2043RNdh 180x3.5/10x90°, 普通型, 超硬膜
- ZF2073RNsh 180x4.5/10x110°, 普通型, 超硬膜
- ZF2097RNsh 180x4.5/10x130°, 普通型, 超硬膜
- ZF2049RNdh 180x4.5/10x90°, 普通型, 超硬膜
- ZF2057RNdh 200x1.5/10x110°, 普通型, 超硬膜
- ZF2081RNdh 200x1.5/10x130°, 普通型, 超硬膜
- ZF2033RNdh 200x1.5/10x90°, 普通型, 超硬膜
- ZF2063RNsh 200x2.5/10x110°, 普通型, 超硬膜
- ZF2087RNsh 200x2.5/10x130°, 普通型, 超硬膜
- ZF2039RNdh 200x2.5/10x90°, 普通型, 超硬膜
- ZF2069RNsh 200x3.5/10x110°, 普通型, 超硬膜
- ZF2093RNsh 200x3.5/10x130°, 普通型, 超硬膜
- ZF2045RNdh 200x3.5/10x90°, 普通型, 超硬膜
- ZF2075RNsh 200x4.5/10x110°, 普通型, 超硬膜
- ZF2099RNsh 200x4.5/10x130°, 普通型, 超硬膜
- ZF2051RNdh 200x4.5/10x90°, 普通型, 超硬膜
- ZF2059RNdh 230x1.5/10x110°, 普通型, 超硬膜
- ZF2083RNdh 230x1.5/10x130°, 普通型, 超硬膜
- ZF2035RNdh 230x1.5/10x90°, 普通型, 超硬膜
- ZF2065RNsh 230x2.5/10x110°, 普通型, 超硬膜
- ZF2089RNsh 230x2.5/10x130°, 普通型, 超硬膜
- ZF2041RNdh 230x2.5/10x90°, 普通型, 超硬膜
- ZF2071RNsh 230x3.5/10x110°, 普通型, 超硬膜
- ZF2095RNsh 230x3.5/10x130°, 普通型, 超硬膜
- ZF2047RNdh 230x3.5/10x90°, 普通型, 超硬膜
- ZF2077RNsh 230x4.5/10x110°, 普通型, 超硬膜

- ZF2101RNsh 230x4.5/10x130°, 普通型, 超硬膜
- ZF2053RNdh 230x4.5/10x90°, 普通型, 超硬膜
- ZF2003RNdh 260x1.5/10x110°, 普通型, 超硬膜
- ZF2005RNdh 260x1.5/10x130°, 普通型, 超硬膜
- ZF2001RNdh 260x1.5/10x90°, 普通型, 超硬膜
- ZF2009RNsh 260x2.5/10x110°, 普通型, 超硬膜
- ZF2011RNsh 260x2.5/10x130°, 普通型, 超硬膜
- ZF2007RNdh 260x2.5/10x90°, 普通型, 超硬膜
- ZF2015RNsh 260x3.5/10x110°, 普通型, 超硬膜
- ZF2017RNsh 260x3.5/10x130°, 普通型, 超硬膜
- ZF2013RNdh 260x3.5/10x90°, 普通型, 超硬膜
- ZF2021RNsh 260x4.5/10x110°, 普通型, 超硬膜
- ZF2023RNsh 260x4.5/10x130°, 普通型, 超硬膜
- ZF2019RNdh 260x4.5/10x90°, 普通型, 超硬膜
- ZF2056RNdh 180x1.5/10x110°, 超薄型, 超硬膜
- ZF2080RNdh 180x1.5/10x130°, 超薄型, 超硬膜
- ZF2032RNdh 180x1.5/10x90°, 超薄型, 超硬膜
- ZF2062RNsh 180x2.5/10x110°, 超薄型, 超硬膜
- ZF2086RNsh 180x2.5/10x130°, 超薄型, 超硬膜
- ZF2038RNdh 180x2.5/10x90°, 超薄型, 超硬膜
- ZF2068RNsh 180x3.5/10x110°, 超薄型, 超硬膜
- ZF2092RNsh 180x3.5/10x130°, 超薄型, 超硬膜
- ZF2044RNdh 180x3.5/10x90°, 超薄型, 超硬膜
- ZF2074RNsh 180x4.5/10x110°, 超薄型, 超硬膜
- ZF2098RNsh 180x4.5/10x130°, 超薄型, 超硬膜
- ZF2050RNdh 180x4.5/10x90°, 超薄型, 超硬膜
- ZF2058RNdh 200x1.5/10x110°, 超薄型, 超硬膜
- ZF2082RNdh 200x1.5/10x130°, 超薄型, 超硬膜
- ZF2034RNdh 200x1.5/10x90°, 超薄型, 超硬膜
- ZF2064RNsh 200x2.5/10x110°, 超薄型, 超硬膜
- ZF2088RNsh 200x2.5/10x130°, 超薄型, 超硬膜
- ZF2040RNdh 200x2.5/10x90°, 超薄型, 超硬膜
- ZF2070RNsh 200x3.5/10x110°, 超薄型, 超硬膜
- ZF2094RNsh 200x3.5/10x130°, 超薄型, 超硬膜
- ZF2046RNdh 200x3.5/10x90°, 超薄型, 超硬膜
- ZF2076RNsh 200x4.5/10x110°, 超薄型, 超硬膜
- ZF2100RNsh 200x4.5/10x130°, 超薄型, 超硬膜
- ZF2052RNdh 200x4.5/10x90°, 超薄型, 超硬膜
- ZF2060RNdh 230x1.5/10x110°, 超薄型, 超硬膜
- ZF2084RNdh 230x1.5/10x130°, 超薄型, 超硬膜
- ZF2036RNdh 230x1.5/10x90°, 超薄型, 超硬膜
- ZF2066RNsh 230x2.5/10x110°, 超薄型, 超硬膜
- ZF2090RNsh 230x2.5/10x130°, 超薄型, 超硬膜
- ZF2042RNdh 230x2.5/10x90°, 超薄型, 超硬膜
- ZF2072RNsh 230x3.5/10x110°, 超薄型, 超硬膜
- ZF2096RNsh 230x3.5/10x130°, 超薄型, 超硬膜
- ZF2048RNdh 230x3.5/10x90°, 超薄型, 超硬膜
- ZF2078RNsh 230x4.5/10x110°, 超薄型, 超硬膜
- ZF2102RNsh 230x4.5/10x130°, 超薄型, 超硬膜
- ZF2054RNdh 230x4.5/10x90°, 超薄型, 超硬膜
- ZF2004RNdh 260x1.5/10x110°, 超薄型, 超硬膜
- ZF2006RNdh 260x1.5/10x130°, 超薄型, 超硬膜
- ZF2002RNdh 260x1.5/10x90°, 超薄型, 超硬膜
- ZF2010RNsh 260x2.5/10x110°, 超薄型, 超硬膜
- ZF2012RNsh 260x2.5/10x130°, 超薄型, 超硬膜
- ZF2008RNdh 260x2.5/10x90°, 超薄型, 超硬膜
- ZF2016RNsh 260x3.5/10x110°, 超薄型, 超硬膜
- ZF2018RNsh 260x3.5/10x130°, 超薄型, 超硬膜
- ZF2014RNdh 260x3.5/10x90°, 超薄型, 超硬膜
- ZF2022RNsh 260x4.5/10x110°, 超薄型, 超硬膜
- ZF2024RNsh 260x4.5/10x130°, 超薄型, 超硬膜
- ZF2020RNdh 260x4.5/10x90°, 超薄型, 超硬膜

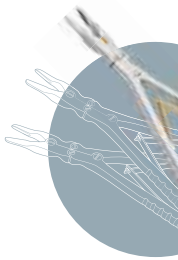

矫形外科(骨科)  
Orthopaedic Instruments

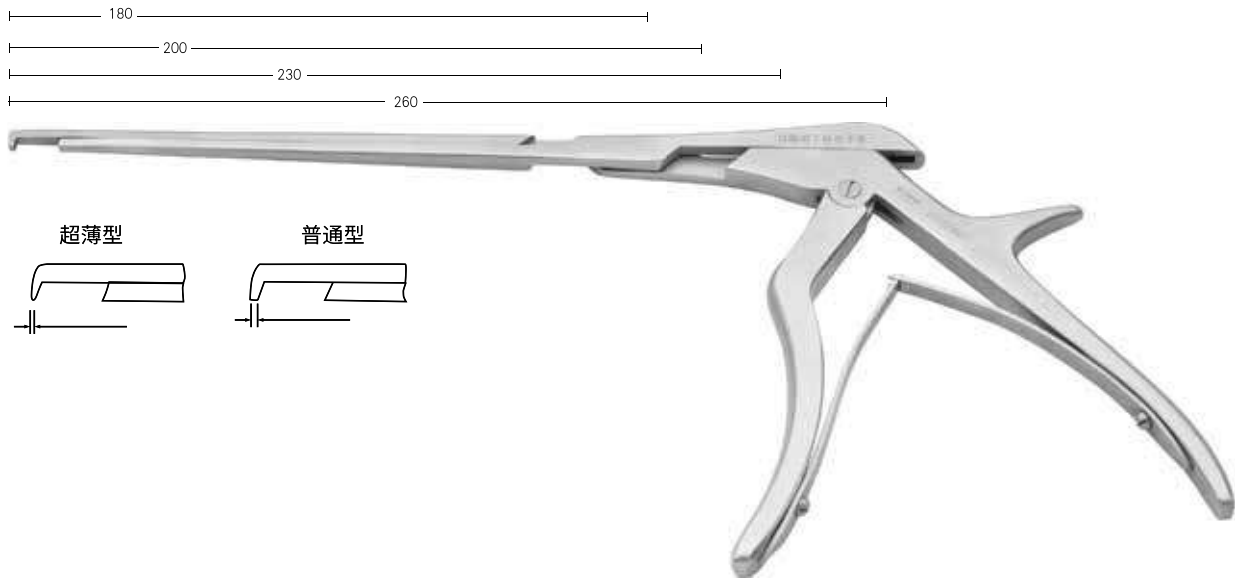

反扣式椎板咬骨钳  
Kerrison Punch downward cutting

- ZF491RN** 180x2/10x90°, 超薄型
- ZF494RN** 200x2/10x90°, 超薄型
- ZF497RN** 230x2/10x90°, 超薄型
- ZF492RN** 180x3/10x90°, 超薄型
- ZF495RN** 200x3/10x90°, 超薄型
- ZF498RN** 230x3/10x90°, 超薄型
- ZF493RN** 180x4/10x90°, 超薄型
- ZF496RN** 200x4/10x90°, 超薄型
- ZF499RN** 230x4/10x90°, 超薄型
- ZF527RN** 180x5/10x90°, 超薄型
- ZF528RN** 200x5/10x90°, 超薄型
- ZF529RN** 230x5/10x90°, 超薄型
- ZF500RN** 180x2/10x110°, 超薄型
- ZF503RN** 200x2/10x110°, 超薄型
- ZF506RN** 230x2/10x110°, 超薄型
- ZF501RN** 180x3/10x110°, 超薄型
- ZF504RN** 200x3/10x110°, 超薄型
- ZF507RN** 230x3/10x110°, 超薄型
- ZF502RN** 180x4/10x110°, 超薄型
- ZF505RN** 200x4/10x110°, 超薄型
- ZF508RN** 230x4/10x110°, 超薄型
- ZF530RN** 180x5/10x110°, 超薄型
- ZF531RN** 200x5/10x110°, 超薄型
- ZF532RN** 230x5/10x110°, 超薄型
- ZF509RN** 180x2/10x130°, 超薄型
- ZF512RN** 200x2/10x130°, 超薄型
- ZF515RN** 230x2/10x130°, 超薄型
- ZF510RN** 180x3/10x130°, 超薄型
- ZF513RN** 200x3/10x130°, 超薄型

- ZF516RN** 230x3/10x130°, 超薄型
- ZF511RN** 180x4/10x130°, 超薄型
- ZF514RN** 200x4/10x130°, 超薄型
- ZF517RN** 230x4/10x130°, 超薄型
- ZF533RN** 180x5/10x130°, 超薄型
- ZF534RN** 200x5/10x130°, 超薄型
- ZF535RN** 230x5/10x130°, 超薄型
- ZF791RN** 180x2/10x90°, 普通型
- ZF725RN** 200x2/10x90°, 普通型
- ZF728RN** 230x2/10x90°, 普通型
- ZF792RN** 180x3/10x90°, 普通型
- ZF726RN** 200x3/10x90°, 普通型
- ZF729RN** 230x3/10x90°, 普通型
- ZF793RN** 180x4/10x90°, 普通型
- ZF727RN** 200x4/10x90°, 普通型
- ZF730RN** 230x4/10x90°, 普通型
- ZF518RN** 180x5/10x90°, 普通型
- ZF519RN** 200x5/10x90°, 普通型
- ZF520RN** 230x5/10x90°, 普通型
- ZF731RN** 180x2/10x110°, 普通型
- ZF734RN** 200x2/10x110°, 普通型
- ZF737RN** 230x2/10x110°, 普通型
- ZF732RN** 180x3/10x110°, 普通型
- ZF735RN** 200x3/10x110°, 普通型
- ZF738RN** 230x3/10x110°, 普通型
- ZF733RN** 180x4/10x110°, 普通型
- ZF736RN** 200x4/10x110°, 普通型
- ZF739RN** 230x4/10x110°, 普通型
- ZF521RN** 180x5/10x110°, 普通型

- ZF522RN** 200x5/10x110°, 普通型
- ZF523RN** 230x5/10x110°, 普通型
- ZF740RN** 180x2/10x130°, 普通型
- ZF743RN** 200x2/10x130°, 普通型
- ZF746RN** 230x2/10x130°, 普通型
- ZF741RN** 180x3/10x130°, 普通型
- ZF744RN** 200x3/10x130°, 普通型
- ZF747RN** 230x3/10x130°, 普通型
- ZF742RN** 180x4/10x130°, 普通型
- ZF745RN** 200x4/10x130°, 普通型
- ZF794RN** 230x4/10x130°, 普通型
- ZF524RN** 180x5/10x130°, 普通型
- ZF525RN** 200x5/10x130°, 普通型
- ZF526RN** 230x5/10x130°, 普通型

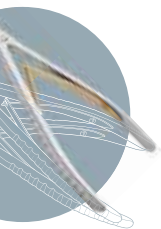



弧形椎板咬骨钳  
Kerrison Punch



- ZF1662Rd 180x2x90°, 普通型
- ZF1668Rd 180x3x90°, 普通型
- ZF1674Rd 180x4x90°, 普通型
- ZF1680Rd 180x5x90°, 普通型
- ZF1664Rd 180x2x110°, 普通型
- ZF1670Rd 180x3x110°, 普通型
- ZF1676Rd 180x4x110°, 普通型
- ZF1682Rd 180x5x110°, 普通型

- ZF1666Rd 180x2x130°, 普通型
- ZF1672Rd 180x3x130°, 普通型
- ZF1678Rd 180x4x130°, 普通型
- ZF1684Rd 180x5x130°, 普通型
- ZF1663Rd 180x2x90°, 超薄型
- ZF1669Rd 180x3x90°, 超薄型
- ZF1675Rd 180x4x90°, 超薄型
- ZF1681Rd 180x5x90°, 超薄型

- ZF1665Rd 180x2x110°, 超薄型
- ZF1671Rd 180x3x110°, 超薄型
- ZF1677Rd 180x4x110°, 超薄型
- ZF1683Rd 180x5x110°, 超薄型
- ZF1667Rd 180x2x130°, 超薄型
- ZF1673Rd 180x3x130°, 超薄型
- ZF1679Rd 180x4x130°, 超薄型
- ZF1685Rd 180x5x130°, 超薄型

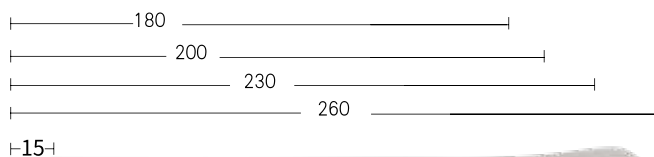
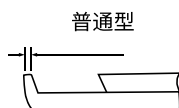

大开口椎板咬骨钳  
Kerrison Punch

- ZF1686RN 180x2/15x90°, 普通型
- ZF1690RN 200x2/15x90°, 普通型
- ZF1694RN 230x2/15x90°, 普通型
- ZF1698RN 260x2/15x90°, 普通型
- ZF1687RN 180x3/15x90°, 普通型
- ZF1691RN 200x3/15x90°, 普通型
- ZF1695RN 230x3/15x90°, 普通型
- ZF1699RN 260x3/15x90°, 普通型
- ZF1688RN 180x4/15x90°, 普通型
- ZF1692RN 200x4/15x90°, 普通型
- ZF1696RN 230x4/15x90°, 普通型
- ZF1700RN 260x4/15x90°, 普通型
- ZF1689RN 180x5/15x90°, 普通型
- ZF1693RN 200x5/15x90°, 普通型
- ZF1697RN 230x5/15x90°, 普通型
- ZF1701RN 260x5/15x90°, 普通型

- ZF1702RN 180x2/15x110°, 普通型
- ZF1706RN 200x2/15x110°, 普通型
- ZF1710RN 230x2/15x110°, 普通型
- ZF1714RN 260x2/15x110°, 普通型
- ZF1703RN 180x3/15x110°, 普通型
- ZF1707RN 200x3/15x110°, 普通型
- ZF1711RN 230x3/15x110°, 普通型
- ZF1715RN 260x3/15x110°, 普通型
- ZF1704RN 180x4/15x110°, 普通型
- ZF1708RN 200x4/15x110°, 普通型
- ZF1712RN 230x4/15x110°, 普通型
- ZF1716RN 260x4/15x110°, 普通型
- ZF1705RN 180x5/15x110°, 普通型
- ZF1709RN 200x5/15x110°, 普通型
- ZF1713RN 230x5/15x110°, 普通型
- ZF1717RN 260x5/15x110°, 普通型

- ZF1718RN 180x2/15x130°, 普通型
- ZF1722RN 200x2/15x130°, 普通型
- ZF1726RN 230x2/15x130°, 普通型
- ZF1730RN 260x2/15x130°, 普通型
- ZF1719RN 180x3/15x130°, 普通型
- ZF1723RN 200x3/15x130°, 普通型
- ZF1727RN 230x3/15x130°, 普通型
- ZF1731RN 260x3/15x130°, 普通型
- ZF1720RN 180x4/15x130°, 普通型
- ZF1724RN 200x4/15x130°, 普通型
- ZF1728RN 230x4/15x130°, 普通型
- ZF1732RN 260x4/15x130°, 普通型
- ZF1721RN 180x5/15x130°, 普通型
- ZF1725RN 200x5/15x130°, 普通型
- ZF1729RN 230x5/15x130°, 普通型
- ZF1733RN 260x5/15x130°, 普通型

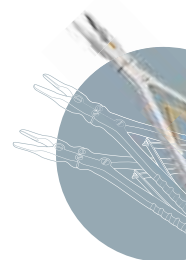

矫形外科(骨科)  
Orthopaedic Instruments

椎板咬骨钳  
Kerrison Punch, upward curved



ZF2576RNdh 180x4/10x130°, 超硬膜, 超薄型, 上弯  
ZF2575RNdh 180x3/10x130°, 超硬膜, 超薄型, 上弯  
ZF2574RNdh 180x2/10x130°, 超硬膜, 超薄型, 上弯

椎板咬骨钳  
Kerrison Punch, left curved



ZF2584RNdh 180x4/10x130°, 超硬膜, 超薄型, 左弯  
ZF2583RNdh 180x3/10x130°, 超硬膜, 超薄型, 左弯  
ZF2582RNdh 180x2/10x130°, 超硬膜, 超薄型, 左弯

椎板咬骨钳  
Kerrison Punch, right curved



ZF2592RNdh 180x4/10x130°, 超硬膜, 超薄型, 右弯  
ZF2591RNdh 180x3/10x130°, 超硬膜, 超薄型, 右弯  
ZF2590RNdh 180x2/10x130°, 超硬膜, 超薄型, 右弯

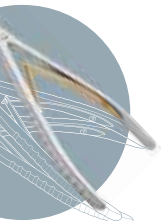

Orthopaedic Instruments  
矫形外科(骨科)

髓核钳 (指圈式)  
Laminectomy Rongeur



- |           |          |           |               |           |               |
|-----------|----------|-----------|---------------|-----------|---------------|
| ZF825RG   | 160x2x10 | ZF889RG   | 200x5x10      | ZF808RG   | 180x4x10x150° |
| ZF826RG   | 160x3x10 | ★ ZF890RG | 220x2x10      | ZF809RG   | 180x5x10x150° |
| ZF827RG   | 160x4x10 | ★ ZF834RG | 220x3x10      | ZF839RG   | 200x2x10x150° |
| ZF847RG   | 160x5x10 | ★ ZF823RG | 220x4x10      | ★ ZF979RG | 200x3x10x150° |
| ★ ZF821RG | 180x2x10 | ★ ZF861RG | 220x5x10      | ZF980RG   | 200x4x10x150° |
| ★ ZF805RG | 180x3x10 | ZF835RG   | 160x2x10x150° | ZF981RG   | 200x5x10x150° |
| ★ ZF806RG | 180x4x10 | ZF836RG   | 160x3x10x150° | ★ ZF982RG | 220x2x10x150° |
| ZF824RG   | 180x5x10 | ZF837RG   | 160x4x10x150° | ★ ZF983RG | 220x3x10x150° |
| ★ ZF848RG | 200x2x10 | ZF838RG   | 160x5x10x150° | ★ ZF984RG | 220x4x10x150° |
| ★ ZF849RG | 200x3x10 | ZF822RG   | 180x2x10x150° | ★ ZF985RG | 220x5x10x150° |
| ★ ZF888RG | 200x4x10 | ZF807RG   | 180x3x10x150° |           |               |

髓核钳 (指圈式)  
Laminectomy Rongeur



- |          |              |            |                   |          |                   |
|----------|--------------|------------|-------------------|----------|-------------------|
| ZF1747RG | 220x2x10, 有齿 | ZF1750RG   | 220x5x10, 有齿      | ZF1753RG | 220x4x10x150°, 有齿 |
| ZF1748RG | 220x3x10, 有齿 | ZF1751RG   | 220x2x10x150°, 有齿 | ZF1754RG | 220x5x10x150°, 有齿 |
| ZF1749RG | 220x4x10, 有齿 | ★ ZF1752RG | 220x3x10x150°, 有齿 |          |                   |

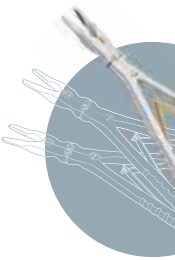

矫形外科(骨科)  
Orthopaedic Instruments



髓核钳  
Laminectomy Rongeur

- |          |                    |           |                      |           |                      |
|----------|--------------------|-----------|----------------------|-----------|----------------------|
| ZF567Rd  | 160×2×6, 握柄式       | ★ZF594Rd  | 220×4×10×150°, 握柄式   | ZF2520Rd  | 160×4.5×12×150°, 握柄式 |
| ★ZF568Rd | 180×2×6, 握柄式       | ZF595Rd   | 160×5×12×150°, 握柄式   | ZF2513Rd  | 180×2.5×8×150°, 握柄式  |
| ★ZF569Rd | 200×2×6, 握柄式       | ZF596Rd   | 180×5×12×150°, 握柄式   | ZF2517Rd  | 180×3.5×10×150°, 握柄式 |
| ★ZF570Rd | 220×2×6, 握柄式       | ★ZF597Rd  | 200×5×12×150°, 握柄式   | ZF2521Rd  | 180×4.5×12×150°, 握柄式 |
| ★ZF571Rd | 160×3×8, 握柄式       | ★ZF659Rd  | 220×5×12×150°, 握柄式   | ZF2514Rd  | 200×2.5×8×150°, 握柄式  |
| ★ZF572Rd | 180×3×8, 握柄式       | ★ZF1735Rd | 260×2×6, 握柄式         | ZF2518Rd  | 200×3.5×10×150°, 握柄式 |
| ★ZF573Rd | 200×3×8, 握柄式       | ★ZF1736Rd | 260×3×8, 握柄式         | ZF2522Rd  | 200×4.5×12×150°, 握柄式 |
| ★ZF574Rd | 220×3×8, 握柄式       | ★ZF1737Rd | 260×4×10, 握柄式        | ZF2515Rd  | 220×2.5×8×150°, 握柄式  |
| ZF575Rd  | 160×4×10, 握柄式      | ZF1738Rd  | 260×5×12, 握柄式        | ZF2519Rd  | 220×3.5×10×150°, 握柄式 |
| ★ZF576Rd | 180×4×10, 握柄式      | ZF1739Rd  | 260×2×6×150°, 握柄式    | ZF2523Rd  | 220×4.5×12×150°, 握柄式 |
| ★ZF577Rd | 200×4×10, 握柄式      | ZF1740Rd  | 260×3×8×150°, 握柄式    | ZF1778Rd  | 260×2.5×8, 握柄式       |
| ★ZF578Rd | 220×4×10, 握柄式      | ZF665Rd   | 260×4×10×150°, 握柄式   | ZF1779Rd  | 260×3.5×10, 握柄式      |
| ZF579Rd  | 160×5×12, 握柄式      | ZF1741Rd  | 260×5×12×150°, 握柄式   | ZF1780Rd  | 260×4.5×12, 握柄式      |
| ZF580Rd  | 180×5×12, 握柄式      | ZF2500Rd  | 160×2.5×8, 握柄式       | ZF1782Rd  | 260×2.5×8×150°, 握柄式  |
| ★ZF581Rd | 200×5×12, 握柄式      | ★ZF2504Rd | 160×3.5×10, 握柄式      | ★ZF1783Rd | 260×3.5×10×150°, 握柄式 |
| ★ZF582Rd | 220×5×12, 握柄式      | ★ZF2508Rd | 160×4.5×12, 握柄式      | ZF1784Rd  | 260×4.5×12×150°, 握柄式 |
| ZF583Rd  | 160×2×6×150°, 握柄式  | ZF2501Rd  | 180×2.5×8, 握柄式       |           |                      |
| ZF584Rd  | 180×2×6×150°, 握柄式  | ★ZF2505Rd | 180×3.5×10, 握柄式      |           |                      |
| ★ZF585Rd | 200×2×6×150°, 握柄式  | ZF2509Rd  | 180×4.5×12, 握柄式      |           |                      |
| ★ZF586Rd | 220×2×6×150°, 握柄式  | ★ZF2502Rd | 200×2.5×8, 握柄式       |           |                      |
| ZF587Rd  | 160×3×8×150°, 握柄式  | ZF2506Rd  | 200×3.5×10, 握柄式      |           |                      |
| ZF588Rd  | 180×3×8×150°, 握柄式  | ★ZF2510Rd | 200×4.5×12, 握柄式      |           |                      |
| ★ZF589Rd | 200×3×8×150°, 握柄式  | ZF2503Rd  | 220×2.5×8, 握柄式       |           |                      |
| ★ZF590Rd | 220×3×8×150°, 握柄式  | ★ZF2507Rd | 220×3.5×10, 握柄式      |           |                      |
| ZF591Rd  | 160×4×10×150°, 握柄式 | ★ZF2511Rd | 220×4.5×12, 握柄式      |           |                      |
| ZF592Rd  | 180×4×10×150°, 握柄式 | ★ZF2512Rd | 160×2.5×8×150°, 握柄式  |           |                      |
| ★ZF593Rd | 200×4×10×150°, 握柄式 | ZF2516Rd  | 160×3.5×10×150°, 握柄式 |           |                      |

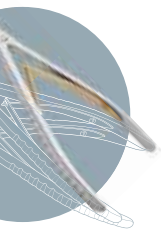



髓核钳  
Laminectomy Rongeur

ZF567RNdH	160×2×6, 握柄式, 超硬膜	ZF1740RNdH	260×3×8×150°, 握柄式, 超硬膜
★ZF568RNdH	180×2×6, 握柄式, 超硬膜	ZF665RNdH	260×4×10×150°, 握柄式, 超硬膜
★ZF569RNdH	200×2×6, 握柄式, 超硬膜	ZF1741RNdH	260×5×12×150°, 握柄式, 超硬膜
★ZF570RNdH	220×2×6, 握柄式, 超硬膜	ZF2500RNdH	160×2.5×8, 握柄式, 超硬膜
ZF571RNdH	160×3×8, 握柄式, 超硬膜	ZF2504RNdH	160×3.5×10, 握柄式, 超硬膜
★ZF572RNdH	180×3×8, 握柄式, 超硬膜	ZF2508RNdH	160×4.5×12, 握柄式, 超硬膜
★ZF573RNdH	200×3×8, 握柄式, 超硬膜	ZF2501RNdH	180×2.5×8, 握柄式, 超硬膜
★ZF574RNdH	220×3×8, 握柄式, 超硬膜	ZF2505RNdH	180×3.5×10, 握柄式, 超硬膜
ZF575RNdH	160×4×10, 握柄式, 超硬膜	ZF2509RNdH	180×4.5×12, 握柄式, 超硬膜
ZF576RNdH	180×4×10, 握柄式, 超硬膜	ZF2502RNdH	200×2.5×8, 握柄式, 超硬膜
★ZF577RNdH	200×4×10, 握柄式, 超硬膜	ZF2506RNdH	200×3.5×10, 握柄式, 超硬膜
★ZF578RNdH	220×4×10, 握柄式, 超硬膜	ZF2510RNdH	200×4.5×12, 握柄式, 超硬膜
ZF579RNdH	160×5×12, 握柄式, 超硬膜	ZF2503RNdH	220×2.5×8, 握柄式, 超硬膜
ZF580RNdH	180×5×12, 握柄式, 超硬膜	ZF2507RNdH	220×3.5×10, 握柄式, 超硬膜
ZF581RNdH	200×5×12, 握柄式, 超硬膜	ZF2511RNdH	220×4.5×12, 握柄式, 超硬膜
★ZF582RNdH	220×5×12, 握柄式, 超硬膜	ZF2512RNdH	160×2.5×8×150°, 握柄式, 超硬膜
ZF583RNdH	160×2×6×150°, 握柄式, 超硬膜	ZF2516RNdH	160×3.5×10×150°, 握柄式, 超硬膜
ZF584RNdH	180×2×6×150°, 握柄式, 超硬膜	ZF2520RNdH	160×4.5×12×150°, 握柄式, 超硬膜
ZF585RNdH	200×2×6×150°, 握柄式, 超硬膜	ZF2513RNdH	180×2.5×8×150°, 握柄式, 超硬膜
★ZF586RNdH	220×2×6×150°, 握柄式, 超硬膜	ZF2517RNdH	180×3.5×10×150°, 握柄式, 超硬膜
ZF587RNdH	160×3×8×150°, 握柄式, 超硬膜	ZF2521RNdH	180×4.5×12×150°, 握柄式, 超硬膜
ZF588RNdH	180×3×8×150°, 握柄式, 超硬膜	ZF2514RNdH	200×2.5×8×150°, 握柄式, 超硬膜
★ZF589RNdH	200×3×8×150°, 握柄式, 超硬膜	ZF2518RNdH	200×3.5×10×150°, 握柄式, 超硬膜
★ZF590RNdH	220×3×8×150°, 握柄式, 超硬膜	ZF2522RNdH	200×4.5×12×150°, 握柄式, 超硬膜
ZF591RNdH	160×4×10×150°, 握柄式, 超硬膜	ZF2515RNdH	220×2.5×8×150°, 握柄式, 超硬膜
ZF592RNdH	180×4×10×150°, 握柄式, 超硬膜	ZF2519RNdH	220×3.5×10×150°, 握柄式, 超硬膜
ZF593RNdH	200×4×10×150°, 握柄式, 超硬膜	ZF2523RNdH	220×4.5×12×150°, 握柄式, 超硬膜
★ZF594RNdH	220×4×10×150°, 握柄式, 超硬膜	ZF1778RNdH	260×2.5×8, 握柄式, 超硬膜
ZF595RNdH	160×5×12×150°, 握柄式, 超硬膜	ZF1779RNdH	260×3.5×10, 握柄式, 超硬膜
ZF596RNdH	180×5×12×150°, 握柄式, 超硬膜	ZF1780RNdH	260×4.5×12, 握柄式, 超硬膜
ZF597RNdH	200×5×12×150°, 握柄式, 超硬膜	ZF1782RNdH	260×2.5×8×150°, 握柄式, 超硬膜
ZF659RNdH	220×5×12×150°, 握柄式, 超硬膜	ZF1783RNdH	260×3.5×10×150°, 握柄式, 超硬膜
★ZF1735RNdH	260×2×6, 握柄式, 超硬膜	ZF1784RNdH	260×4.5×12×150°, 握柄式, 超硬膜
★ZF1736RNdH	260×3×8, 握柄式, 超硬膜		
★ZF1737RNdH	260×4×10, 握柄式, 超硬膜		
ZF1738RNdH	260×5×12, 握柄式, 超硬膜		
ZF1739RNdH	260×2×6×150°, 握柄式, 超硬膜		

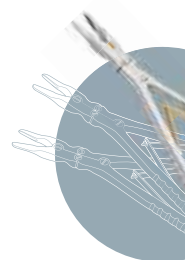

矫形外科(骨科)  
Orthopaedic Instruments

弧形髓核钳  
 Laminectomy Rongeur



**ZF1742Rd** 260x2x6, 握柄式  
**ZF1743Rd** 260x3x8, 握柄式

★ **ZF666Rd** 260x4x10, 握柄式  
**ZF1744Rd** 260x5x12, 握柄式

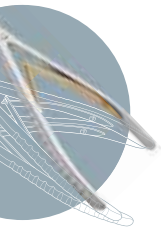

髓核钳  
 Laminectomy Rongeur



**ZF1757Rd** 220x2x6, 握柄式, 有齿  
 ★ **ZF1758Rd** 220x3x8, 握柄式, 有齿  
 ★ **ZF1759Rd** 220x4x10, 握柄式, 有齿  
**ZF1760Rd** 220x5x12, 握柄式, 有齿  
**ZF1761Rd** 220x2x6x150°, 握柄式, 有齿  
 ★ **ZF1762Rd** 220x3x8x150°, 握柄式, 有齿  
**ZF1763Rd** 220x4x10x150°, 握柄式, 有齿  
**ZF1764R** 220x5x12x150°, 握柄式, 有齿

**ZF1767Rd** 260x2x6, 握柄式, 有齿  
**ZF1768Rd** 260x3x8, 握柄式, 有齿  
**ZF1769Rd** 260x4x10, 握柄式, 有齿  
**ZF1770Rd** 260x5x12, 握柄式, 有齿  
**ZF1771Rd** 260x2x6x150°, 握柄式, 有齿  
**ZF1772Rd** 260x3x8x150°, 握柄式, 有齿  
**ZF1773Rd** 260x4x10x150°, 握柄式, 有齿  
**ZF1774Rd** 260x5x12x150°, 握柄式, 有齿

一体型椎间盘铰刀  
 Reamer

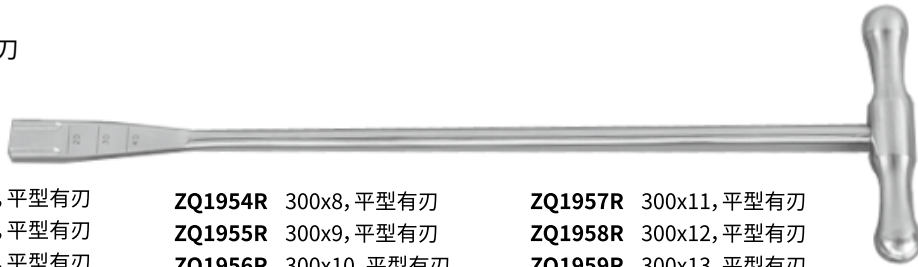

- |                            |                             |                             |
|----------------------------|-----------------------------|-----------------------------|
| <b>ZQ1950R</b> 300x4, 平型有刃 | <b>ZQ1954R</b> 300x8, 平型有刃  | <b>ZQ1957R</b> 300x11, 平型有刃 |
| <b>ZQ1951R</b> 300x5, 平型有刃 | <b>ZQ1955R</b> 300x9, 平型有刃  | <b>ZQ1958R</b> 300x12, 平型有刃 |
| <b>ZQ1952R</b> 300x6, 平型有刃 | <b>ZQ1956R</b> 300x10, 平型有刃 | <b>ZQ1959R</b> 300x13, 平型有刃 |
| <b>ZQ1953R</b> 300x7, 平型有刃 |                             |                             |

一体型椎间盘铰刀  
 Reamer

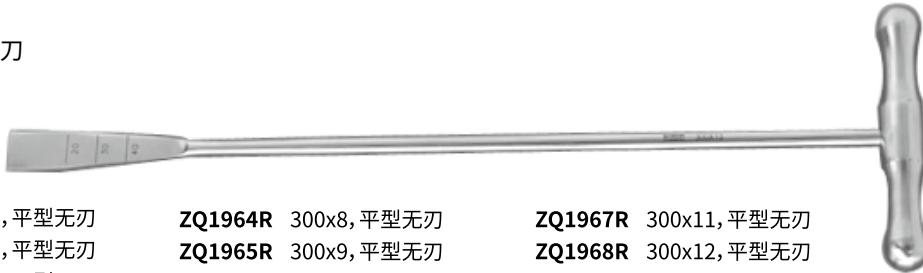

- |                            |                             |                             |
|----------------------------|-----------------------------|-----------------------------|
| <b>ZQ1960R</b> 300x4, 平型无刃 | <b>ZQ1964R</b> 300x8, 平型无刃  | <b>ZQ1967R</b> 300x11, 平型无刃 |
| <b>ZQ1961R</b> 300x5, 平型无刃 | <b>ZQ1965R</b> 300x9, 平型无刃  | <b>ZQ1968R</b> 300x12, 平型无刃 |
| <b>ZQ1962R</b> 300x6, 平型无刃 | <b>ZQ1966R</b> 300x10, 平型无刃 | <b>ZQ1969R</b> 300x13, 平型无刃 |
| <b>ZQ1963R</b> 300x7, 平型无刃 |                             |                             |

一体型椎间盘铰刀  
 Reamer



- |                                 |                                  |                                  |
|---------------------------------|----------------------------------|----------------------------------|
| <b>ZQ1970R</b> 300x4, 平型有刃, 带圆角 | <b>ZQ1974R</b> 300x8, 平型有刃, 带圆角  | <b>ZQ1977R</b> 300x11, 平型有刃, 带圆角 |
| <b>ZQ1971R</b> 300x5, 平型有刃, 带圆角 | <b>ZQ1975R</b> 300x9, 平型有刃, 带圆角  | <b>ZQ1978R</b> 300x12, 平型有刃, 带圆角 |
| <b>ZQ1972R</b> 300x6, 平型有刃, 带圆角 | <b>ZQ1976R</b> 300x10, 平型有刃, 带圆角 | <b>ZQ1979R</b> 300x13, 平型有刃, 带圆角 |
| <b>ZQ1973R</b> 300x7, 平型有刃, 带圆角 |                                  |                                  |

一体型椎间盘铰刀  
 Reamer



- |                           |
|---------------------------|
| <b>ZQ1980R</b> 300x9, 圆型  |
| <b>ZQ1981R</b> 300x11, 圆型 |
| <b>ZQ1982R</b> 300x13, 圆型 |

椎间盘铰刀手柄  
 Reamer



- |                        |
|------------------------|
| <b>ZQ1983R</b> 椎间盘铰刀手柄 |
|------------------------|

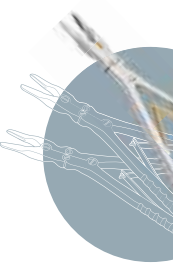

矫形外科(骨科)  
 Orthopaedic Instruments

分体型椎间盘铰刀  
Reamer



**ZQ1984R** 220x4, 平型有刃  
**ZQ1985R** 220x5, 平型有刃  
**ZQ1986R** 220x6, 平型有刃  
**ZQ1987R** 220x7, 平型有刃

**ZQ1988R** 220x8, 平型有刃  
**ZQ1989R** 220x9, 平型有刃  
**ZQ1990R** 220x10, 平型有刃

**ZQ1991R** 220x11, 平型有刃  
**ZQ1992R** 220x12, 平型有刃  
**ZQ1993R** 220x13, 平型有刃

分体型椎间盘铰刀  
Reamer



**ZQ1994R** 220x4, 平型无刃  
**ZQ1995R** 220x5, 平型无刃  
**ZQ1996R** 220x6, 平型无刃  
**ZQ1997R** 220x7, 平型无刃

**ZQ1998R** 220x8, 平型无刃  
**ZQ1999R** 220x9, 平型无刃  
**ZQ2000R** 220x10, 平型无刃

**ZQ2001R** 220x11, 平型无刃  
**ZQ2002R** 220x12, 平型无刃  
**ZQ2003R** 220x13, 平型无刃

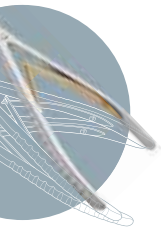

矫形外科  
(骨科)  
Orthopaedic Instruments

分体型椎间盘铰刀  
Reamer



**ZQ2004R** 220x4, 平型有刃, 带圆角  
**ZQ2005R** 220x5, 平型有刃, 带圆角  
**ZQ2006R** 220x6, 平型有刃, 带圆角  
**ZQ2007R** 220x7, 平型有刃, 带圆角  
**ZQ2008R** 220x8, 平型有刃, 带圆角

**ZQ2009R** 220x9, 平型有刃, 带圆角  
**ZQ2010R** 220x10, 平型有刃, 带圆角  
**ZQ2011R** 220x11, 平型有刃, 带圆角  
**ZQ2012R** 220x12, 平型有刃, 带圆角  
**ZQ2013R** 220x13, 平型有刃, 带圆角

分体型椎间盘铰刀  
Reamer



**ZQ2014R** 220x9, 圆型  
**ZQ2015R** 220x11, 圆型

**ZQ2016R** 220x13, 圆型



骨把持器 (骨折固定夹)  
Bone Clamp



★ ZK190R 小 150

★ ZK191R 中 183

★ ZK192R 大 215

带尖复位钳  
Reposition Forceps



★ ZK165R 190

★ ZK166R 210

★ ZK232R 260

★ ZK186R 155

复位钳  
Reposition Forceps



★ ZK164R 170

★ ZK163R 230

三爪复位钳  
Reposition Forceps



★ ZK169R 200

ZK180R 190

骨科复位钳  
Reposition Forceps



★ ZK233R 400

★ ZK234R 440

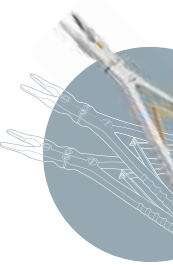

矫形外科(骨科)  
Orthopaedic Instruments

骨科复位钳  
Reposition Forceps

★ ZK235R 390



弯头复位钳  
Reposition Forceps

★ ZK176R 240

★ ZK177R 270



直头复位钳  
Reposition Forceps

★ ZK178R 300



双爪复位钳  
Reposition Forceps

★ ZK173R 415



不对称双爪复位钳  
Reposition Forceps

★ ZK175R 415

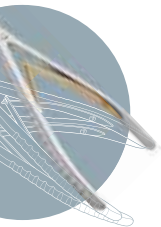

Orthopaedic Instruments  
矫形外科(骨科)

三爪复位钳  
Reposition Forceps

★ ZK174R 415



顶棒  
Rod

★ ZQ957R 300



髌臼复位钳  
Reposition Forceps

★ ZK179R 340, 撑开及压缩两用



椎体复位器  
Reposition Forceps

ZQ1534R 230x10x5°, 弯



胫骨平台复位器  
Reposition Forceps

★ ZQ1262R 200

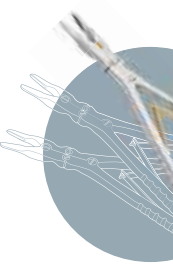

矫形外科(骨科)  
Orthopaedic Instruments

手指持骨钳  
Bone Clamp

★ ZK227R 170



侧弯持骨钳  
Bone Clamp

★ ZK228R 140



腕骨复位钳  
Wrist Reposition Forceps

ZK183RN 155, 弯

★ ZK184RN 185, 弯

注:孔 $\phi$ 1.6

Remark:Hole  $\phi$ 1.6



腕骨撑开钳  
Wrist Distractor

ZK185RN 185, 弯

注:孔 $\phi$ 1.6

Remark:Hole  $\phi$ 1.6

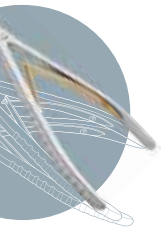

Orthopaedic Instruments  
矫形外科(骨科)

骨科复位钳  
Reposition Forceps  
★ ZK188RB 140, 指圈式



多齿持骨钳  
Bone Holding Forceps  
★ ZK158R 200, 带自锁



多齿持骨钳  
Bone Holding Forceps  
★ ZK159R 250, 带自锁



多齿持骨钳  
Bone Holding Forceps  
★ ZK141R 260

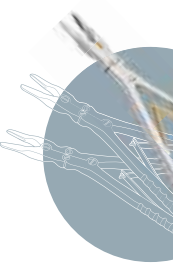

矫形外科(骨科)  
Orthopaedic Instruments

中心化持骨钳  
Self-Centering Forceps

- ★ ZK161R 190
- ★ ZK162R 270



三爪自定中心持骨钳  
Bone Holding Forceps

- ★ ZK226R 250



导向持骨钳  
Bone Holding Forceps

- ZK223R 小 small
- ★ ZK224R 中 medium
- ★ ZK225R 大 large



持骨钳  
Bone Clamp

- ★ ZK151R 四齿

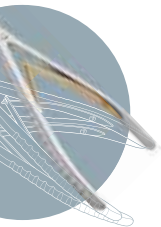

矫形外科(骨科)  
Orthopaedic Instruments

持骨钳  
Bone Clamp  
★ ZK137R 两齿



棘突打孔器  
Punch For Spinous Process  
★ ZK426R 小号 small  
★ ZK427R 大号 large



棘突打孔器  
Punch For Spinous Process  
★ ZK413R 220x25



骸骨钳  
Patella Forceps  
★ ZK170R 骸骨钳 190



软骨钳  
Cartilage Forceps  
★ ZQ1157R 200, 直 (半月板器械) Straight  
★ ZQ1158R 200, 弯 (半月板器械) Curved

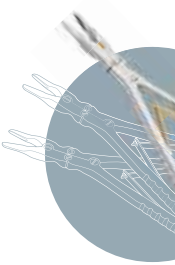

矫形外科(骨科)  
Orthopaedic Instruments

钢丝剪

Wire Cutting Scissors

- ★ **ZK470RG** 140, 指圈式, 钢丝 $\leq\phi 1.2$ , 钢针 $\leq\phi 0.8$   
for wire  $\leq \phi 1.2$ , for pin  $\leq \phi 0.8$



钢针剪

Wire Cutting Scissors

- ★ **ZK273R** 200x $\phi 1.2$



钢针剪

Wire Cutting Scissors

- ZK276R** 200x $\phi 2.5$
- ★ **ZK274R** 240x $\phi 2.5$

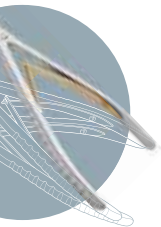

矫形外科(骨科)  
Orthopaedic Instruments



克氏剪  
KIRSCHNER Wire Cutting Scissors

★ ZK278R 205x $\phi$ 3.5, 圆头



钢针剪  
Wire Cutting Scissors

★ ZK475R 240x $\phi$ 2.5, 双面有刃



钢针剪  
Wire Cutting Scissors

ZK286RB 240x $\phi$ 3, 双关节

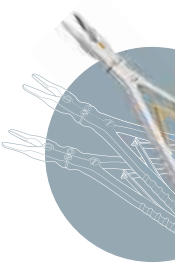

矫形外科(骨科)  
Orthopaedic Instruments

钢丝剪  
Wire Cutting Scissors

★ ZK283R/RN 215x $\phi$ 2.5, 双关节



钢丝剪  
Wire Cutting Scissors

★ LS719R 500, 剪 $\phi$ 6以下钢针 Cutting Rang: Less Than  $\phi$ 6  
★ ZK275R 350x ( $\phi$ 1- $\phi$ 4)



钢丝钳  
Wire Cutting Forceps

★ ZK500R 170 剪切范围 $\phi$ 0.2-1.5钢丝  
cutting range:  $\phi$ 0.2-1.5 wire



钢丝钳  
Wire Cutting Forceps

★ ZK261R 180 斜口 剪切范围 $\leq \phi$ 2  
cutting range  $\leq \phi$ 0.2

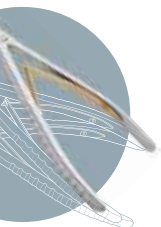

矫形外科(骨科)  
Orthopaedic Instruments

克氏钳  
KIRSCHNER Wire Cutting Forceps

★ ZK267R 200xΦ2, 尖头



克丝(氏)钳  
KIRSCHNER Wire Cutting Forceps

剪切范围Φ0.2—Φ1.5钢丝  
cutting range: Φ0.2-Φ1.5wire

★ ZK263R 160 尖嘴, 薄腮  
★ ZK264R 180 尖嘴, 薄腮



克氏钳  
KIRSCHNER Wire Cutting Forceps

★ ZK268R 200xΦ2, 虎头

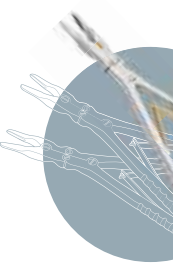

矫形外科(骨科)  
Orthopaedic Instruments

克氏钳  
KIRSCHNER Wire Cutting Forceps

★ ZK270R 210xΦ2, 虎头



克氏钳  
KIRSCHNER Wire Cutting Forceps

★ ZK282R 235xΦ2, 虎头



紧丝钳  
Wire Tightening Forceps

★ ZK271R 紧丝钳

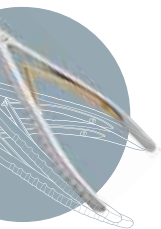

扎丝钳  
Wire Tightening Forceps

★ ZK272R 245



克氏钳  
KIRSCHNER Wire Cutting Forceps

★ ZK262R 180, 偏口, 钢丝 $\leq\phi 1.5$ , 钢针 $\leq\phi 1.2$   
for wire  $\leq\phi 1.5$ , for pin  $\leq\phi 1.2$



钢丝剪  
Wire Cutting Scissors

★ ZK280RB 28cm 双关节圆头交错刃, 钢针 $\leq\phi 3.5$   
for pin  $\leq\phi 3.5$

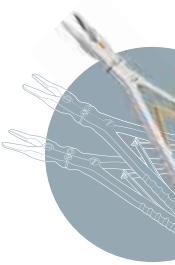

矫形外科(骨科)  
Orthopaedic Instruments

指骨挫  
 Bone File

- ★ ZK502R 190, 直 straight
- ★ ZK509R 190, 弯 curved



双头骨挫  
 Bone File

“#”越大, 纹路越细 bigger No. means finer serration.

- ZK448R 200, 1#
- ★ ZK449R 200, 2#
- ZK477R 200, 3#
- ★ ZK450R 200, 4#
- ★ ZK451R 200, 5#



单头骨挫  
 Bone File

“#”越大, 纹路越粗 bigger No. means coarser serration.

- ★ ZK452R 220, 1#
- ★ ZK453R 220, 2#
- ★ ZK454R 220, 3#



骨挫  
 Bone File

- ★ ZK511R 250



截断刀  
 Amputation Knife

- ★ ZB150R 300



指骨锯 (圆柄)  
 Bone Saw

- ★ ZK444R 180

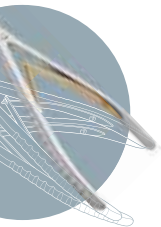

指骨锯 (扁柄)  
Bone Saw  
ZK445R 230



石膏锯  
Plaster Saw  
★ ZK446R 205



手部骨锯  
Hand Bone Saw  
★ ZA302R 210  
ZA303R 锯条 blade

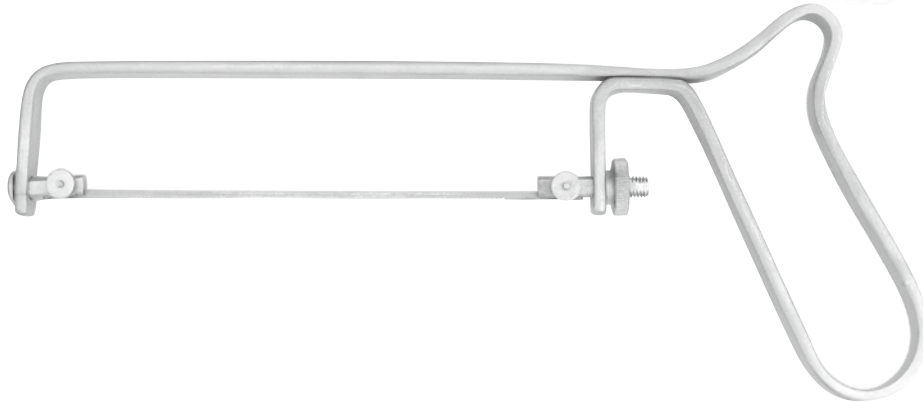

弓锯  
Bone Saw  
★ ZA300R 300  
ZA301C 锯条 blade



板型骨锯  
BoneSaw  
★ ZK447R 320

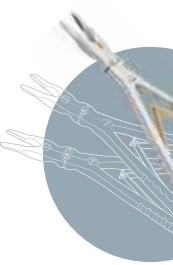

矫形外科(骨科)  
Orthopaedic Instruments

牵开拉钩  
Retractor

- ★ ZQ641R 160X5小,直
- ★ ZQ642R 160X10大,直



牵开拉钩  
Retractor

- ★ ZQ643R 140X2.5小,弯
- ★ ZQ644R 140X4大,弯



小儿骨撬  
Child Bone Lever

- ★ ZQ568R 2X1 (套) set  
150×20  
150×15



骨撬 (霍夫曼拉钩)  
Bone Lever

- ★ ZQ569R 150X6
- ★ ZQ570R 150X8
- ★ ZQ571R 150X10
- ★ ZQ572R 150X15

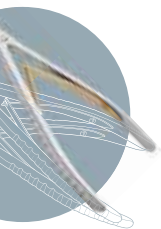

Orthopaedic Instruments  
矫形外科(骨科)



尖骨撬 (霍夫曼拉钩)  
Bone Lever

- ★ ZQ573R 240X10
- ★ ZQ574R 240X15
- ★ ZQ729R 240X20
- ★ ZQ575R 240X25
- ★ ZQ730R 240X30



尖骨撬 (霍夫曼拉钩)  
Bone Lever

- ★ ZQ576R 240X40



平骨撬 (霍夫曼拉钩)  
Bone Lever

- ★ ZQ577R 240X10
- ★ ZQ578R 240X15
- ★ ZQ773R 240X20
- ★ ZQ579R 240X25
- ★ ZQ774R 240X30
- ★ ZQ754R 240X18



平骨撬 (霍夫曼拉钩)  
Bone Lever

- ★ ZQ580R 240X42

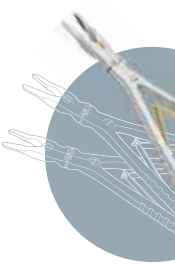

矫形外科(骨科)  
Orthopaedic Instruments

## 直接前入路 (DAA) 微创全髋置换骨撬 DAA Micro Bone Lever



骨撬  
Bone Lever  
ZT827R 350x25, 弯, 髋关节, 胶木柄



骨撬 (胶木柄)  
Bone Lever  
★ ZT545R 310x25, 弯, 双钩



骨撬  
Bone Lever  
ZT820R 335x30, 弯



骨撬  
Bone Lever  
ZT826R 270x20, 弯, 髋关节



骨撬  
Bone Lever  
ZT591R 270x27, 弯, 髋关节



骨撬  
Bone Lever  
★ ZT583R 285x16, 弯, 髋关节

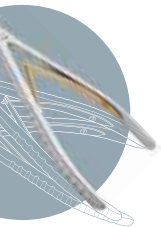

矫形外科 (骨科)  
Orthopaedic Instruments



骨撬  
Bone Lever  
★ **ZT575R** 260x38, 弯, 腕关节



骨撬  
Bone Lever  
**ZT803R** 330x23, 弯, 腕关节



骨撬  
Bone Lever  
★ **ZT567R** 300x46, 弯, 腕关节



骨撬  
Bone Lever  
**ZT571R** 300x19, 单钩, 腕关节

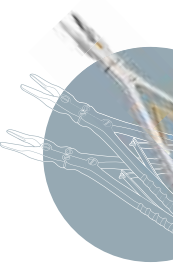

矫形外科(骨科)  
Orthopaedic Instruments

标准后侧入路小切口骨撬 (半髌置换)  
Hemiarthroplasty Bone Lever



骨撬  
Bone Lever

ZT807R 270x45, 弯, 髌关节(左)  
left



骨撬  
Bone Lever

ZT808R 270x45, 弯, 髌关节(右)  
right



骨撬  
Bone Lever

ZT809R 300x35, 弯, 髌关节



骨撬  
Bone Lever

★ ZT576R 315x35, 有齿, 髌关节



骨撬  
Bone Lever

★ ZT582R 255x23, 弯, 膝关节



骨撬  
Bone Lever

ZT804R 265x10, 弯

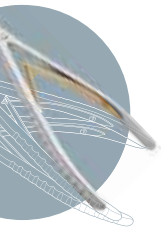

Orthopaedic Instruments  
矫形外科(骨科)



骨撬  
Bone Lever  
ZT821R 345x27, 弯



多齿骨撬  
Bone Lever  
★ ZQ585R 300



槽钩骨撬  
Bone Lever  
★ ZQ583R 260



骨撬  
Bone Lever  
ZT818R 233x20, 弯

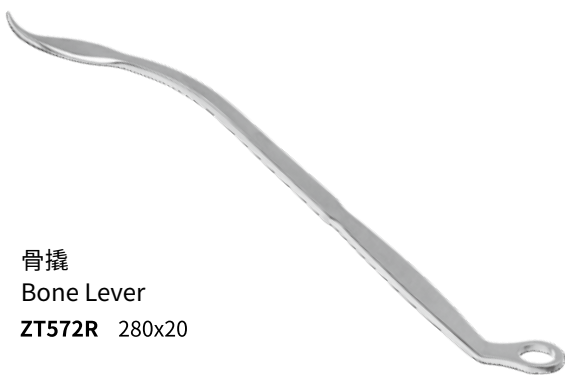

骨撬  
Bone Lever  
ZT572R 280x20

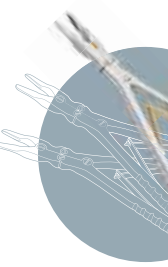

矫形外科(骨科)  
Orthopaedic Instruments

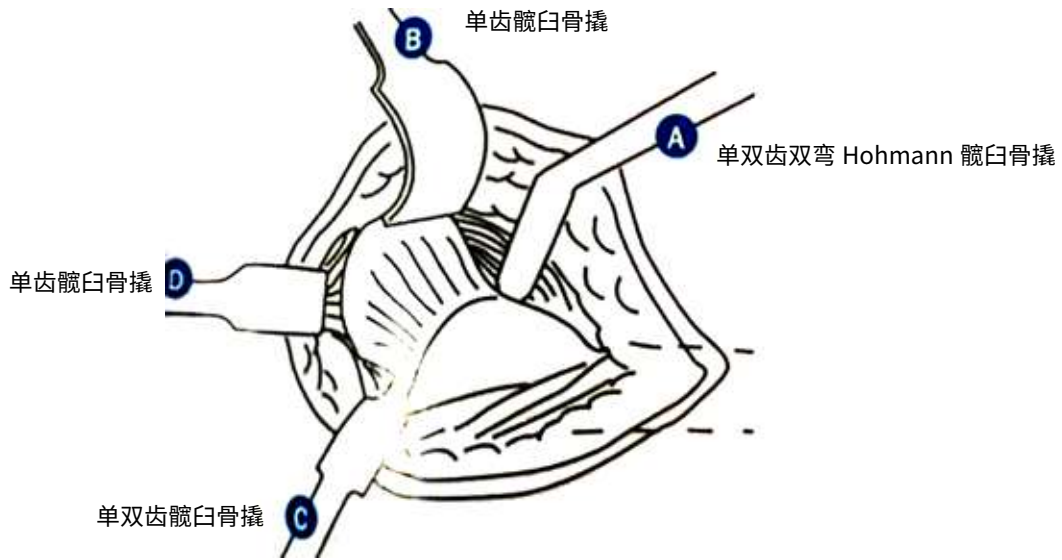

**A** 单双齿双弯 Hohmann 腕臼骨撬  
 Hoffmann Bone Lever

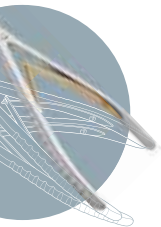

Orthopaedic Instruments  
 矫形外科(骨科)





骨撬  
Bone Lever  
★ ZT551R 230x3



骨撬  
Bone Lever  
★ ZT552R 235x3

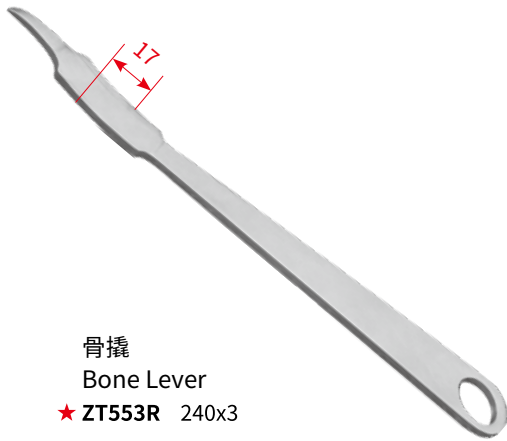

骨撬  
Bone Lever  
★ ZT553R 240x3



骨撬  
Bone Lever  
ZT811R 460x18, 弯, 髋关节  
ZT812R 360x18, 弯, 髋关节

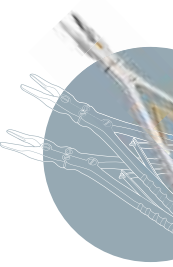

矫形外科(骨科)  
Orthopaedic Instruments

**B** 单齿髌臼骨撬  
Bone Lever



骨撬  
Bone Lever  
★ ZT574R 340x38, 单钩, 髌关节



骨撬  
Bone Lever  
★ ZT550R 325, 单钩



骨撬  
Bone Lever  
ZT825R 300x46, 弯, 髌关节



骨撬  
Bone Lever  
ZT589R 220x19, 弯, 髌关节



骨撬  
Bone Lever  
ZT592R 425x58, 有齿, 髌关节



骨撬  
Bone Lever  
ZT593R 425x34, 有齿, 髌关节

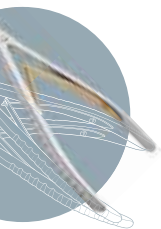

矫形外科 (骨科)  
Orthopaedic Instruments



◎ 单双齿髌臼骨撬  
Bone Lever



骨撬  
Bone Lever  
ZT813R 320x40, 弯, 髌关节



骨撬  
Bone Lever  
★ ZT561R 弯, 270x38



骨撬  
Bone Lever  
★ ZQ582R 280x28



骨撬  
Bone Lever  
ZT824R 300x28, 弯



骨撬  
Bone Lever  
ZT819R 300x28, 弯, 髌关节



骨撬  
Bone Lever  
★ ZT555R 280x3

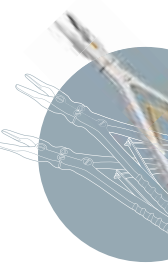

矫形外科(骨科)  
Orthopaedic Instruments



骨撬  
Bone Lever  
★ ZT558R 弯, 305x12



骨撬  
Bone Lever  
★ ZT559R 弯, 305x18

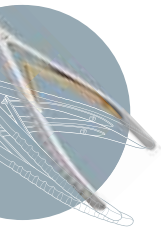

矫形外科  
(骨科)  
Orthopaedic Instruments



骨撬  
Bone Lever  
★ ZT560R 弯, 310x22

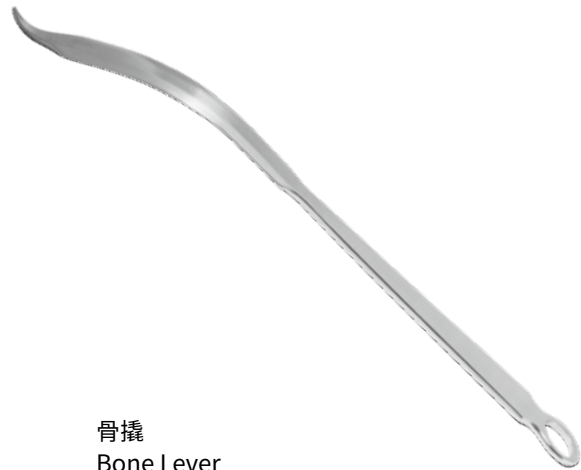

骨撬  
Bone Lever  
★ ZT590R 350x23, 弯, 髋关节



骨撬  
Bone Lever  
ZT570R 325x34, 弯, 髋关节



骨撬  
Bone Lever  
ZT588R 380x30, 双齿, 髋关节



骨撬  
Bone Lever

**ZT806R** 245x55, 弯, 髋关节



骨撬  
Bone Lever

★ **ZT562R** 带齿, 205x18



双齿骨撬  
Bone Lever

★ **ZQ584R** 300

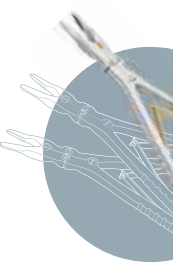

矫形外科(骨科)  
Orthopaedic Instruments

④ 单齿髁臼骨撬  
Bone Lever



骨撬  
Bone Lever  
★ ZQ581R 280X28



骨撬  
Bone Lever  
★ ZT546R 335x26, 弯

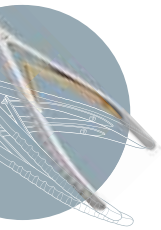

## 膝关节置换骨撬 TKA Bone Lever



骨撬  
Bone Lever  
ZT814R 250x35, 弯  
ZT815R 250x25, 弯



骨撬  
Bone Lever  
ZT586R 180x42, 弯, AORI腓骨拉钩



骨撬  
Bone Lever  
ZT584R 150x11, 弯, Z型膝关节拉钩

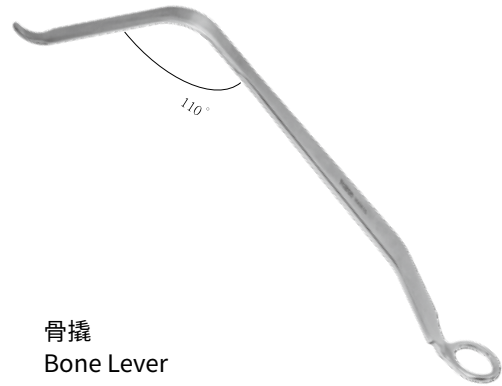

骨撬  
Bone Lever  
ZT816R 300x15, 弯



骨撬  
Bone Lever  
ZT817R 270x15, 弯



骨撬  
Bone Lever  
ZT585R 240x39, 尖头, 膝关节外侧脂肪垫拉钩

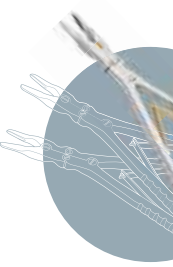

矫形外科(骨科)  
Orthopaedic Instruments

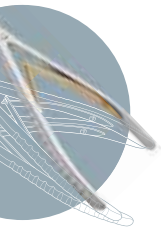
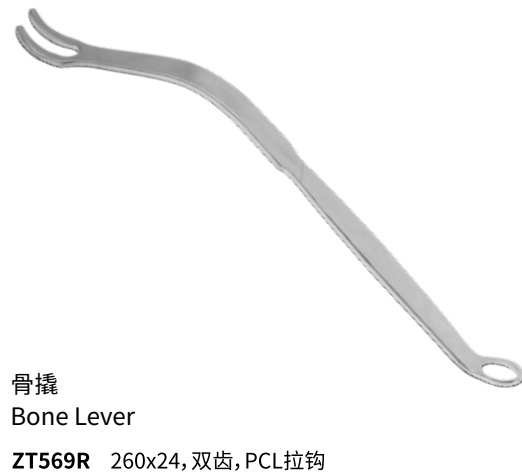
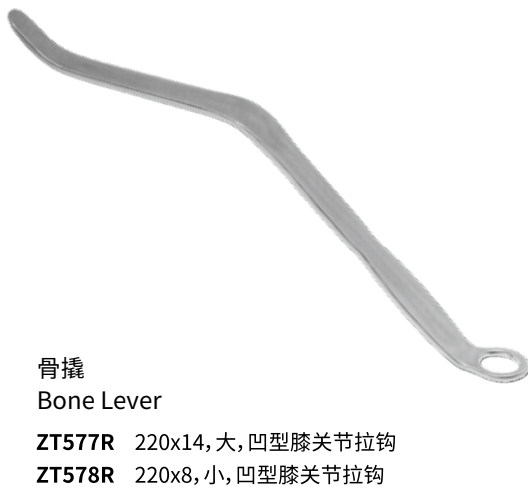

Orthopaedic Instruments  
矫形外科(骨科)

骨撬  
Bone Lever

★ ZT568R 310x15, 弯, 膝关节后韧带拉钩



骨撬 (骨盆复位)  
Bone Lever

ZT822R 290x33, 弯, 平头

ZT823R 255x22, 弯, 平头



骨撬 (高位胫骨截骨)  
Bone Lever

ZT805R 285x12, 弯



骨撬 (高位胫骨截骨)  
Bone Lever

★ ZT557R 弯, 225x5.5

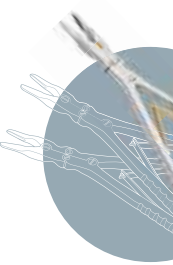

矫形外科(骨科)  
Orthopaedic Instruments

框架自动拉钩 ( 腕关节自动拉钩 )  
Retractor

★ ZT556R 285x248



骨撬  
Bone Lever

★ ZQ648R 230x10



无齿骨撬 ( 胶木柄 )  
Bone Lever

ZQ586R 330



有齿骨撬 ( 胶木柄 )  
Bone Lever

ZQ587R 330

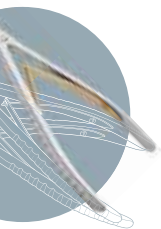



直角柄肌腱拉钩

Retractor

- ★ ZT101R 130x4.5x5.5
- ★ ZT102R 130x5x8
- ★ ZT103R 130x7x7
- ★ ZT104R 150x5x12.5
- ★ ZT105R 180x5x12.5



神经根拉钩 (胶木柄)

Nerve Root Retractor

- ZQ940R 140x138x3x90°
- ZQ941R 140x138x5x90°
- ZQ942R 140x138x7x90°



神经根拉钩 (胶木柄)

Nerve Root Retractor

- ★ ZQ977R 150x130x3x90°, 直角钩, 胶木柄
- ★ ZQ978R 150x130x5x90°, 直角钩, 胶木柄
- ★ ZQ979R 150x130x7x90°, 直角钩, 胶木柄

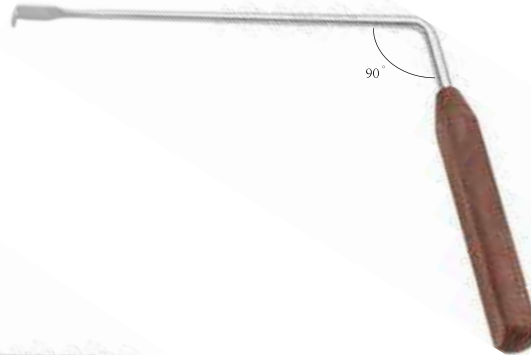

神经根拉钩 (胶木柄)

Nerve Root Retractor

- ZQ937R 230x3x135°
- ZQ938R 230x5x135°
- ZQ939R 230x7x135°

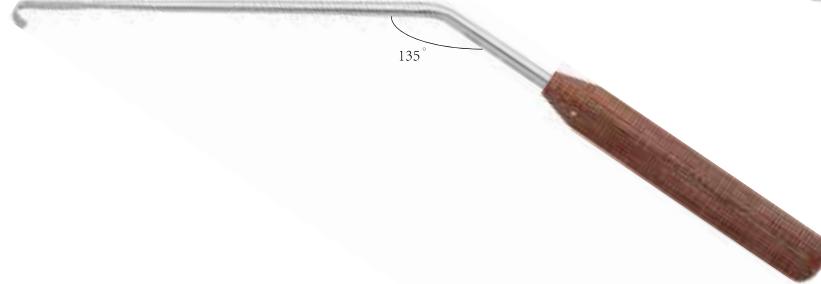

神经根拉钩 (胶木柄)

Nerve Root Retractor

- ★ ZQ974R 230x3x135°, 直角钩, 胶木柄
- ★ ZQ975R 230x5x135°, 直角钩, 胶木柄
- ★ ZQ976R 230x7x135°, 直角钩, 胶木柄

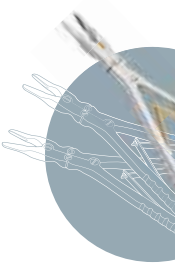
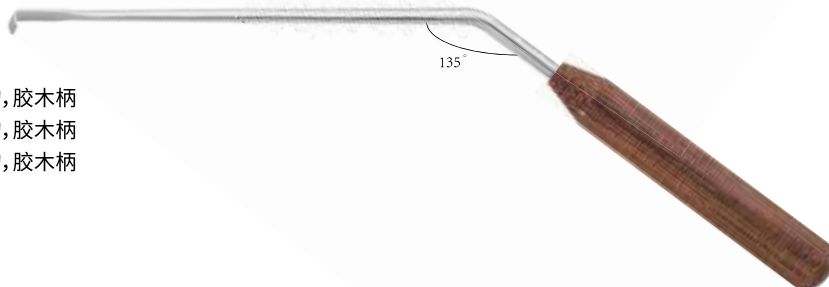

矫形外科(骨科)  
Orthopaedic Instruments

神经根拉钩 (胶木柄)  
Nerve Root Retractor

- ZQ943R 266x3, 直
- ZQ944R 266x5, 直
- ZQ945R 266x7, 直



神经根拉钩 (胶木柄)  
Nerve Root Retractor

- ZQ980R 266x3, 直角钩, 胶木柄
- ★ ZQ981R 266x5, 直角钩, 胶木柄
- ZQ982R 266x7, 直角钩, 胶木柄



神经根拉钩 (板式)  
Nerve Root Retractor

- ZQ2054R 270x3, 直
- ★ ZQ2055R 270x5, 直
- ZQ2056R 270x7, 直



神经根拉钩 (板式)  
Nerve Root Retractor

- ★ ZQ2057R 125x140x3x90°
- ★ ZQ2058R 125x140x5x90°
- ★ ZQ2059R 125x140x7x90°



神经根拉钩 (板式)  
Nerve Root Retractor

- ZQ2060R 230x3x135°
- ★ ZQ2061R 230x5x135°
- ZQ2062R 230x7x135°

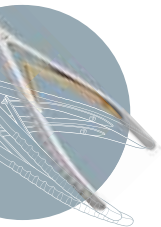

矫形外科  
(骨科)  
Orthopaedic Instruments

神经拉钩  
Nerve Retractor

ZQ120R 160x4



神经拉钩  
Nerve Retractor

- ★ZK411R 230x10x7.5
- ★ZK412R 230x11x8



颈椎拉钩  
Cervical Vertebra Retractor

- ★ZT532R 180x25x50
- ★ZT533R 200x25x56



颈椎拉钩  
Cervical Vertebra Retractor

- ★ZT534RN 182x25x40
- ★ZT535RN 182x25x45
- ★ZT536RN 182x25x50



颈椎 S 型拉钩  
Cervical Vertebra Retractor

- ★ZT596RN 220x26x74

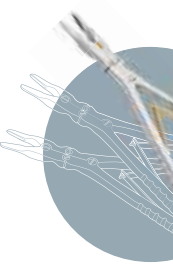

矫形外科(骨科)  
Orthopaedic Instruments

椎板拉钩  
Retractor

- ★ZQ868R 150x25x100
- ★ZQ869R 175x28x100
- ★ZQ965R 175x28x80
- ★ZQ966R 175x25x60
- ★ZQ1430R 210x30x100



椎板拉钩  
Retractor

- ★ZQ967R 200x25x60, 尾部上翘型
- ★ZQ968R 200x25x70, 尾部上翘型
- ★ZQ969R 200x25x80, 尾部上翘型



椎板拉钩  
Retractor

- ★ZQ962R 160x23x60
- ★ZQ963R 160x32x80
- ★ZQ964R 160x32x100



脊柱板拉钩  
Spine Retractor

- ZF814R 170x30x65
- ZF813R 170x25x55

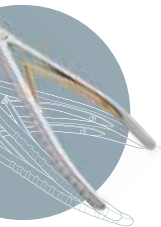

深部椎板拉钩  
Deep Retractor

- ZQ601R 250 带齿 120x60
- ZQ602R 250 带齿 80x40
- ZQ603R 250 带齿 100x50
- ZQ604R 250 带齿 60x30



半月板钩  
Retractor

- ★ ZQ721R 170x56x10



半月板钩  
Retractor

- ★ ZQ722R 180x40x12



半月板钩  
Retractor

- ★ ZQ723R 230x40x10

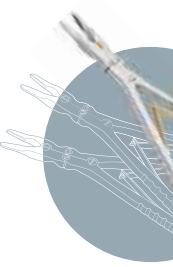

矫形外科(骨科)  
Orthopaedic Instruments

皮肤拉钩  
Skin Retractor Blunt

- ★ ZT424R 200x8.5, 两齿, 钝 Two Teeth
- ★ ZT425R 220x10, 两齿, 钝 Two Teeth
- ★ ZT426R 220x17, 三齿, 钝 Three Teeth
- ★ ZT427R 220x24, 四齿, 钝 Four Teeth



皮肤拉钩  
Skin Retractor Blunt

总长X(齿宽)X(钩深)  
L×W(Teeth)×H

- ZQ2017R 220x(42,22)x(85,65)
- ZQ2018R 220x(33,10)x(48,37)



提骨钩  
Bone Retractor

总厂 X 开口 X 钩深  
L×W×H

- ★ ZQ876R 小, 255x16x12
- ★ ZQ877R 大, 265x25x15



T 型提骨钩  
Bone Retractor T-Shape

- ★ ZQ2019R 200x34x24

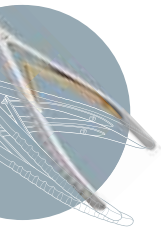

鞍型拉钩

CASPER Retractor

- ★ZT466R 250x80x40
- ★ZT467R 250x70x50
- ★ZT469R 220x90x40
- ZT502R 220x78x60
- ZT187R 220x103x40



鞍型拉钩

CASPER Retractor

- ★ZT468R 270x115x55



硬膜囊拉钩

Retractor

- ZT540R 250x6
- ★ZT541R 250x8
- ★ZT542R 250x10
- ZT543R 250x12



深部骨拉钩

Retractor

注：拉钩长 X 深 X 宽 (mm)  
 Remark:L×W×H

- ★ZQ605R 250x60x20, 圆
- ★ZQ606R 250x80x20, 圆
- ★ZQ607R 250x100x30, 圆
- ★ZQ608R 250x120x30, 圆
- ★ZQ609R 250x140x40, 圆
- ★ZQ610R 250x160x40, 圆
- ZQ611R 250x180x50, 圆
- ZQ612R 250x200x50, 圆

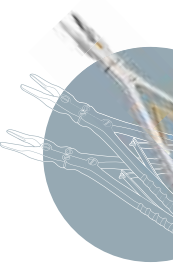

矫形外科(骨科)  
 Orthopaedic Instruments

深部骨拉钩  
 Retractor

注：拉钩长 X 深 X 宽 (mm)

- ★ZQ713R 270x60x20, 平
- ★ZQ714R 270x80x20, 平
- ★ZQ615R 270x100x25, 平
- ★ZQ716R 270x120x25, 平
- ZQ717R 270x140x30, 平
- ZQ718R 270x160x30, 平
- ZQ719R 270x180x35, 平
- ZQ720R 270x200x35, 平



骨拉钩 (胶木柄)  
 Retractor

- ★ZQ649R 235x48x25, 弯
- ★ZQ650R 235x58x25, 弯
- ZQ651R 235x68x25, 弯



鞍形拉钩  
 CASPAR Retractor

- ★ZT464R 210x55x14
- ★ZT465R 210x65x17
- ZT470R 210x75x20



直角拉钩  
 Retractor

注：拉钩长 X 深 X 宽 (mm)

- ★ZT457R 210x55x14, 单头
- ★ZT461R 210x35x14, 单头
- ★ZT462R 210x60x20, 单头
- ★ZT463R 230x105x30, 单头
- ★ZT369R 250x50x30, 单头
- ★ZT370R 250x60x40, 单头
- ★ZT371R 250x80x45, 单头
- ★ZT458R 270x80x25, 单头



直角拉钩  
 Retractor

ZT183R 200x22x5.5



直角拉钩  
 Retractor

ZT190R 235x56x20

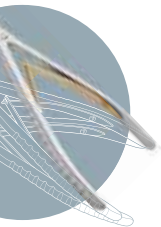



直角拉钩  
Retractor

- ★ ZT459R 230x36x20, 单头
- ★ ZT460R 250x67x25, 单头



创口钩  
Retractor, VOLKMANN

- ★ ZT224R 220, 锐, 四爪 sharp
- ★ ZT229R 220, 钝, 四爪 blunt



创口钩 (肌肉拉钩)  
Retractor, VOLKMANN

- ★ ZT399R 210x35, 扁柄, 三爪, 钝
- ★ ZT400R 210x35, 扁柄, 四爪, 钝
- ★ ZT401R 210x45, 扁柄, 三爪, 钝
- ★ ZT223R 210x45, 扁柄, 四爪, 钝
- ★ ZT402R 210x55, 扁柄, 三爪, 钝
- ★ ZT403R 210x55, 扁柄, 四爪, 钝



深部创口钩 (肌肉拉钩)  
Retractor, VOLKMANN



注: 拉钩长 X 深 X 宽 (mm)

- |                            |                            |                            |
|----------------------------|----------------------------|----------------------------|
| ★ ZT405R 250x35x23, 扁柄, 三爪 | ★ ZT411R 250x35x32, 扁柄, 四爪 | ★ ZT417R 250x35x41, 扁柄, 五爪 |
| ★ ZT406R 250x45x23, 扁柄, 三爪 | ★ ZT412R 250x45x32, 扁柄, 四爪 | ★ ZT418R 250x45x41, 扁柄, 五爪 |
| ★ ZT407R 250x55x23, 扁柄, 三爪 | ★ ZT413R 250x55x32, 扁柄, 四爪 | ★ ZT419R 250x55x54, 扁柄, 五爪 |
| ★ ZT408R 250x65x30, 扁柄, 三爪 | ★ ZT414R 250x65x42, 扁柄, 四爪 | ★ ZT420R 250x65x54, 扁柄, 五爪 |
| ★ ZT409R 250x75x30, 扁柄, 三爪 | ★ ZT415R 250x75x42, 扁柄, 四爪 | ★ ZT421R 250x75x54, 扁柄, 五爪 |
| ★ ZT410R 250x85x30, 扁柄, 三爪 | ★ ZT416R 250x85x42, 扁柄, 四爪 | ★ ZT422R 250x85x54, 扁柄, 五爪 |

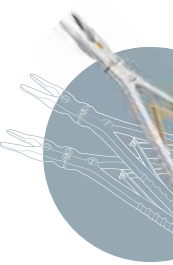

矫形外科(骨科)

深部创口钩 (肌肉拉钩)  
 Retractor, VOLKMANN



注: 拉钩长 X 深 X 宽 (mm)

- |                                   |                                   |                                   |
|-----------------------------------|-----------------------------------|-----------------------------------|
| <b>ZT428R</b> 240x35x23, 圆柄, 三爪   | ★ <b>ZT440R</b> 240x45x32, 圆柄, 四爪 | ★ <b>ZT439R</b> 240x75x54, 圆柄, 五爪 |
| <b>ZT432R</b> 240x45x23, 圆柄, 三爪   | ★ <b>ZT433R</b> 240x55x32, 圆柄, 四爪 | <b>ZT441R</b> 240x85x30, 圆柄, 三爪   |
| ★ <b>ZT429R</b> 240x55x23, 圆柄, 三爪 | ★ <b>ZT434R</b> 240x65x42, 圆柄, 四爪 | ★ <b>ZT442R</b> 240x85x42, 圆柄, 四爪 |
| ★ <b>ZT430R</b> 240x65x30, 圆柄, 三爪 | ★ <b>ZT435R</b> 240x75x42, 圆柄, 四爪 | ★ <b>ZT443R</b> 240x85x54, 圆柄, 五爪 |
| ★ <b>ZT431R</b> 240x75x30, 圆柄, 三爪 | <b>ZT437R</b> 240x55x54, 圆柄, 五爪   |                                   |
| <b>ZT436R</b> 240x35x32, 圆柄, 四爪   | <b>ZT438R</b> 240x65x54, 圆柄, 五爪   |                                   |

下肢截断拉钩 (截肢挡板)  
 Amputation Retractor

**ZQ961R**  $\phi$ 130



骨盆拉钩  
 Retractor

- ZQ724R** 290x124x60 平  
**ZQ727R** 330x174x60 平

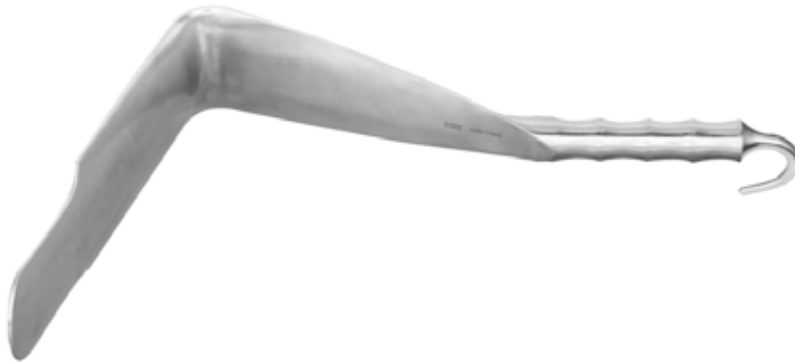

骨盆拉钩  
 Retractor

- ZQ725R** 290x124x60 弯  
**ZQ728R** 330x174x60 弯

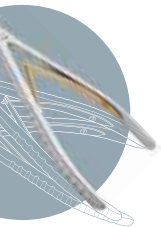

Orthopaedic Instruments  
 矫形外科(骨科)

手指钢板弯曲器  
Plate Bender, one pair

★ ZQ632R 120



钢板折弯器  
Plate Bender, one pair

★ ZQ863R 200, 双头, 左右



骨板折弯器  
Plate Bender, one pair

★ ZQ859R II型, 左、右 (双槽200x3/4, 斜口)



骨板折弯器  
Plate Bender, one pair

★ ZQ861R III型, 左、右 (双槽280x5/6, 斜口)

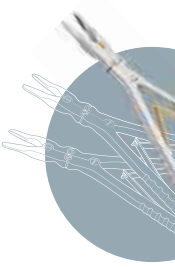

矫形外科(骨科)  
Orthopaedic Instruments

胫骨牵开器 (骨锹)  
 Tibia Retractor

★ ZQ866R 胫骨牵开器 (骨锹)



克氏针折弯钳  
 Kirschner Pin Bender

★ ZK967R 克氏针折弯钳



椎板牵开器  
 Self-retaining Retractor

ZV280R 170x40x12, 单钩, 直角弯  
 ZV281R 170x60x12, 单钩, 直角弯



椎板牵开器  
 Self-retaining Retractor

★ ZV295R 210x40xΦ6, 单钩, 直角弯  
 ★ ZV296R 210x60xΦ6, 单钩, 直角弯  
 ★ ZV297R 210x85xΦ6, 单钩, 直角弯



椎板牵开器  
 Self-retaining Retractor

★ ZV291RN 180x40xΦ3, 单钩  
 ZV292RN 180x50xΦ3, 单钩  
 ★ ZV293RN 180x60xΦ3, 单钩  
 ZV294RN 180x70xΦ3, 单钩

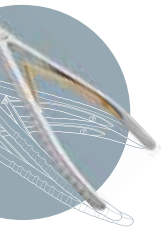

Orthopaedic Instruments  
 矫形外科(骨科)

单侧椎板牵开器  
 Self-retaining Retractor

- left blade, right hook
- ZV283RN** 180x50x20, 左板右钩
- ★ **ZV284RN** 180x60x20, 左板右钩
- ZV285RN** 180x70x20, 左板右钩
- right blade, left hook
- ZV286RN** 180x50x20, 左钩右板
- ZV287RN** 180x60x20, 左钩右板
- ZV288RN** 180x70x20, 左钩右板



单侧椎板牵开器  
 Self-retaining Retractor

- left blade right blade
- ★ **ZV289RN** 180, 左板55x25, 右板65x35



单侧椎板牵开器  
 Self-retaining Retractor

- right blade left blade
- ZV290RN** 180, 右板55x25, 左板65x35



后颅凹牵开器  
 Self-retaining Retractor

- ★ **ZV265RN** 200x60x8, 单钩, 头弯60°



后颅凹牵开器  
 Self-retaining Retractor

- ★ **ZV266RN** 200x18, 固定式4x4钩, 头弯45°
- ZV267RN** 200x30, 固定式4x4钩, 头弯45°

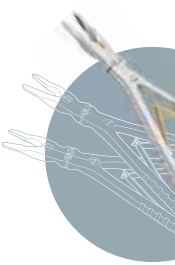

矫形外科(骨科)  
 Orthopaedic Instruments

后颅凹牵开器  
Self-retaining Retractor

★ ZV269RN 220x30, 固定式4x4钩, 头弯45°

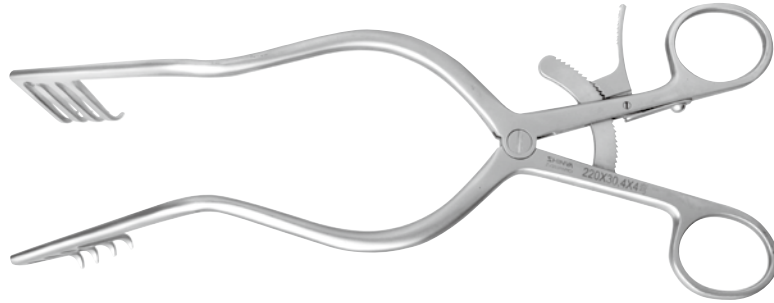

后颅凹牵开器  
Self-retaining Retractor

ZV271RN 280x60, 活动式5x6钩 (活节带齿)



椎板撑开钳  
Lumbar Distractor

★ ZQ959R 230



后颅凹牵开器  
Self-retaining Retractor, blunt

★ ZV272R 280x30, 活动式4x4钝钩, 直型

★ ZV277R 290x23, 活动式4x4钝钩, 直型

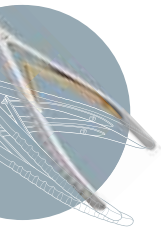

矫形外科 (骨科)  
Orthopaedic Instruments

椎板牵开器  
 Self-retaining Retractor

★ ZV274R 300x45, 活动式5x5钝钩, 直型



颈部牵开器  
 Retractor, Cervical, Complete Set

★ ZV380R 185



颈部牵开器  
 Retractor, Cervical, Complete Set

★ ZV400R 280



颈椎牵开器  
 Retractor, Cervical,  
 Complete Set

★ ZV407RN 140x120, 齿条式(配14对拉钩)

有齿拉钩  
**Toothed hook** 35x20mm 50x20mm 65x20mm  
 40x20mm 55x20mm  
 45x20mm 60x20mm

无齿拉钩  
**Blunt hook** 35x20mm 50x20mm 65x20mm  
 40x20mm 55x20mm  
 45x20mm 60x20mm

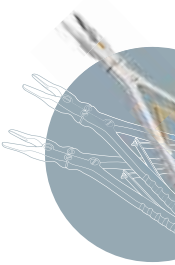
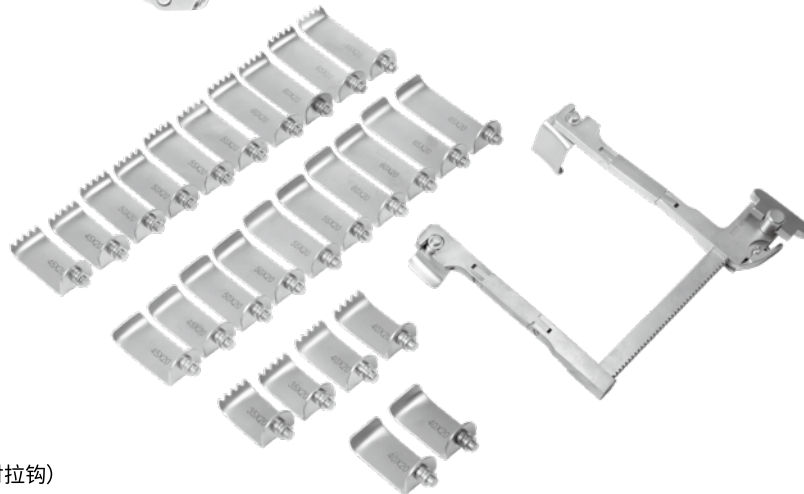

矫形外科(骨科)  
 Orthopaedic Instruments

颈椎牵开器  
Retractor, Cervical, Complete Set

ZV409R/RN 185, 双关节, 钳体



颈椎牵开器  
Retractor, Cervical, Complete Set

ZV410R/RN 235, 三关节, 钳体



牵开拉钩  
Blade

- ZV411R/RN 30x16
- ZV412R/RN 40x16
- ZV413R/RN 50x16
- ZV414R/RN 60x16

配合ZV409R/RN ZV410R/RN使用  
For ZV409R/RN ZV410R/RN



颈椎牵开器  
Retractor, Cervical, Complete Set

★ ZV405RN 包含牵开器1个, 牵开螺钉6个及上钉器1个

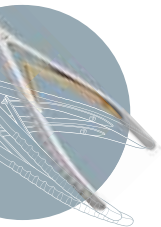

Orthopaedic Instruments  
矫形外科(骨科)



颈椎后缘牵开器  
Retractor

★ ZQ960RN 180x6



钢针固定牵引器  
Pin Fixation Retractor

ZK197R 大号 最大开口 180  
max. opening 180

ZK198R 小号 最大开口 135  
max. opening 135



颅骨牵引器  
Cranial Retractor

★ ZF130R I型, 小号 最大开口 125  
max. opening 125

★ ZF133R I型, 大号 最大开口 135  
max. opening 135



颅骨牵引器  
Cranial Retractor

★ ZF132R II型 最大开口 250  
max. opening 250

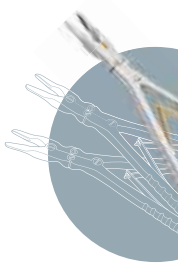
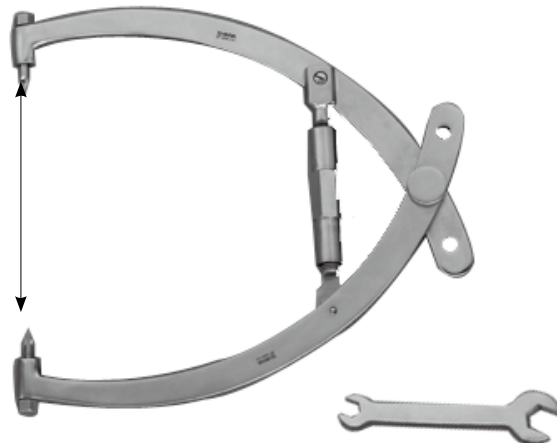

矫形外科(骨科)  
Orthopaedic Instruments

颅骨牵引器  
 Cranial Retractor

- ★ ZF134R III型, 最大开口 160  
 max. opening 160

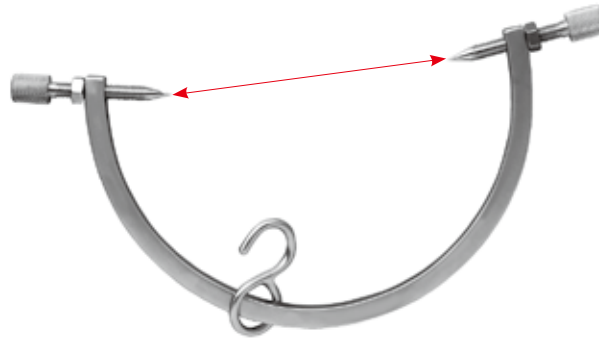

颅骨牵开器  
 Cranial Retractor

- ★ ZK196R 钻孔定位, 配  $\phi 3.5$  钻头 9 个  
 including 9pcs 3.5mm drills



椎间盘窥镜  
 Intervertebral Disc Speculum

- ZV777RNh 40mm
- ZV778RNh 45mm
- ZV779RNh 50mm
- ★ ZV780RNh 55mm
- ★ ZV781RNh 60mm
- ★ ZV782RNh 65mm
- ★ ZV783RNh 75mm
- ZV784RNh 85mm



腰椎牵开器  
 Lumbar Retractor

- ★ ZV760RN 齿条式, 双关节

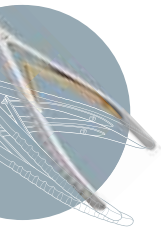

矫形外科(骨科)  
 Orthopaedic Instruments

拉钩 (外侧)  
Blade

- ZV761RNh 35mm
- ZV762RNh 40mm
- ZV763RNh 45mm
- ZV764RNh 50mm
- ★ ZV765RNh 55mm
- ★ ZV766RNh 60mm
- ★ ZV767RNh 65mm
- ★ ZV768RNh 75mm
- ZV769RNh 85mm



拉钩 (内侧)  
Blade

- ZV770RNh 40mm带固定螺钉
- ZV771RNh 45mm带固定螺钉
- ZV772RNh 50mm带固定螺钉
- ★ ZV773RNh 55mm带固定螺钉
- ★ ZV774RNh 60mm带固定螺钉
- ★ ZV775RNh 65mm带固定螺钉
- ★ ZV776RNh 70mm带固定螺钉



腰椎牵开器  
Lumbar Retractor

- ★ ZV720R
- 齿条x臂长 200x155
- 拉钩 54x44
- 65x44
- 73x44
- 83x44
- 2把/种
- 共8把



脊柱深部牵开器  
Spinal Deep Retractor

- ZV713R 50x65, 240x160, 叶6x7齿
- ★ ZV714RN 50x75, 240x160, 叶6x7齿
- ★ ZV715RN 50x85, 240x160, 叶6x7齿
- ZV716R 40x65, 240x160, 叶3x4齿

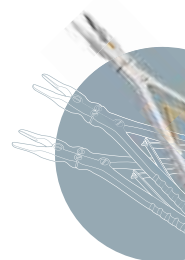

矫形外科(骨科)  
Orthopaedic Instruments

股骨撑开器  
Femoral Spreader

★ ZQ235R II型, 全长430



股骨撑开器  
Femoral Spreader

★ ZQ236R I型, 全长350

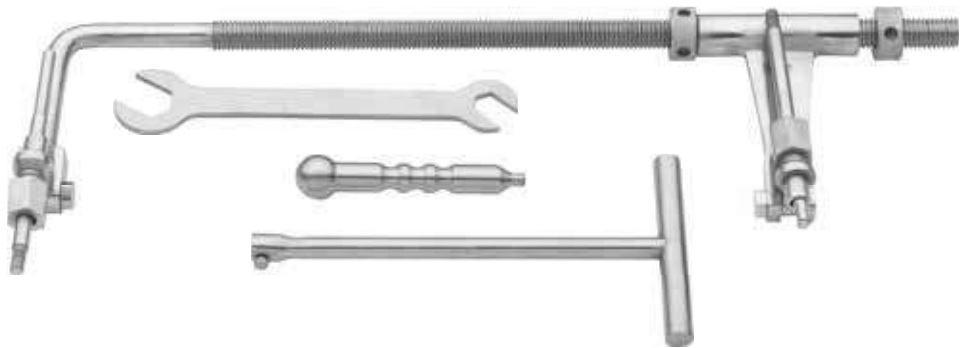

斯式牵引器 (弓)  
Steinmann Traction Bow

★ ZQ873R 小号 255x130

★ ZQ874R 中号 300x155

★ ZQ875R 大号 330x180

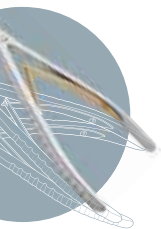
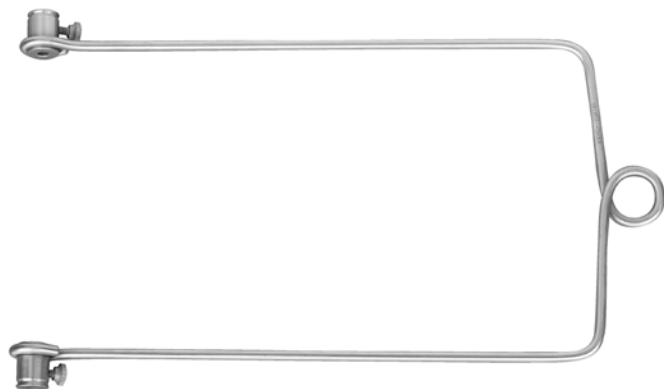

坐骨神经牵开器  
Sciatic Nerve Retractor

ZQ627R 310x30



脊柱撑开器  
Spinal Spreader

★ ZQ1266R 260x65



椎体平行撑开器  
Vertebral Spreader

ZQ1263R 350



压缩钳  
Compressing Forceps

ZQ1541R III型

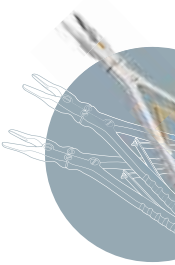
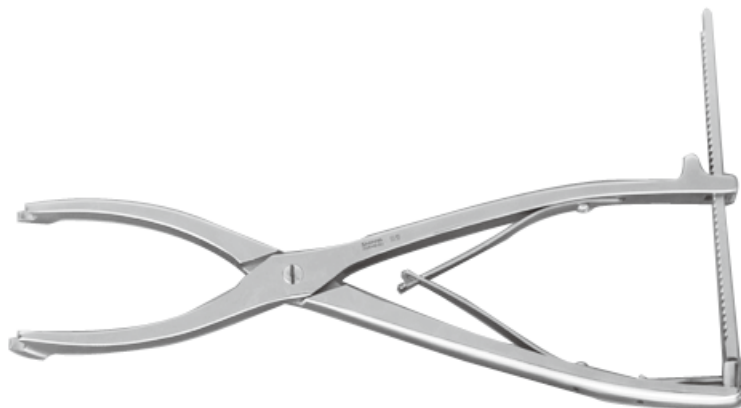

矫形外科(骨科)  
Orthopaedic Instruments

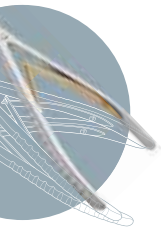

矫形外科(骨科)  
Orthopaedic Instruments

骨科撑开器  
Spreader

★ ZQ1323R 膝关节 195  
头宽20mm



骨科撑开器  
Spreader

★ ZQ1324R 230x16



骨科撑开器  
Spreader

★ ZQ1325R 170x40, 双孔  
孔  $\phi 2.6$ ,  $\phi 1.6$   
撑开最大距离 45mm  
holes: 2.6,1.6  
max. opening:45mm



骨科撑开器  
Spreader

★ ZQ1326R 180x7.5  
撑开最大距离 46mm  
max. opening:46mm



骨科压缩钳  
Compressing Forceps

★ ZQ1545R 180x40, 双孔  
孔  $\phi 2.6$ ,  $\phi 1.6$   
holes: 2.6,1.6



十字改锥 (起子)  
 Cross Screwdriver

- ★ **LS722R** 小, 上肢,  $\Phi 5.5 \times 0.78$
- ★ **ZQ843R** 大, 下肢,  $\Phi 7.9 \times 1$



一字改锥 (起子)  
 Flat Screwdriver

- ★ **LS663R** 小, 上肢, 245x5
- ★ **ZQ839R** 大, 下肢, 245x7
- ★ **ZQ250R** 200, 手指, 200x3



内六角改锥 (起子)  
 Hex

- ★ **ZQ255R** SW1.5
- ★ **ZQ840R** SW2.5
- ★ **ZQ251R** SW2.0
- ★ **ZQ842R** SW4.5
- ★ **ZQ841R** SW3.5
- ★ **ZQ291R** SW4.0
- ★ **ZQ290R** SW3.0

注: “sw” 表示六角对边距离



梅花起子  
 Torx Screwdriver

- |                               |                                |                                |
|-------------------------------|--------------------------------|--------------------------------|
| <b>ZQ261R</b> $\Phi 1.7$ (T6) | <b>ZQ269R</b> $\Phi 2.7$ (T10) | <b>ZQ266R</b> $\Phi 4.3$ (T25) |
| <b>ZQ262R</b> $\Phi 2.0$ (T7) | <b>ZQ271R</b> $\Phi 3.0$       | <b>ZQ275R</b> $\Phi 5.0$ (T27) |
| <b>ZQ264R</b> $\Phi 2.3$ (T8) | <b>ZQ265R</b> $\Phi 3.4$ (T15) | <b>ZQ276R</b> $\Phi 5.5$ (T30) |
| <b>ZQ268R</b> $\Phi 2.5$ (T9) | <b>ZQ274R</b> $\Phi 3.8$ (T20) |                                |

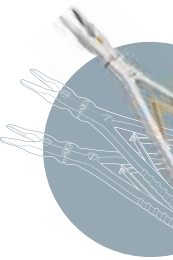

矫形外科(骨科)  
 Orthopaedic Instruments

上钉器  
Screw Applier

ZQ1331R 290, I型, 竹节柄



上钉器  
Screw Applier

ZQ1332R 290, II型, 竹节柄

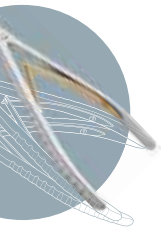

Orthopaedic Instruments  
矫形外科(骨科)

万向内六角起子  
Hex Screwdriver



- ZQ256R SW2.5
- ZQ257R SW3.0
- ZQ258R SW3.5
- ZQ259R SW4.0
- ZQ260R SW4.5



起子  
Cross Screwdriver

- ★ ZK284 内六角 :SW1.5/SW2.0 SW2.5/SW2.5 SW3.0/SW4.0  
SW4.0/SW4.5 SW3.5/2.4 1.2/1.5



起子  
Cross Screwdriver

- ★ ZK285 梅花: T2.3/T2.3 T2.8/T3.8 T3.1/T4.3  
T3.4/T4.3 T4.5/T5.3 3/5

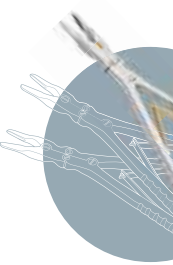

矫形外科(骨科)  
Orthopaedic Instruments

骨锤

Bone Mallet

- ★ ZK042R 200/75g
- ★ ZK044R 200/140g



骨锤

Bone Mallet

- ★ ZQ311R 220/450g

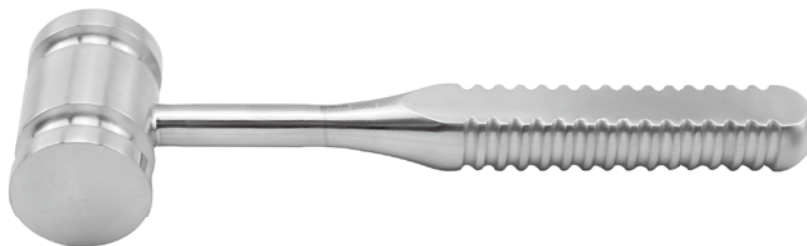

骨锤

Bone Mallet

- ZQ317R 230/270g



骨锤

Bone Mallet

- ★ ZQ312R 220/270g
- ★ ZQ314R 250/500g
- ★ ZQ300R 250/600g
- ★ ZQ315R 250/750g
- ZQ316R 250/1000g



骨锤

Bone Mallet

- ZQ301R 250/290g, 硬平头
- ZQ302R 250/375g, 硬球头
- ZQ303R 250/295g, 硬球平头

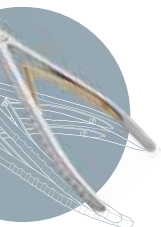

骨锤  
Bone Mallet

- ZQ304R 250/380g, 软平头
- ZQ305R 250/380g, 软球头
- ZQ306R 250/380g, 软球平头



骨锤  
Bone Mallet

- ZQ307R 250/450g, 软硬平头
- ZQ308R 250/470g, 软硬球头
- ZQ309R 250/470g, 软球硬平头
- ZQ310R 250/470g, 软平硬球头

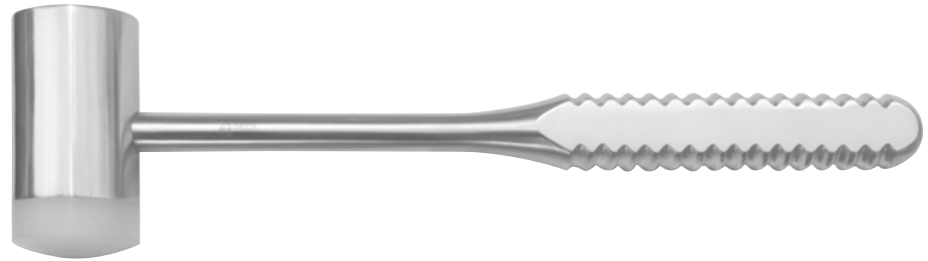

骨锤  
Bone Mallet

- ★ ZK045R 180/50g
- ★ ZK046R 180/70g



骨锤  
Bone Mallet

- ★ ZQ297R 230/250g



锤骨器  
Hammer

- ★ ZQ924RN 210xΦ8
- ★ ZQ925RN 210xΦ10
- ★ ZQ926RN 210xΦ13

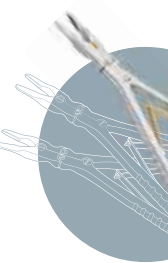

矫形外科(骨科)  
Orthopaedic Instruments

麻花钻头 (骨钻)  
Twist Drill

ZK886R	100xΦ0.8	★ ZK890R	115xΦ2	★ ZK891R	115xΦ4.5
ZK887R	100xΦ1	★ ZK893R	115xΦ2.5	★ ZK718R	150xΦ2.5
ZK888R	100xΦ1.2	★ ZK892R	115xΦ2.8	★ ZK713R	150xΦ2.7
ZK730R	100xΦ1.5	ZK894R	115xΦ3	★ ZK714R	150xΦ3.2
ZK731R	100xΦ1.8	★ ZK895R	115xΦ3.2	★ ZK712R	150xΦ3.5
ZK732R	100xΦ2	★ ZK897R	115xΦ3.5	★ ZK715R	150xΦ4
ZK889R	115xΦ1.6	★ ZK898R	115xΦ4	★ ZK716R	150xΦ4.5



空心钻 (丁字手柄)  
Bone Trephine (T handle)

★ ZK865R	Φ4	★ ZK862R	Φ8
★ ZK867R	Φ5	★ ZQ857R	Φ10
★ ZK861R	Φ7	★ ZK863R	Φ12



丝锥  
Screw Tap

★ ZQ849R	HA2	ZQ852R	HA3.5
ZQ850R	HA2.7	ZQ853R	HA4.5
ZQ851R	HA3	★ ZQ899R	HB4
		ZQ855R	HB6.5



埋头钻  
Drill

LS023R	Φ6
LS024R	Φ8



导向器 (护套, 钻套)  
Guide Double Ended

★ ZK745R	双头, Φ2.5/Φ3.5
★ ZK746R	双头, Φ3.2/Φ4.0
★ ZK747R	双头, Φ3.2/Φ4.5
★ ZK748R	双头, Φ4.5/Φ6.5



骨科钻头 (软管钻)  
Flexible Drill

ZK725R	Φ2.5, 软管钻, 分体型
ZK726R	Φ3.2, 软管钻, 分体型
ZK727R	Φ3.5, 软管钻, 分体型
ZK729R	Φ4.5, 软管钻, 分体型

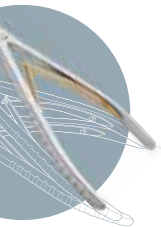

双头导钻 ( 插入导钻 )

Guide

LS325R  $\Phi$ 2.5

LS033R  $\Phi$ 3.2



断钉取出器 ( 断螺钉拔出器 )

Remover Of Broken Bone Screws

★ ZQ872R HA3.5

★ ZQ898R HA4.5

★ ZQ903R HA6.5



螺钉打滑器

Screw Tap

★ ZQ900R SW2.5

★ ZQ901R SW3.5



螺钉夹持器 ( 镊 )

Screw Holding Forceps

★ ZQ902R HA3.5-4.5

ZQ907R HA2.0



螺钉夹持钳

Screw Holding Forceps

★ ZQ906R HA2.0

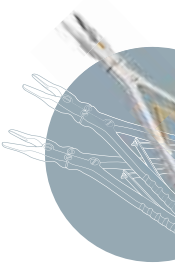

矫形外科(骨科)  
Orthopaedic Instruments

髓腔铰刀  
 Cannulated Reamer For Medullary Cave, malleable



- ZQ762R Φ8    ZQ764R Φ10    ZQ766R Φ12  
 ZQ763R Φ9    ZQ765R Φ11

髓腔铰刀  
 Reamer For Medullary Cave

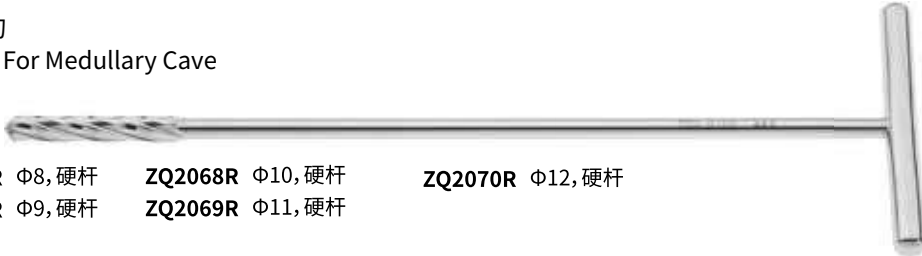

- ZQ2066R Φ8, 硬杆    ZQ2068R Φ10, 硬杆    ZQ2070R Φ12, 硬杆  
 ZQ2067R Φ9, 硬杆    ZQ2069R Φ11, 硬杆

探测器  
 Depth Measurer



- ★ ZQ613R 60    ★ ZQ249R 30  
 ★ LS004R 90

手摇骨钻  
 Bunnell Hand Drill

- ★ ZK005R 夹持Φ0.4-4mm钻头  
 for 0.4-4mm drill



手摇骨钻  
 Bunnell Hand Drill

- ★ ZK006R 夹持Φ6以下钻头  
 for drill less than 6mm

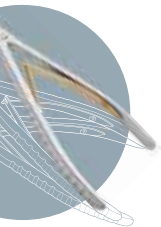
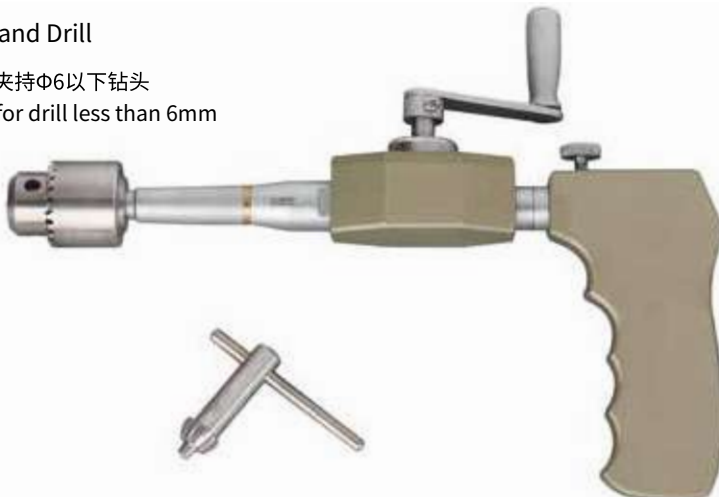

矫形外科(骨科)  
 Orthopaedic Instruments

神经根探子  
Nerve Root Probe

★ ZQ930R 210xφ3



钢丝引导器 (导丝器)  
Wire Guide



ZQ1136R 250x30°x20      ZQ1138R 250x30°x30  
★ ZQ1137R 250x30°x25      ★ ZQ1139R 250x30°x35

钢丝引导器 (导丝器)  
Wire Guide

★ ZQ1148R 250xR23x48, 左弯 left curved      ZQ1150R 250xR23x48, 直型 straight  
★ ZQ1149R 250xR23x48, 右弯 right curved



空心钢丝引导器  
Cannulated Wire Guide



ZQ1151R 225xR22x35, 直型 straight      ★ ZQ1153R 240xR30x60, 左弯 left curved      ★ ZQ1134R 240xR30x60, 右弯 right curved  
★ ZQ1152R 240xR30x50, 直型 straight      ZQ1154R 240xR22x45, 左弯 left curved      ZQ1135R 240xR22x45, 右弯 right curved  
注: 内径φ2mm inner dia. 2mm

钢丝穿引器  
Wire Guide

★ ZQ1159R 303x48, 大号  
★ ZQ1160R 258x39, 小号  
注: 内径φ2mm inner dia. 2mm

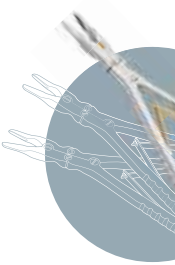

矫形外科(骨科)  
Orthopaedic Instruments

钢丝缠绕器  
Wire Twister

ZK277R 255



打孔器  
Punch

ZK428R 股骨 for femur  
ZK429R 胫骨 for tibia



开路锥  
Awl

ZQ1297R 颈椎型 cervical vertebra  
ZQ1298R 腰椎型 lumbar vertebra



椎弓根开孔器  
Vertebral Pedicle Awl

ZQ1299R 230xΦ5



可调椎弓根开孔器  
Vertebral Pedicle Awl, adjustable

ZQ1284R 260xΦ3.5

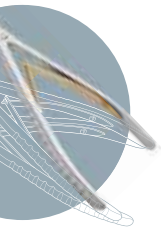

矫形外科(骨科)  
Orthopaedic Instruments



椎弓根匙形开孔器 (胶木柄)  
Vertebral Pedicle Awl, spoon shaped

ZQ1268R 200x3, 胸椎



椎弓根匙形开孔器 (胶木柄)  
Vertebral Pedicle Awl, spoon shaped

ZQ1269R 215x3, 腰椎



手钻  
Hand Drill

ZQ640R 160xΦ1.6



定位针把持器  
Positioning Pin Holder

ZQ1295R 280



定位针  
Positioning Pins

ZQ1296R 70xΦ2.5, 一套两支 2 pcs/set  
(有槽无槽各一支)

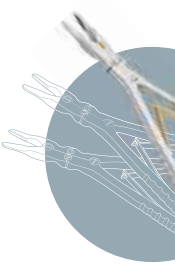
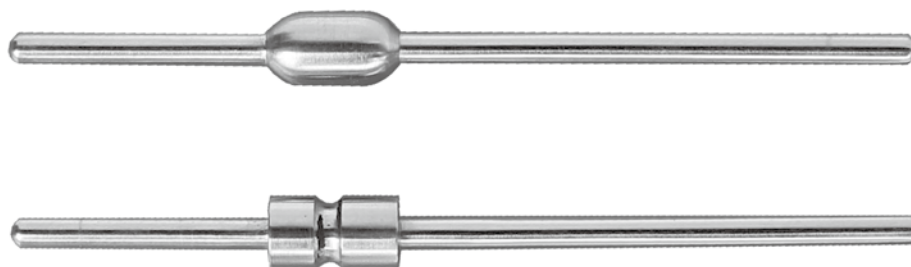

矫形外科(骨科)  
Orthopaedic Instruments

弯棒器  
 Bar Bender  
 ZQ1281R 弯棒器



双向弯曲钳  
 Two-way Bending  
 Forceps  
 ★ ZQ908R 245, 双向



椎管骨打击器  
 Vertebral Tubal Striker

- ★ ZQ2041R 260x3.5x90°
- ★ ZQ2042R 260x5x90°
- ★ ZQ2043R 260x6.5x90°



椎管骨打击器  
 Vertebral Tubal Striker

- ★ ZQ2044R 260x3.5x110°
- ★ ZQ2045R 260x5x110°
- ★ ZQ2046R 260x6.5x110°



植骨打入器  
 Bone Grafting Impactor

- ★ ZQ1322R 220x15x10, 滚花柄

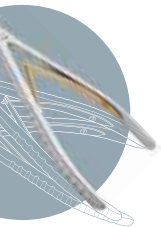

矫形外科(骨科)  
 Orthopaedic Instruments

椎弓根探子

Vertebral Arch Probe



- ★ ZQ2032R 230xΦ2, 带刻度
- ★ ZQ2033R 230xΦ2.5, 带刻度

椎弓根探子

Vertebral Arch Probe



- ★ ZQ2034R 230xΦ2, 弹性
- ZQ2035R 230xΦ2.5, 弹性

角度尺

Angle Gauge

ZQ2023R 调整范围90°-180°



角度尺

Angle Gauge

ZQ2024R 95°



角度尺

Angle Gauge

ZQ2025R 130°

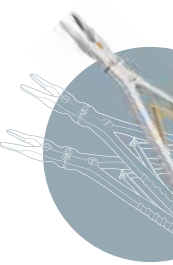

矫形外科(骨科)  
Orthopaedic Instruments

寰弓剥离子  
Atlas Bow Raspatory

★ ZQ2049R 270x4x5, 微弯



寰弓剥离子  
Atlas Bow Raspatory

★ ZQ2050R 270x3, 深弯



软钻导向器 (钢板导钻)  
Plate Guide

ZK757R 适用范围  $\Phi 2.5-\Phi 4$



X 射线摄影尺  
X Ray Photography Ruler

★ ZA807R 200 ★ ZA809R 400  
★ ZA808R 300



C 形导钻 (套)  
Guide, C-shape



ZK733R 1# (35x $\phi 6$  导钻架,  $\phi 2.5$ ,  $\phi 3.5$  导钻头)  
ZK734R 2# (42x $\phi 6$  导钻架,  $\phi 3.2$ ,  $\phi 4.5$  导钻头)

ZK735R 3# (42x $\phi 8$  导钻架,  $\phi 6.5$  导钻头)

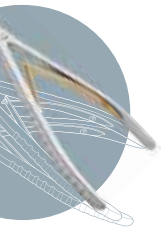

矫形外科 (骨科)  
Orthopaedic Instruments

断钉拔出钳  
Broken Screw Removal Forceps

★ ZQ2121RN 200, 夹持H3-5



剥离钩  
Raspatory Hook

★ ZQ2076RN 160xR6x10, 锐



换柄式较刀  
Reamer, handle changeable

★ ZQ1947RN 150, 三角刃长20



换柄式六角起子  
Hex Screwdriver, handle changeable

★ ZQ2079RN 90xSw1.5

★ ZQ2082RN 90xSw3.0

★ ZQ2085RN 90xSw4.5

★ ZQ2080RN 90xSw2.0

★ JQ2083RN 90xSw3.5

★ ZQ2086RN 90xSw5.0

★ JQ2081RN 90xSw2.5

★ ZQ2084RN 90xSw4.0

★ ZQ2087RN 90xSw5.5

换柄式四方起子  
Square Screwdriver, handle changeable

★ JQ2092RN 90xSw1.2

★ JQ2093RN 90xSw1.5

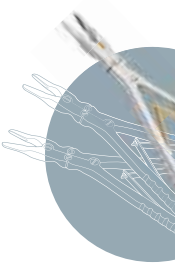

矫形外科(骨科)  
Orthopaedic Instruments

换柄式一字起子  
Flat Screwdriver, handle changeable



- ★ ZQ2100RN 90x0.5x3
- ★ ZQ2101RN 90x0.6x6

换柄式十字起子  
Cross Screwdriver, handle changeable



- ★ JQ2108RN 90x0.4x2

换柄式 U 型上钉器  
Screw Applier, U-shape, handle changeable



- ★ ZQ1335RN 90xR2.5x11

换柄式断钉拔出 (取出) 器  
Remover of Broken Screws, handle changeable



- ★ ZQ2115RN 195xH3.5
- ★ ZQ2116RN 195xH4.5

换柄式梅花起子  
Torx Screwdriver, handle changeable



- ★ JQ2127RN 90xT8(φ2.3)
- ★ JQ2130RN 90xT15(φ3.3)
- ★ JQ2132RN 90xT25(φ4.4)
- ★ JQ2129RN 90xT10(φ2.7)
- ★ ZQ2131RN 90xT20(φ3.8)
- ★ ZQ2134RN 90xT30(φ5.4)

硬质合金钻头  
Drill



- ★ ZQ2144RN 80xφ5
- ★ ZQ2150RN 80xφ7
- ★ ZQ2147RN 80xφ6

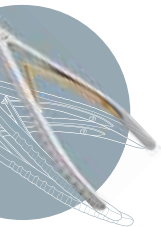

螺钉打滑取出器  
Hexagon Sliding Screw Extractor, handle changeable



- ★ ZQ2154RN 90xSw2.5    ZQ2157RN 90xSw4.0
- ★ ZQ2156RN 90xSw3.5

圆骨刀 (铝合金柄)  
Gouge



- ★ ZQ1240RN 200x8, 直, 圆刃

换柄式空心钻  
Bone Trephine, handle changeable



- ★ ZQ2161RN 90xH2.0( $\phi$ 2.3)    ★ ZQ2168RN 150xH4.0( $\phi$ 4.3)    ★ ZQ2174RN 150xH6.5( $\phi$ 6.8)
- ★ ZQ2164RN 90xH2.7( $\phi$ 3)    ★ ZQ2171RN 150xH5.0( $\phi$ 5.3)    ★ ZQ2177RN 150xH8.0( $\phi$ 8.2)

脊椎环钻  
Vertebral Trephine

- ZF859R 170x $\phi$ 8
- ZF860R 160x $\phi$ 15



换柄式取钉环钻  
Screw Trephine, handle changeable



- ★ ZQ2180RN 90x4.0    ★ ZQ2185RN 90x6.5
- ★ ZQ2182RN 90x5.0

直型快换手柄  
Handle, straight



- ★ ZQ2188RN 160

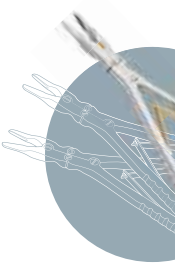

矫形外科(骨科)  
Orthopaedic Instruments

T型快换手柄  
Handle, T-shape

★ ZQ2189RN 100



关节微创牵开器  
Joint Retractor

**ZV561R** GWQ-I型  
框架 200x200  
拉钩 180x12x22  
180x24x40  
190x24x55  
190x24x70  
190x24x85  
190x24x100

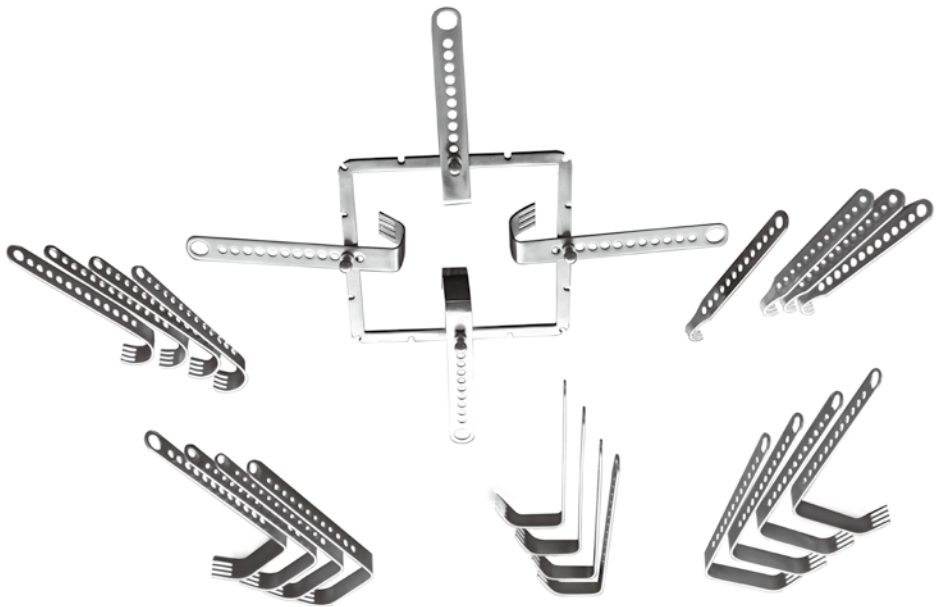

石膏剪  
Plastic Shear

**LS758R** 直柄

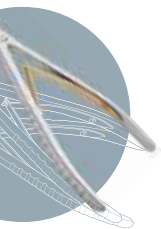

矫形外科(骨科)  
Orthopaedic Instruments



布朗式牵引架  
Traction Frame

★ ZV750R 布朗式牵引架

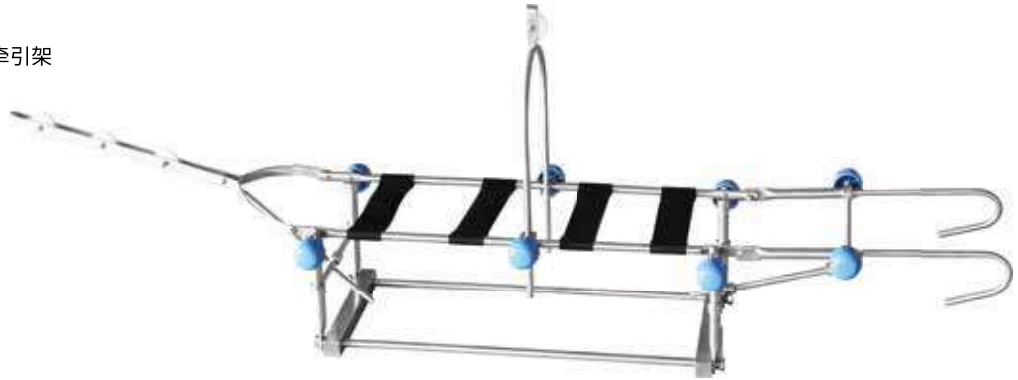

床头牵引架  
Reposition Forceps

★ ZV751R

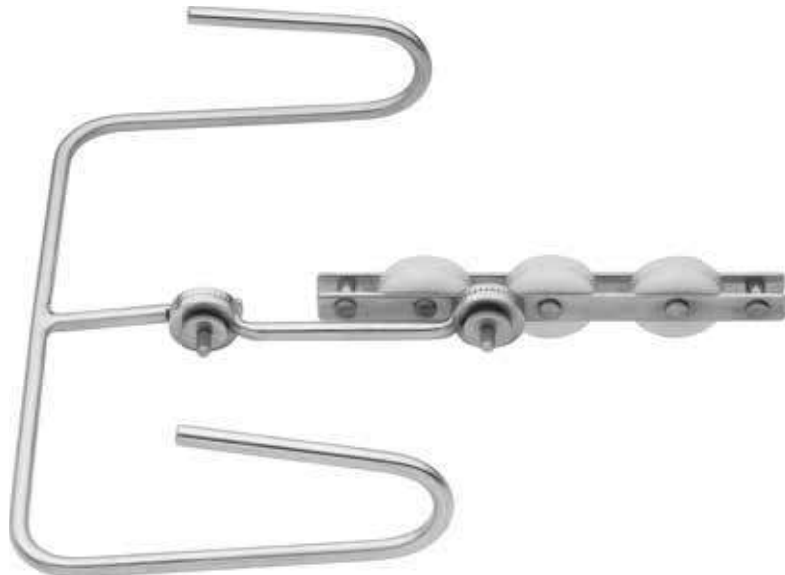

枪式复位钳  
Reposition Forceps

ZK236R 枪式

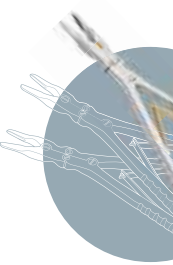

矫形外科(骨科)  
Orthopaedic Instruments

椎板咬骨钳  
 Kerrison Punch

- ★ JF1056RNh 230x4x110°超薄型,可拆式
- ★ JF1064RNh 230x4x130°超薄型,可拆式
- ★ JF1055RNh 230x3x110°超薄型,可拆式
- ★ JF1046RNh 230x2x90° 超薄型,可拆式
- ★ JF1047RNh 230x3x90° 超薄型,可拆式
- ★ JF1062RNh 230x2x130°超薄型,可拆式
- ★ JF1063RNh 230x3x130°超薄型,可拆式
- ★ JF1054RNh 230x2x110°超薄型,可拆式
- ★ JF1072RNh 200x1x90° 超薄型,可拆式
- ★ JF1073RNh 230x1x90° 超薄型,可拆式
- ★ JF1076RNh 200x1x130°超薄型,可拆式
- ★ JF1077RNh 230x1x130°超薄型,可拆式



髓核钳  
 Laminectomy Rongeur

- ★ JF574RB 220x3
- ★ JF578RB 220x4
- ★ JF590RB 220x3x150°
- ★ JF594RB 220x4x150°



双关节咬骨钳  
 Bone Rongeur

- ★ JK637RT 240x3, 直尖头      straight
- ★ JK641RT 240x3, 弯尖头      curved

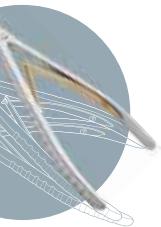
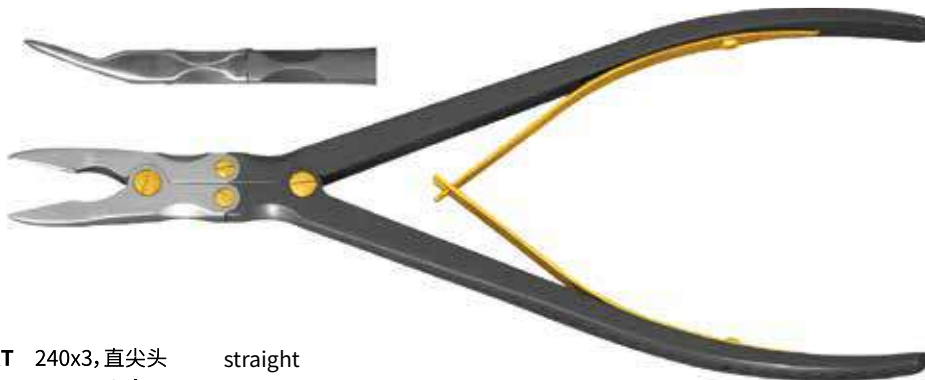

矫形外科(骨科)  
 Orthopaedic Instruments

双关节咬骨钳  
 Bone Rongeur



- |                                 |                                 |
|---------------------------------|---------------------------------|
| <b>JK437RT</b> 240x6直头 straight | <b>JK440RT</b> 240x7弯头 curved   |
| <b>JK438RT</b> 240x6弯头 curved   | <b>JK435RT</b> 240x8直头 curved   |
| <b>JK439RT</b> 240x7直头 straight | <b>JK436RT</b> 240x8弯头 straight |

双关节咬骨钳  
 Bone Rongeur



- |                                 |                                 |                                   |
|---------------------------------|---------------------------------|-----------------------------------|
| <b>JK585RT</b> 240x2直头 straight | <b>JK793RT</b> 240x6直头 straight | <b>JK592RT</b> 240x5弯头 curved     |
| <b>JK606RT</b> 240x3直头 straight | <b>JK589RT</b> 240x2弯头 curved   | <b>JK593RT</b> 240x2x38°弯头 curved |
| <b>JK587RT</b> 240x4直头 straight | <b>JK590RT</b> 240x3弯头 curved   | <b>JK595RT</b> 240x4x38°弯头 curved |
| <b>JK588RT</b> 240x5直头 straight | <b>JK591RT</b> 240x4弯头 curved   | <b>JK794RT</b> 240x6弯头 curved     |

钢针剪  
 TC Wire Cutting Scissors



- ★ **JK279RB** 220mm, φ2.2以下,  
 镶合金片  
 for wire less than 2.2

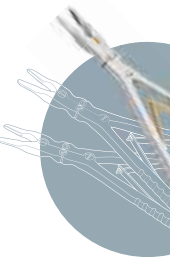

矫形外科(骨科)  
 Orthopaedic Instruments

骨刀 (胶木柄)  
 Chisel



**JQ2700RB** 160x10, 直平口, 单斜刃  
**JQ2701RB** 160x15, 直平口, 单斜刃  
**JQ2702RB** 200x10, 直平口, 单斜刃

**JQ2703RB** 200x15, 直平口, 单斜刃  
**JQ2704RB** 200x20, 直平口, 单斜刃

骨刀 (胶木柄)  
 Chisel



**JQ2705RB** 200x10, 弧形, 单斜刃  
**JQ2706RB** 200x15, 弧形, 单斜刃

**JQ2707RB** 200x20, 弧形, 单斜刃

骨刀 (胶木柄)  
 Chisel



**JQ2708RB** 180x4, 直平口, 双斜刃  
**JQ2709RB** 180x6, 直平口, 双斜刃  
**JQ2710RB** 180x8, 直平口, 双斜刃

**JQ2711RB** 180x10, 直平口, 双斜刃  
**JQ2712RB** 180x12, 直平口, 双斜刃

骨刀 (胶木柄)  
 Gouge



**JQ2713RB** 180x4, 圆口, 双斜刃  
**JQ2714RB** 180x6, 圆口, 双斜刃  
**JQ2715RB** 180x8, 圆口, 双斜刃

**JQ2716RB** 180x10, 圆口, 双斜刃  
**JQ2717RB** 180x12, 圆口, 双斜刃

骨刀 (胶木柄)  
 Chisel



**JQ2718RB** 220x5, 直平口, 双斜刃  
 ★ **JQ2719RB** 220x7, 直平口, 双斜刃  
 ★ **JQ2720RB** 220x10, 直平口, 双斜刃

**JQ2721RB** 220x15, 直平口, 双斜刃  
**JQ2722RB** 220x20, 直平口, 双斜刃

**JQ2723RB** 220x25, 直平口, 双斜刃  
**JQ2724RB** 220x30, 直平口, 双斜刃

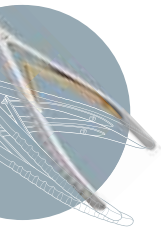

矫形外科 (骨科)  
 Orthopaedic Instruments

骨刀 (胶木柄)  
Gouge



**JQ2725RB** 220x5, 圆口, 斜刃

**JQ2726RB** 220x7, 圆口, 斜刃

**JQ2727RB** 220x10, 圆口, 斜刃

**JQ2728RB** 220x15, 圆口, 斜刃

**JQ2729RB** 220x20, 圆口, 斜刃

**JQ2730RB** 220x25, 圆口, 斜刃

**JQ2731RB** 220x30, 圆口, 斜刃

骨刀 (胶木柄)  
Gouge



**JQ2732RB** 220x9, 平口, 半圆弧形斜刃

骨刀 (胶木柄)  
Chisel



**JQ2733RB** 245x20, 直平口, 单斜刃

**JQ2734RB** 265x16, 直平口, 弧形单斜刃

骨刀 (胶木柄)  
Gouge



**JQ824RB** 260x6, 直头平口, 单斜刃

**JQ825RB** 260x8, 直头平口, 单斜刃

**JQ826RB** 260x10, 直头平口, 单斜刃

**JQ827RB** 260x12, 直头平口, 单斜刃

骨刀 (胶木柄)  
Gouge



**JQ1648RB** 300x8, 梯形, 超薄圆刃

**JQ1649RB** 300x10, 梯形, 超薄圆刃

**JQ1650RB** 300x12, 梯形, 超薄圆刃

**JQ1651RB** 300x15, 梯形, 超薄圆刃

**JQ1652RB** 300x18, 梯形, 超薄圆刃

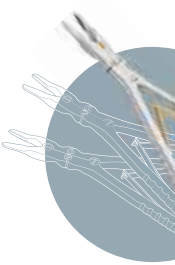

矫形外科(骨科)  
Orthopaedic Instruments

骨刀 (胶木柄)  
Chisel



- |                       |                         |                         |
|-----------------------|-------------------------|-------------------------|
| JQ1599RB 350x6, 超薄圆刃  | ★ JQ1598RB 300x6, 超薄圆刃  | ★ JQ1597RB 270x6, 超薄圆刃  |
| JQ1616RB 350x8, 超薄圆刃  | ★ JQ1600RB 300x8, 超薄圆刃  | ★ JQ1632RB 270x8, 超薄圆刃  |
| JQ1617RB 350x10, 超薄圆刃 | ★ JQ1601RB 300x10, 超薄圆刃 | ★ JQ1633RB 270x10, 超薄圆刃 |
| JQ1618RB 350x12, 超薄圆刃 | ★ JQ1602RB 300x12, 超薄圆刃 | JQ1634RB 270x12, 超薄圆刃   |
| JQ1619RB 350x15, 超薄圆刃 | ★ JQ1603RB 300x15, 超薄圆刃 | ★ JQ1635RB 270x15, 超薄圆刃 |
| JQ1620RB 350x18, 超薄圆刃 | JQ1604RB 300x18, 超薄圆刃   | JQ1636RB 270x18, 超薄圆刃   |
| JQ1621RB 350x20, 超薄圆刃 | JQ1605RB 300x20, 超薄圆刃   | JQ1637RB 270x20, 超薄圆刃   |
| JQ1622RB 350x25, 超薄圆刃 | JQ1606RB 300x25, 超薄圆刃   | JQ1638RB 270x25, 超薄圆刃   |
| JQ1623RB 350x30, 超薄圆刃 | JQ1607RB 300x30, 超薄圆刃   | JQ1639RB 270x30, 超薄圆刃   |

骨刀 (胶木柄)  
Gouge



- |                           |                           |                           |
|---------------------------|---------------------------|---------------------------|
| JQ1838RB 270x6, 直平口, 超薄刃  | JQ1842RB 270x15, 直平口, 超薄刃 | JQ1850RB 300x10, 直平口, 超薄刃 |
| JQ1839RB 270x8, 直平口, 超薄刃  | JQ1848RB 300x6, 直平口, 超薄刃  | JQ1851RB 300x12, 直平口, 超薄刃 |
| JQ1840RB 270x10, 直平口, 超薄刃 | JQ1849RB 300x8, 直平口, 超薄刃  | JQ1852RB 300x15, 直平口, 超薄刃 |
| JQ1841RB 270x12, 直平口, 超薄刃 |                           |                           |

骨刀 (胶木柄)  
Chisel



- |                           |                           |                           |
|---------------------------|---------------------------|---------------------------|
| JQ1658RB 270x6, 直圆口, 超薄刃  | JQ1662RB 270x15, 直圆口, 超薄刃 | JQ1670RB 300x10, 直圆口, 超薄刃 |
| JQ1659RB 270x8, 直圆口, 超薄刃  | JQ1668RB 300x6, 直圆口, 超薄刃  | JQ1671RB 300x12, 直圆口, 超薄刃 |
| JQ1660RB 270x10, 直圆口, 超薄刃 | JQ1669RB 300x8, 直圆口, 超薄刃  | JQ1672RB 300x15, 直圆口, 超薄刃 |
| JQ1661RB 270x12, 直圆口, 超薄刃 |                           |                           |

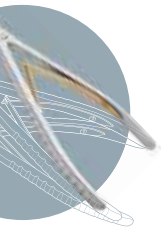

骨凿 (滚花柄)  
Chisel



- JQ381RB** 220x4, 直, 单斜刃, 滚花柄      **JQ385RB** 220x8, 直, 单斜刃, 滚花柄      **JQ389RB** 220x12, 直, 单斜刃, 滚花柄  
★ **JQ383RB** 220x6, 直, 单斜刃, 滚花柄      **JQ387RB** 220x10, 直, 单斜刃, 滚花柄

骨凿 (滚花柄)  
Chisel



- JQ382RB** 220x4, 弯, 单斜刃, 滚花柄      **JQ386RB** 220x8, 弯, 单斜刃, 滚花柄      **JQ390RB** 220x12, 弯, 单斜刃, 滚花柄  
**JQ384RB** 220x6, 弯, 单斜刃, 滚花柄      **JQ388RB** 220x10, 弯, 单斜刃, 滚花柄

骨凿 (滚花柄)  
Gouge



- ★ **JQ436RB** 220x6, 直, 双斜刃, 滚花柄, 颈椎用  
★ **JQ437RB** 220x9, 直, 双斜刃, 滚花柄, 颈椎用  
★ **JQ438RB** 220x12, 直, 双斜刃, 滚花柄, 颈椎用

骨凿 (滚花柄)  
Gouge



- JQ775RB** 200x3 (颈椎用), 直      **JQ777RB** 200x5 (颈椎用), 直      ★ **JQ779RB** 200x8 (颈椎用), 直  
**JQ776RB** 200x4 (颈椎用), 直      ★ **JQ778RB** 200x6 (颈椎用), 直      **JQ780RB** 200x10 (颈椎用), 直

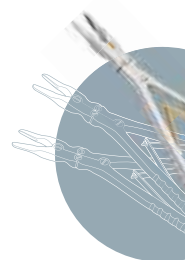

矫形外科(骨科)  
Orthopaedic Instruments

骨凿 (滚花柄)  
 Gouge



**JQ790RB** 180x2 (手指用), 直  
**JQ791RB** 180x3 (手指用), 直

★ **JQ792RB** 180x4 (手指用), 直  
 ★ **JQ793RB** 180x5 (手指用), 直

**JQ794RB** 180x6 (手指用), 直

骨刀 (PPSU 柄)  
 Chisel



★ **JQ2500RN** 300x8, 超薄圆刃, PPSU柄  
 ★ **JQ2501RN** 300x10, 超薄圆刃, PPSU柄

★ **JQ2502RN** 300x12, 超薄圆刃, PPSU柄  
 ★ **JQ2503RN** 300x15, 超薄圆刃, PPSU柄

骨刀 (PPSU 柄)  
 Gouge



**JQ2600RN** 300x6, 直平口, 超薄刃, PPSU柄  
**JQ2601RN** 300x8, 直平口, 超薄刃, PPSU柄  
**JQ2602RN** 300x10, 直平口, 超薄刃, PPSU柄

**JQ2603RN** 300x12, 直平口, 超薄刃, PPSU柄  
**JQ2604RN** 300x15, 直平口, 超薄刃, PPSU柄

骨刀 (滚花柄)  
 Chisel



**JQ1695RN** 300x2, 滚花柄  
**JQ1696RN** 300x4, 滚花柄  
**JQ1697RN** 300x6, 滚花柄

**JQ1698RN** 300x8, 滚花柄  
**JQ1875RN** 250x2, 滚花柄  
**JQ1876RN** 250x4, 滚花柄

**JQ1877RN** 250x6, 滚花柄  
**JQ1878RN** 250x8, 滚花柄

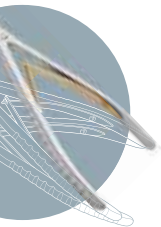



骨刀 (滚花柄)  
Chisel



**JQ436RN** 220x6, 直, 双斜刃, 滚花柄, 颈椎用  
**JQ437RN** 220x9, 直, 双斜刃, 滚花柄, 颈椎用

**JQ438RN** 220x12, 直, 双斜刃, 滚花柄, 颈椎用

骨刀 (滚花柄)  
Chisel



**JQ790RN** 180x2, 直, 双斜刃  
**JQ792RN** 180x4, 直, 双斜刃

**JQ794RN** 180x6, 直, 双斜刃  
**JQ658RN** 180x8, 直, 双斜刃

骨凿 (滚花柄)  
Gouge



**JQ381RN** 220x4, 直, 单斜刃, 滚花柄  
**JQ383RN** 220x6, 直, 单斜刃, 滚花柄

**JQ385RN** 220x8, 直, 单斜刃, 滚花柄  
**JQ387RN** 220x10, 直, 单斜刃, 滚花柄

**JQ389RN** 220x12, 直, 单斜刃, 滚花柄

骨凿 (滚花柄)  
Gouge



**JQ382RN** 220x4, 弯, 单斜刃, 滚花柄  
**JQ384RN** 220x6, 弯, 单斜刃, 滚花柄

**JQ386RN** 220x8, 弯, 单斜刃, 滚花柄  
**JQ388RN** 220x10, 弯, 单斜刃, 滚花柄

**JQ390RN** 220x12, 弯, 单斜刃, 滚花柄

截骨刀 (六角柄)  
Chisel



★ **JQ401RN** 230x8, 直, 超薄圆刃, 六角柄  
★ **JQ402RN** 230x10, 直, 超薄圆刃, 六角柄

★ **JQ403RN** 230x12, 直, 超薄圆刃, 六角柄  
★ **JQ398RN** 230x15, 直, 超薄圆刃, 六角柄

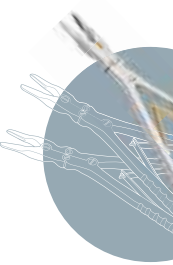

矫形外科(骨科)  
Orthopaedic Instruments

颈椎骨刮匙 (铝合金)  
Bone Curette



- ★ **JQ1118RB** 240x2x45°, 单弯后, 枪状
- ★ **JQ1119RB** 240x3x45°, 单弯后, 枪状
- JQ1120RB** 240x4x45°, 单弯后, 枪状
- JQ1121RB** 240x5x45°, 单弯后, 枪状

颈椎骨刮匙 (铝合金)  
Bone Curette



- ★ **JQ1110RB** 240x2, 直头, 枪状
- ★ **JQ1111RB** 240x3, 直头, 枪状
- JQ1112RB** 240x4, 直头, 枪状
- JQ1113RB** 240x5, 直头, 枪状

颈椎骨刮匙 (铝合金)  
Bone Curette



- ★ **JQ1114RB** 240x2x45°, 单弯前, 枪状
- ★ **JQ1115RB** 240x3x45°, 单弯前, 枪状
- JQ1116RB** 240x4x45°, 单弯前, 枪状
- JQ1117RB** 240x5x45°, 单弯前, 枪状

骨刮匙 (胶木柄)  
Bone Curette



- JQ1438RB** 300x1x25°, 前弯
- JQ1444RB** 300x2x25°, 前弯
- JQ1452RB** 300x3x25°, 前弯
- JQ1460RB** 300x4x25°, 前弯
- JQ1468RB** 300x5x25°, 前弯
- JQ1476RB** 300x6x25°, 前弯
- JQ1484RB** 300x7x25°, 前弯

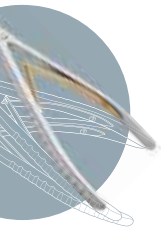

骨刮匙 (胶木柄)  
Bone Curette



- |                            |                           |                           |
|----------------------------|---------------------------|---------------------------|
| <b>JQ1433RB</b> 300x1, 直   | <b>JQ1488RB</b> 300x9, 直  | <b>JQ2405RB</b> 380x6, 直  |
| <b>JQ1439RB</b> 300x2, 直   | <b>JQ1491RB</b> 300x10, 直 | <b>JQ2406RB</b> 380x7, 直  |
| ★ <b>JQ1445RB</b> 300x3, 直 | <b>JQ1494RB</b> 300x12, 直 | <b>JQ2407RB</b> 380x8, 直  |
| ★ <b>JQ1453RB</b> 300x4, 直 | <b>JQ1497RB</b> 300x15, 直 | <b>JQ2408RB</b> 380x9, 直  |
| ★ <b>JQ1461RB</b> 300x5, 直 | <b>JQ2401RB</b> 380x2, 直  | <b>JQ2409RB</b> 380x10, 直 |
| ★ <b>JQ1469RB</b> 300x6, 直 | <b>JQ2402RB</b> 380x3, 直  | <b>JQ2410RB</b> 380x12, 直 |
| <b>JQ1477RB</b> 300x7, 直   | <b>JQ2403RB</b> 380x4, 直  | <b>JQ2411RB</b> 380x15, 直 |
| <b>JQ1485RB</b> 300x8, 直   | <b>JQ2404RB</b> 380x5, 直  |                           |

骨刮匙 (胶木柄)  
Bone Curette



- |                                 |                               |                                |
|---------------------------------|-------------------------------|--------------------------------|
| <b>JQ1436RB</b> 300x1x15°, 前弯   | <b>JQ2437RB</b> 380x2x15°, 前弯 | <b>JQ2444RB</b> 380x9x15°, 前弯  |
| <b>JQ1442RB</b> 300x2x15°, 前弯   | <b>JQ2438RB</b> 380x3x15°, 前弯 | <b>JQ2445RB</b> 380x10x15°, 前弯 |
| ★ <b>JQ1450RB</b> 300x3x15°, 前弯 | <b>JQ2439RB</b> 380x4x15°, 前弯 | <b>JQ2446RB</b> 380x12x15°, 前弯 |
| ★ <b>JQ1458RB</b> 300x4x15°, 前弯 | <b>JQ2440RB</b> 380x5x15°, 前弯 | <b>JQ2447RB</b> 380x15x15°, 前弯 |
| <b>JQ1466RB</b> 300x5x15°, 前弯   | <b>JQ2441RB</b> 380x6x15°, 前弯 |                                |
| <b>JQ1474RB</b> 300x6x15°, 前弯   | <b>JQ2442RB</b> 380x7x15°, 前弯 |                                |
| <b>JQ1482RB</b> 300x7x15°, 前弯   | <b>JQ2443RB</b> 380x8x15°, 前弯 |                                |

骨刮匙 (胶木柄)  
Bone Curette



- |                           |                           |                           |
|---------------------------|---------------------------|---------------------------|
| <b>JQ1446RB</b> 300x3, 左弯 | <b>JQ1462RB</b> 300x5, 左弯 | <b>JQ1478RB</b> 300x7, 左弯 |
| <b>JQ1454RB</b> 300x4, 左弯 | <b>JQ1470RB</b> 300x6, 左弯 |                           |

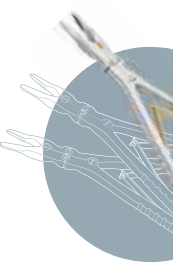

矫形外科(骨科)  
Orthopaedic Instruments

骨刮匙 (胶木柄)  
Bone Curette



- JQ1447RB** 300x3, 右弯    **JQ1463RB** 300x5, 右弯    **JQ1479RB** 300x7, 右弯  
**JQ1455RB** 300x4, 右弯    **JQ1471RB** 300x6, 右弯

骨刮匙 (胶木柄)  
Bone Curette



- JQ1083RB** 300x2x45°, 正口, 枪型    **JQ1085RB** 300x4x45°, 正口, 枪型    **JQ1087RB** 300x6x45°, 正口, 枪型  
**JQ1084RB** 300x3x45°, 正口, 枪型    **JQ1086RB** 300x5x45°, 正口, 枪型    **JQ1088RB** 300x7x45°, 正口, 枪型

骨刮匙 (胶木柄)  
Bone Curette



- JQ1550RB** 300x2, 反口45°, 枪型    **JQ1552RB** 300x4, 反口45°, 枪型    **JQ1554RB** 300x6, 反口45°, 枪型  
**JQ1551RB** 300x3, 反口45°, 枪型    **JQ1553RB** 300x5, 反口45°, 枪型    **JQ1555RB** 300x7, 反口45°, 枪型

骨刮匙 (胶木柄)  
Bone Curette



- JQ1556RB** 300x2, 反口90°, 枪型    **JQ1558RB** 300x4, 反口90°, 枪型    **JQ1560RB** 300x6, 反口90°, 枪型  
**JQ1557RB** 300x3, 反口90°, 枪型    **JQ1559RB** 300x5, 反口90°, 枪型    **JQ1561RB** 300x7, 反口90°, 枪型

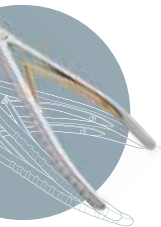

矫形外科 (骨科)  
Orthopaedic Instruments

骨刮匙 (胶木柄)  
Bone Curette



- |                                |                                |                                 |
|--------------------------------|--------------------------------|---------------------------------|
| <b>JQ1500RB</b> 300x4, 直, 带齿   | <b>JQ1503RB</b> 300x7, 直, 带齿   | <b>JQ1505RB</b> 300x9, 直, 带齿    |
| ★ <b>JQ1501RB</b> 300x5, 直, 带齿 | ★ <b>JQ1504RB</b> 300x8, 直, 带齿 | ★ <b>JQ1506RB</b> 300x10, 直, 带齿 |
| ★ <b>JQ1502RB</b> 300x6, 直, 带齿 |                                |                                 |

骨刮匙 (PPSU)  
Bone Curette



- |                                   |                                   |                                 |
|-----------------------------------|-----------------------------------|---------------------------------|
| ★ <b>JQ1580RN</b> 270x2, 直, PPSU柄 | ★ <b>JQ1589RN</b> 270x5, 直, PPSU柄 | <b>JQ1567RN</b> 300x4, 直, PPSU柄 |
| ★ <b>JQ1583RN</b> 270x3, 直, PPSU柄 | <b>JQ1565RN</b> 300x2, 直, PPSU柄   | <b>JQ1568RN</b> 300x5, 直, PPSU柄 |
| ★ <b>JQ1586RN</b> 270x4, 直, PPSU柄 | <b>JQ1566RN</b> 300x3, 直, PPSU柄   |                                 |

骨刮匙 (PPSU)  
Bone Curette



- |                                        |                                        |                                        |
|----------------------------------------|----------------------------------------|----------------------------------------|
| <b>JQ1581RN</b> 270x2x15°, 前弯, PPSU柄   | <b>JQ1590RN</b> 270x5x15°, 前弯, PPSU柄   | ★ <b>JQ1571RN</b> 300x4x15°, 前弯, PPSU柄 |
| ★ <b>JQ1584RN</b> 270x3x15°, 前弯, PPSU柄 | ★ <b>JQ1569RN</b> 300x2x15°, 前弯, PPSU柄 | <b>JQ1572RN</b> 300x5x15°, 前弯, PPSU柄   |
| ★ <b>JQ1587RN</b> 270x4x15°, 前弯, PPSU柄 | ★ <b>JQ1570RN</b> 300x3x15°, 前弯, PPSU柄 |                                        |

骨刮匙 (PPSU)  
Bone Curette



- |                                        |                                        |                                        |
|----------------------------------------|----------------------------------------|----------------------------------------|
| <b>JQ1582RN</b> 270x2x30°, 前弯, PPSU柄   | <b>JQ1591RN</b> 270x5x30°, 前弯, PPSU柄   | ★ <b>JQ1512RN</b> 300x4x30°, 前弯, PPSU柄 |
| ★ <b>JQ1585RN</b> 270x3x30°, 前弯, PPSU柄 | ★ <b>JQ1510RN</b> 300x2x30°, 前弯, PPSU柄 | <b>JQ1513RN</b> 300x5x30°, 前弯, PPSU柄   |
| ★ <b>JQ1588RN</b> 270x4x30°, 前弯, PPSU柄 | <b>JQ1511RN</b> 300x3x30°, 前弯, PPSU柄   |                                        |

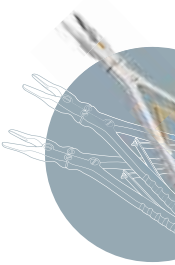

矫形外科(骨科)  
Orthopaedic Instruments

扩孔器  
Reamer



- ZQ3043RN** 200×φ5
- ZQ3044RN** 185×φ7
- ZQ3045RN** 170×φ9
- ZQ3046RN** 155×φ11
- ZQ3047RN** 140×φ13
- ZQ3048RN** 125×φ15

扩孔器 (实心)  
Reamer

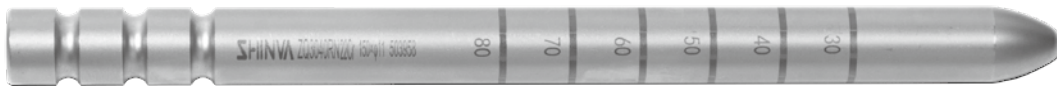

- ZQ3039RN** 150×φ5
- ZQ3040RN** 150×φ11
- ZQ3041RN** 150×φ13
- ZQ3042RN** 150×φ15

骨定位针  
Guiding Pin



- ZQ3003RN** 210×φ5

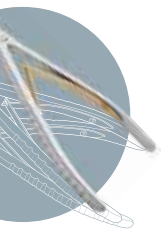

骨锤  
Bone Mallet



ZQ3004RN 225/140g

骨刀  
Gouge



ZQ3007RN  
250×5, 右弯



ZQ3008RN  
250×5, 左弯



ZQ3006RN  
240×4, 前弯



ZQ3092RN  
250×4, 直

ZQ3090RN  
245×5×15°, 前弯

ZQ3009RN  
250×5, 直

ZQ3091RN  
245×5×30°, 前弯

ZQ3093RN  
250×6, 直



ZQ3005RN  
240



ZQ3010RN 200×5, 直



ZQ3011RN 200×5, 弯

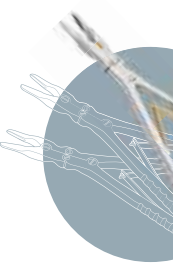

矫形外科(骨科)  
Orthopaedic Instruments

骨刮匙  
 Bone Curette



- ZQ3013RN** 260×3×30°, 前弯
- ZQ3014RN** 260×5×30°, 前弯
- ZQ3015RN** 260×6×30°, 前弯



- ZQ3016RN** 260×3×45°, 反口
- ZQ3060RN** 260×6×45°, 反口



- ZQ3017RN**  
230×3×130°, 前弯

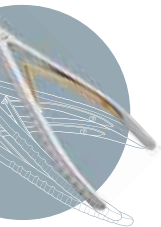

Orthopaedic Instruments  
 矫形外科(骨科)

创口钩 (半套管牵开器)  
 Retractor



- ZQ3056RN** 50×12.5
- ZQ3057RN** 60×12.5
- ZQ3058RN** 70×12.5
- ZQ3059RN** 80×12.5

骨膜剥离器 (肌肉剥离器)  
 Periosteal Raspatory



- ZQ3037RN** 165



骨膜剥离器 (终板分离器)  
Periosteal Raspatory



**ZQ3019RN**  
260×7×5°, 弯



**ZQ3020RN**  
260×7×25°, 弯



**ZQ3097RN**  
220×9×45°, 弯, 方头

骨膜剥离器 (双头剥离器)  
Periosteal Raspatory



**ZQ3300RN**  
300×1, 深弯  
**ZQ3302RN**  
300×2, 深弯  
**ZQ3032RN**  
300×3, 深弯

**ZQ3030RN**  
300×4, 深弯  
**ZQ3028RN**  
300×5.5, 深弯



**ZQ3099RN**  
300×1, 微弯  
**ZQ3301RN**  
300×2, 微弯  
**ZQ3031RN**  
300×3, 微弯

**ZQ3029RN**  
300×4, 微弯  
**ZQ3027RN**  
300×5.5, 微弯

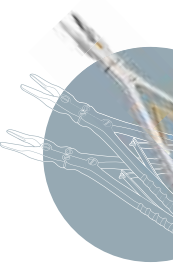

矫形外科(骨科)  
Orthopaedic Instruments

骨铰刀  
 Reamer



- ZQ3305RN 230×4
- ZQ3306RN 230×5
- ZQ3307RN 230×6
- ZQ3038RN 230×8

显微钩 (神经根剥离器)  
 Raspatory



ZQ3002RN  
 230×7

ZQ3095RN  
 230×5, 单头

神经根拉钩  
 Nerve Root Retractor

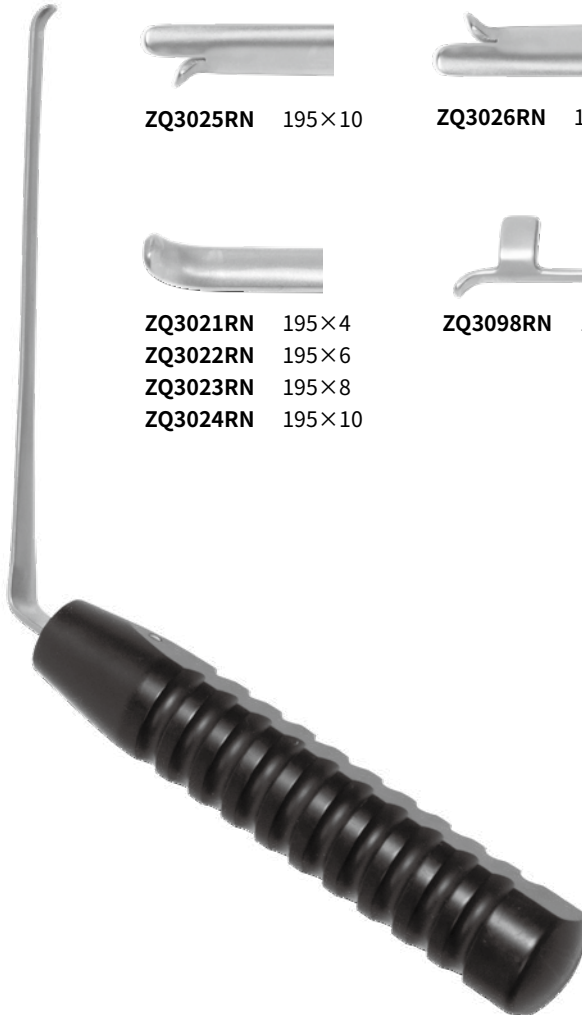

ZQ3025RN 195×10

ZQ3026RN 195×10

- ZQ3021RN 195×4
- ZQ3022RN 195×6
- ZQ3023RN 195×8
- ZQ3024RN 195×10

ZQ3098RN 195×4

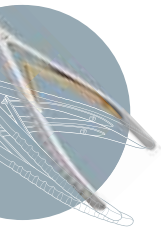

矫形外科 (骨科)  
 Orthopaedic Instruments

双室漏斗  
Funnel



ZQ3061RN 165×φ8

植骨器 (植骨推棒)  
Bone Grafting



ZQ3062RN 280×φ6.5

吸引管  
Suction Tube



ZQ3033RN 200×φ3, 弯



ZQ3036RN 170×φ3, 弯

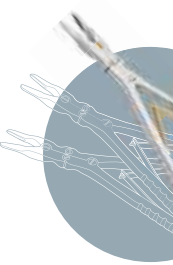

矫形外科(骨科)  
Orthopaedic Instruments

显微刀  
 Micro Knife



ZQ3096RN 230

神经剥离器  
 Raspatory



ZQ3001RN 230×5

植骨器 (融合器打入器)  
 Bone Grafting



ZQ3012RN 235



ZQ3094RN 235

骨用牵开器 (弹簧撑开器)  
 Bone Retractor



ZQ3050RN 35×10  
 ZQ3051RN 50×10  
 ZQ3052RN 50×20  
 ZQ3053RN 60×20  
 ZQ3054RN 70×20  
 ZQ3055RN 80×20

护套管  
 Drivepipe



ZQ3311RN 40×φ7  
 ZQ3312RN 50×φ7  
 ZQ3313RN 60×φ7

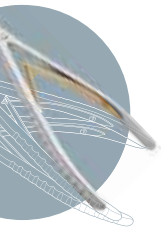

矫形外科 (骨科)  
 Orthopaedic Instruments

椎板咬骨钳 (旋转椎板咬骨钳)  
Kerrison Punch, Detachable

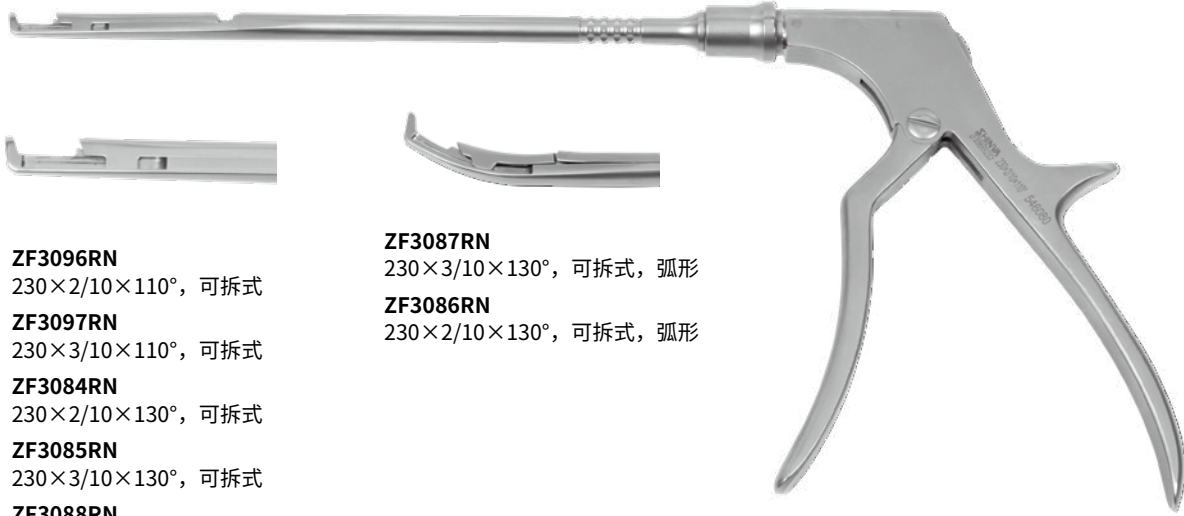

- ZF3096RN**  
230×2/10×110°, 可拆式
- ZF3097RN**  
230×3/10×110°, 可拆式
- ZF3084RN**  
230×2/10×130°, 可拆式
- ZF3085RN**  
230×3/10×130°, 可拆式
- ZF3088RN**  
230×4/10×130°, 可拆式

- ZF3087RN**  
230×3/10×130°, 可拆式, 弧形
- ZF3086RN**  
230×2/10×130°, 可拆式, 弧形

髓核钳 (精细型)  
Laminectomy Rongeur

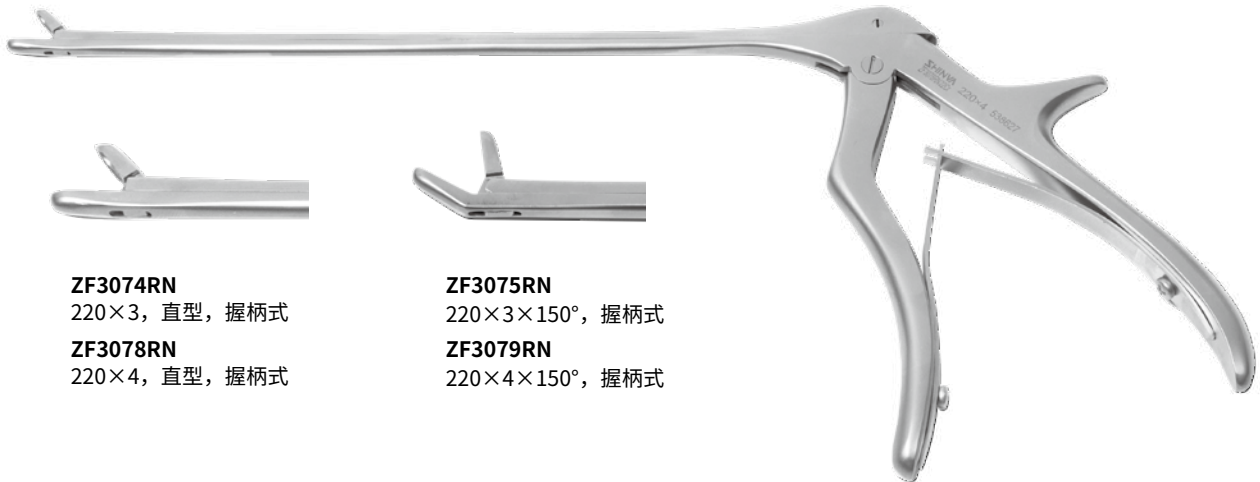

- ZF3074RN**  
220×3, 直型, 握柄式
- ZF3078RN**  
220×4, 直型, 握柄式

- ZF3075RN**  
220×3×150°, 握柄式
- ZF3079RN**  
220×4×150°, 握柄式

髓核钳  
Laminectomy Rongeur



- ZF3089RN**  
230×2, 直型, 指圈式

- ZF3090RN**  
230×2×150°, 指圈式

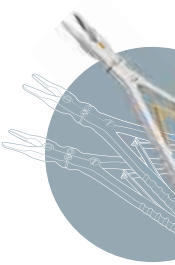

矫形外科(骨科)  
Orthopaedic Instruments

### JZWC- III 脊柱微创手术器械 (ZQ2998) Minimauly Invasive Spine Surgery Set

序号	产品编码	产品名称	规格型号	数量	单位
1	ZQ3001RN	神经剥离器	230×5	1	把
2	ZQ3004RN	骨锤	225/140g	1	把
3	ZQ3005RN	骨刀	240	1	把
4	ZQ3091RN	骨刀	245×5×30°, 前弯	1	把
5	ZQ3007RN	骨刀	250×5, 右弯	1	把
6	ZQ3008RN	骨刀	250×5, 左弯	1	把
7	ZQ3009RN	骨刀	250×5, 直	1	把
8	ZQ3010RN	骨刀	200×5, 直	1	把
9	ZQ3011RN	骨刀	200×5, 弯	1	把
10	ZQ3012RN	植骨器	/	1	把
11	ZQ3013RN	骨刮匙	260×3×30°, 前弯	1	把
12	ZQ3014RN	骨刮匙	260×5×30°, 前弯	1	把
13	ZQ3016RN	骨刮匙	260×3×45°, 反口	1	把
14	ZQ3095RN	显微钩	230×5, 单头	1	把
15	ZQ3096RN	显微刀	230	1	把
16	ZQ3020RN	骨膜剥离器	260×7×25°, 弯	1	把
17	ZQ3097RN	骨膜剥离器	220×9×45°, 弯, 方头	1	把
18	ZQ3098RN	神经根拉钩	195×4	1	把
19	ZQ3021RN	神经根拉钩	195×4	1	把
20	ZQ3022RN	神经根拉钩	195×6	1	把
21	ZQ3023RN	神经根拉钩	195×8	1	把
22	ZQ3031RN	骨膜剥离器	300×3, 微弯	1	把
23	ZQ3032RN	骨膜剥离器	300×3, 深弯	1	把
24	ZQ3033RN	吸引管	200×φ3, 弯	1	把
25	ZQ3038RN	骨铰刀	230×8	1	把
26	ZQ3043RN	扩孔器	200×φ5	1	把
27	ZQ3044RN	扩孔器	185×φ7	1	把
28	ZQ3045RN	扩孔器	170×φ9	1	把
29	ZQ3046RN	扩孔器	155×φ11	1	把
30	ZQ3047RN	扩孔器	140×φ13	1	把
31	ZQ3056RN	创口钩	50×12.5	1	把
32	ZQ3057RN	创口钩	60×12.5	1	把
33	ZQ3058RN	创口钩	70×12.5	1	把
34	ZQ3059RN	创口钩	80×12.5	1	把

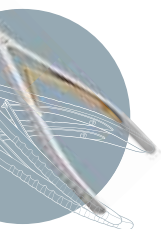

矫形外科  
(骨科)  
Orthopaedic Instruments

序号	产品编码	产品名称	规格型号	数量	单位
35	ZQ3061RN	双室漏斗	165×φ8	1	把
36	ZQ3062RN	植骨器	280×φ6.5	1	把
37	ZF3084RN	椎板咬骨钳	230×2/10×130°，可拆式	1	把
38	ZF3085RN	椎板咬骨钳	230×3/10×130°，可拆式	1	把
39	ZF3087RN	椎板咬骨钳	230×3/10×130°，可拆式，弧形	1	把
40	ZF3088RN	椎板咬骨钳	230×4/10×130°，可拆式	1	把
41	ZF3089RN	髓核钳	230×2，直型，指圈式	1	把
42	ZF3090RN	髓核钳	230×2×150°，指圈式	1	把
43	ZF3074RN	髓核钳	220×3，直型，握柄式	1	把
44	ZF3075RN	髓核钳	220×3×150°，握柄式	1	把
45	ZF3078RN	髓核钳	220×4，直型，握柄式	1	把

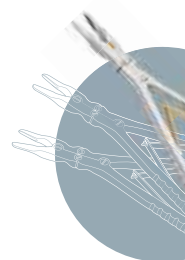

矫形外科(骨科)  
 Orthopaedic Instruments



JZWC-I 脊柱微创手术器械 (ZQ3000)  
Minimally Invasive Spine Surgery Set

序号	产品编码	产品名称	规格型号	数量	单位
1	ZQ3001RN	神经剥离器	230×5	1	把
2	ZQ3002RN	显微钩	230×7	1	把
3	ZQ3003RN	骨定位针	210×φ5	1	把
4	ZQ3004RN	骨锤	225/140g	1	把
5	ZQ3005RN	骨刀	240	1	把
6	ZQ3006RN	骨刀	240×4, 前弯	1	把
7	ZQ3007RN	骨刀	250×5, 右弯	1	把
8	ZQ3008RN	骨刀	250×5, 左弯	1	把
9	ZQ3009RN	骨刀	250×5, 直	1	把
10	ZQ3010RN	骨刀	200×5, 直	1	把
11	ZQ3011RN	骨刀	200×5, 弯	1	把
12	ZQ3012RN	植骨器	/	1	把
13	ZQ3013RN	骨刮匙	260×3×30°, 前弯	1	把
14	ZQ3014RN	骨刮匙	260×5×30°, 前弯	1	把
15	ZQ3015RN	骨刮匙	260×6×30°, 前弯	1	把
16	ZQ3016RN	骨刮匙	260×3×45°, 反口	1	把
17	ZQ3017RN	骨刮匙	230×3×130°, 前弯	1	把
18	ZQ1257RN	神经剥离器	240×5, 带钩	1	把
19	ZQ3019RN	骨膜剥离器	260×7×5°, 弯	1	把
20	ZQ3020RN	骨膜剥离器	260×7×25°, 弯	1	把

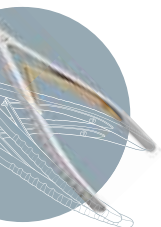



序号	产品编码	产品名称	规格型号	数量	单位
21	ZQ3021RN	神经根拉钩	195×4	1	把
22	ZQ3022RN	神经根拉钩	195×6	1	把
23	ZQ3023RN	神经根拉钩	195×8	1	把
24	ZQ3024RN	神经根拉钩	195×10	1	把
25	ZQ3025RN	神经根拉钩	195×10	1	把
26	ZQ3026RN	神经根拉钩	195×10	1	把
27	ZQ3031RN	骨膜剥离器	300×3, 微弯	1	把
28	ZQ3032RN	骨膜剥离器	300×3, 深弯	1	把
29	ZQ3033RN	吸引管	200×φ3, 弯	1	支
30	ZQ3036RN	吸引管	170×φ3, 弯	1	支
31	ZQ3037RN	骨膜剥离器	165	1	把
32	ZQ3038RN	骨铰刀	230×8	1	把
33	ZQ3039RN	扩孔器	150×φ5	1	把
34	ZQ3040RN	扩孔器	150×φ11	1	把
35	ZQ3041RN	扩孔器	150×φ13	1	把
36	ZQ3042RN	扩孔器	150×φ15	1	把
37	ZQ3043RN	扩孔器	200×φ5	1	把
38	ZQ3044RN	扩孔器	185×φ7	1	把
39	ZQ3045RN	扩孔器	170×φ9	1	把
40	ZQ3046RN	扩孔器	155×φ11	1	把
41	ZQ3047RN	扩孔器	140×φ13	1	把
42	ZQ3048RN	扩孔器	125×φ15	1	把
43	ZQ3049RN	扩孔器	200×φ7	1	把
44	ZQ3056RN	创口钩	50×12.5	1	把
45	ZQ3057RN	创口钩	60×12.5	1	把
46	ZQ3058RN	创口钩	70×12.5	1	把
47	ZQ3059RN	创口钩	80×12.5	1	把
48	ZQ3060RN	骨刮匙	260×6×45°, 反口	1	把
49	ZQ3061RN	双室漏斗	165×φ8	1	把
50	ZQ3062RN	植骨器	280×φ6.5	1	把

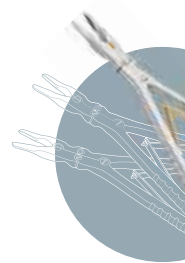

矫形外科(骨科)  
Orthopaedic Instruments

## 双通道脊柱手术器械推荐配置 Double Channel Spine Surgery Set

序号	产品编码	产品名称	规格型号	数量	单位
1	ZQ3001RN	ZQ3001RN 神经剥离器	230×5	1	把
2	ZQ3004RN	ZQ3004RN 骨锤	225/140g	1	把
3	ZQ3005RN	ZQ3005RN 骨刀	240	1	把
4	ZQ3090RN	ZQ3090RN 骨刀	245×5×15°，前弯	1	把
5	ZQ3091RN	ZQ3091RN 骨刀	245×5×30°，前弯	1	把
6	ZQ3007RN	ZQ3007RN 骨刀	250×5，右弯	1	把
7	ZQ3008RN	ZQ3008RN 骨刀	250×5，左弯	1	把
8	ZQ3092RN	ZQ3092RN 骨刀	250×4，直	1	把
9	ZQ3009RN	ZQ3009RN 骨刀	250×5，直	1	把
10	ZQ3093RN	ZQ3093RN 骨刀	250×6，直	1	把
11	ZQ3010RN	ZQ3010RN 骨刀	200×5，直	1	把
12	ZQ3011RN	ZQ3011RN 骨刀	200×5，弯	1	把
13	ZQ3094RN	ZQ3094RN 植骨器	235	1	把
14	ZQ3013RN	ZQ3013RN 骨刮匙	260×3×30°，前弯	1	把
15	ZQ3014RN	ZQ3014RN 骨刮匙	260×5×30°，前弯	1	把
16	ZQ3015RN	ZQ3015RN 骨刮匙	260×6×30°，前弯	1	把
17	ZQ3016RN	ZQ3016RN 骨刮匙	260×3×45°，反口	1	把
18	ZQ3095RN	ZQ3095RN 显微钩	230×5，单头	1	把
19	ZQ3096RN	ZQ3096RN 显微刀	230	1	把
20	ZQ3019RN	ZQ3019RN 骨膜剥离器	260×7×5°，弯	1	把
21	ZQ3020RN	ZQ3020RN 骨膜剥离器	260×7×25°，弯	1	把
22	ZQ3097RN	ZQ3097RN 骨膜剥离器	220×9×45°，弯，方头	1	把
23	ZQ3098RN	ZQ3098RN 神经根拉钩	195×4	1	把
24	ZQ3021RN	ZQ3021RN 神经根拉钩	195×4	1	把
25	ZQ3022RN	ZQ3022RN 神经根拉钩	195×6	1	把
26	ZQ3023RN	ZQ3023RN 神经根拉钩	195×8	1	把
27	ZQ3099RN	ZQ3099RN 骨膜剥离器	300×1，微弯	1	把
28	ZQ3300RN	ZQ3300RN 骨膜剥离器	300×1，深弯	1	把
29	ZQ3301RN	ZQ3301RN 骨膜剥离器	300×2，微弯	1	把
30	ZQ3302RN	ZQ3302RN 骨膜剥离器	300×2，深弯	1	把
31	ZQ3031RN	ZQ3031RN 骨膜剥离器	300×3，微弯	1	把
32	ZQ3032RN	ZQ3032RN 骨膜剥离器	300×3，深弯	1	把
33	ZQ3029RN	ZQ3029RN 骨膜剥离器	300×4，微弯	1	把
34	ZQ3030RN	ZQ3030RN 骨膜剥离器	300×4，深弯	1	把
35	ZQ3033RN	ZQ3033RN 吸引管	200×φ3，弯	1	把

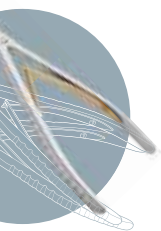

序号	产品编码	产品名称	规格型号	数量	单位
36	ZQ3305RN	ZQ3305RN 骨铰刀	230×4	1	把
37	ZQ3306RN	ZQ3306RN 骨铰刀	230×5	1	把
38	ZQ3307RN	ZQ3307RN 骨铰刀	230×6	1	把
39	ZQ3038RN	ZQ3038RN 骨铰刀	230×8	1	把
40	ZQ3040RN	ZQ3040RN 扩孔器	150×φ11	1	把
41	ZQ3041RN	ZQ3041RN 扩孔器	150×φ13	1	把
42	ZQ3042RN	ZQ3042RN 扩孔器	150×φ15	1	把
43	ZQ3043RN	ZQ3043RN 扩孔器	200×φ5	1	把
44	ZQ3044RN	ZQ3044RN 扩孔器	185×φ7	1	把
45	ZQ3045RN	ZQ3045RN 扩孔器	170×φ9	1	把
46	ZQ3046RN	ZQ3046RN 扩孔器	155×φ11	1	把
47	ZQ3049RN	ZQ3049RN 扩孔器	200×φ7	1	把
48	ZQ3308RN	ZQ3308RN 扩孔器	150×φ7	1	把
49	ZQ3309RN	ZQ3309RN 扩孔器	150×φ9	1	把
50	ZQ3056RN	ZQ3056RN 创口钩	50×12.5	1	把
51	ZQ3057RN	ZQ3057RN 创口钩	60×12.5	1	把
52	ZQ3058RN	ZQ3058RN 创口钩	70×12.5	1	把
53	ZQ3059RN	ZQ3059RN 创口钩	80×12.5	1	把
54	ZQ3060RN	ZQ3060RN 骨刮匙	260×6×45°, 反口	1	把
55	ZQ3061RN	ZQ3061RN 双室漏斗	165×φ8	1	把
56	ZQ3062RN	ZQ3062RN 植骨器	280×φ6.5	1	把
57	ZQ3311RN	ZQ3311RN 护套	φ7×40	1	把
58	ZQ3312RN	ZQ3312RN 护套	φ7×50	1	把
59	ZQ3313RN	ZQ3313RN 护套	φ7×60	1	把
60	ZF3084RN	ZF3084RN 椎板咬骨钳	230×2/10×130°, 可拆式	1	把
61	ZF3085RN	ZF3085RN 椎板咬骨钳	230×3/10×130°, 可拆式	1	把
62	ZF3086RN	ZF3086RN 椎板咬骨钳	230×2/10×130°, 可拆式, 弧形	1	把
63	ZF3087RN	ZF3087RN 椎板咬骨钳	230×3/10×130°, 可拆式, 弧形	1	把
64	ZF3088RN	ZF3088RN 椎板咬骨钳	230×4/10×130°, 可拆式	1	把
65	ZF3089RN	ZF3089RN 髓核钳	230×2, 直型, 指圈式	1	把
66	ZF3090RN	ZF3090RN 髓核钳	230×2×150°, 指圈式	1	把
67	ZF3074RN	ZF3074RN 髓核钳	220×3, 直型, 握柄式	1	把
68	ZF3075RN	ZF3075RN 髓核钳	220×3×150°, 握柄式	1	把
69	ZF3078RN	ZF3078RN 髓核钳	220×4, 直型, 握柄式	1	把

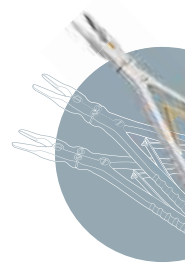

矫形外科(骨科)  
Orthopaedic Instruments



骨用牵开器 (ZV450RN)  
Bone Retractor

序号	产品编码	产品名称	规格型号	数量	单位
1	ZV451RN	软轴牵开器	740×Φ17.5	1	套
2	ZV453RN	骨用牵开器	130×57	1	套
3	ZV454RN	骨用牵开器	95×64	1	件
4	ZV455RN	扩孔器	140×Φ21.5	1	件
5	ZV456RN	扩孔器	150×Φ19	1	件
6	ZV457RN	扩孔器	160×Φ16	1	件
7	ZV458RN	扩孔器	170×Φ13	1	件
8	ZV459RN	扩孔器	180×Φ10	1	件
9	ZV460RN	扩孔器	190×Φ6.5	1	件
10	ZV461RN	扩孔器	234×Φ2	1	件

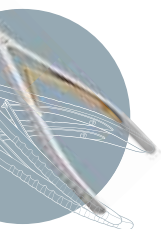

矫形外科  
(骨科)  
Orthopaedic Instruments

可扩张脊柱微创牵开系统





### 骨用牵开器 (ZV480RN) Bone Retractor

序号	产品编码	产品名称	规格型号	数量	单位
1	ZV451RN	软轴牵开器	740×Φ17.5	1	条
2	ZV481RN	椎间盘窥镜	Φ18×Φ14×40	1	件
3	ZV482RN	椎间盘窥镜	Φ18×Φ14×50	1	件
4	ZV483RN	椎间盘窥镜	Φ18×Φ14×60	1	件
5	ZV484RN	椎间盘窥镜	Φ22×Φ18×40	1	件
6	ZV485RN	椎间盘窥镜	Φ22×Φ18×50	1	件
7	ZV486RN	椎间盘窥镜	Φ22×Φ18×60	1	件
8	ZV487RN	椎间盘窥镜	Φ18×40	1	件
9	ZV488RN	椎间盘窥镜	Φ18×50	1	件
10	ZV489RN	椎间盘窥镜	Φ18×60	1	件
11	ZV490RN	椎间盘窥镜	Φ22×40	1	件
12	ZV491RN	椎间盘窥镜	Φ22×50	1	件
13	ZV492RN	椎间盘窥镜	Φ22×60	1	件
14	ZV493RN	扩孔器	150×Φ22	1	件
15	ZV494RN	扩孔器	160×Φ18	1	件
16	ZV495RN	扩孔器	170×Φ13	1	件
17	ZV496RN	扩孔器	230×Φ8	1	件

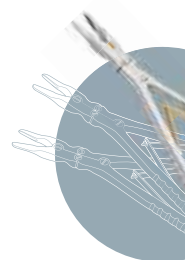

矫形外科(骨科)  
Orthopaedic Instruments

### 脊柱微创固定通道系统





### 显微脊柱手术器械 (ZF1170) Micro Spine Surgery Set

序号	产品编码	产品名称	规格型号	数量	单位
1	ZF4080RNh	椎板咬骨钳	230×1×130°, 偏体上弯	1	把
2	ZF4081RNh	椎板咬骨钳	230×2×130°, 偏体上弯	1	把
3	ZF4082RNh	椎板咬骨钳	230×3×130°, 偏体上弯	1	把
4	ZF4083RNh	椎板咬骨钳	230×2×130°, 偏体右弯	1	把
5	ZF4084RNh	椎板咬骨钳	230×2×130°, 偏体左弯	1	把
6	ZF4085RNh	髓核钳	150×2, 弯	1	把
7	ZF4086RNh	髓核钳	150×2, 直型	1	把
8	ZF4087RNh	髓核钳	180×1.6, 直型	1	把
9	ZF4088RNh	髓核钳	180×1.6, 弯	1	把
10	ZF4089RNh	吸引管	200×Φ2, 弯	1	支
11	ZF4090RNh	吸引管	200×Φ3, 弯	1	支
12	ZF4091RNh	吸引管	200×Φ3, 弯, 带剥离	1	支
13	ZF4092RNh	显微钩	270×Φ1.2×5, 枪型	1	把
14	ZF4093RNh	显微钩	270×Φ1.2×5, 枪型, 带槽	1	把
15	ZF4094RNh	显微钩	270×Φ2×6, 球头	1	把
16	ZF4095RNh	显微钩	260×5×1.4, 剥离	1	把
17	ZF4096RNh	骨刮匙	160×2, 直形, 枪型	1	把
18	ZF4097RNh	骨刮匙	160×2, 上弯, 枪型	1	把
19	ZF4098RNh	骨刮匙	160×2, 上弯, 反口, 枪型	1	把
20	ZB090RNh	手术刀柄	270, 枪形, 7#, 反向	1	把

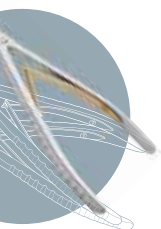

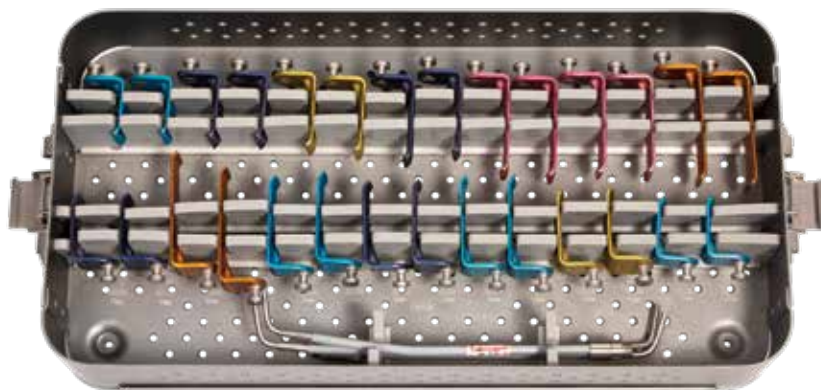

颈椎光源牵开器成套配置清单  
Cervical Light Source Retractor Set

序号	产品编码	产品名称	规格型号	数量	单位
1	JV470RN	拉钩	35×23, 带齿	2	把
2	JV471RN	拉钩	40×23, 带齿	2	把
3	JV472RN	拉钩	45×23, 带齿	2	把
4	JV473RN	拉钩	50×23, 带齿	2	把
5	JV474RN	拉钩	55×23, 带齿	2	把
6	JV475RN	拉钩	60×23, 带齿	2	把
7	JV476RN	拉钩	70×23, 带齿	2	把
8	JV477RN	拉钩	35×23	2	把
9	JV478RN	拉钩	40×23	2	把
10	JV479RN	拉钩	45×23	2	把
11	JV480RN	拉钩	50×23	2	把
12	JV481RN	拉钩	55×23	2	把
13	JV482RN	拉钩	60×23	2	把
14	JV483RN	拉钩	70×23	2	把

注：选配牵开臂 JV321T( 优先 ), JV322T, JV323T; 光纤 : ZV484R( 双头 ), ZV485R( 单头 ); 冷光源 : ZV486R。

Remark:JV321T(Priority),JV322T,JV323T;Optical Fiber:ZV484R(Double End),ZV485(Single End); Cold Light Source:ZV486R.

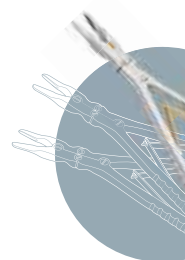

矫形外科(骨科)  
Orthopaedic Instruments

颈椎牵开器 (JV320)  
Cervical Retractor

★ JV321T 左侧



颈椎牵开器 (JV320)  
Cervical Retractor

★ JV322T 右侧

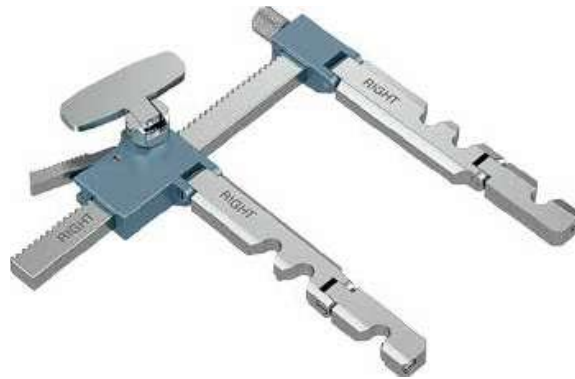

颈椎牵开器 (JV320)  
Cervical Retractor

★ JV323T 右侧

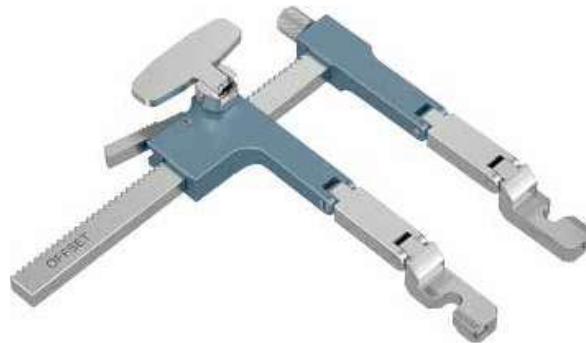

手柄  
Handle

★ JV324RB

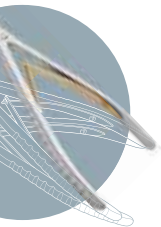

Orthopaedic Instruments  
矫形外科(骨科)



手柄  
Handle

★ JV325RN



拉钩  
Blade

- ★ JV326T 34x22.5, 有齿
- ★ JV327T 40x22.5, 有齿
- ★ JV328T 45x22.5, 有齿
- ★ JV329T 50x22.5, 有齿
- ★ JV330T 55x22.5, 有齿
- ★ JV331T 60x22.5, 有齿
- ★ JV332T 70x22.5, 有齿
- ★ JV333T 85x22.5, 有齿



拉钩  
Blade

- ★ JV334T 34x22.5, 无齿
- ★ JV335T 40x22.5, 无齿
- ★ JV336T 45x22.5, 无齿
- ★ JV337T 50x22.5, 无齿
- ★ JV338T 55x22.5, 无齿
- ★ JV339T 60x22.5, 无齿
- ★ JV340T 70x22.5, 无齿



拉钩  
Blade

- ★ JV341T 40x26.5, 有齿
- ★ JV342T 47x26.5, 有齿
- ★ JV343T 55x26.5, 有齿



拉钩  
Blade

- ★ JV344T 40x26.5, 无齿
- ★ JV345T 47x26.5, 无齿
- ★ JV346T 55x26.5, 无齿

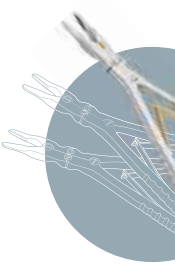

矫形外科(骨科)  
Orthopaedic Instruments

测深器  
Depth Gauge

★ JV347T



加长齿条  
Extension Radc

★ JV315T 160



拉钩  
Retractor

★ JV316T 尖型



拉钩  
Retractor

★ JV317T T型



拉钩  
Retractor

★ JV318T 椭圆型



锁紧器  
Locker

★ JV319T 33

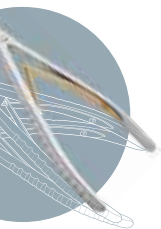

Orthopaedic Instruments  
矫形外科(骨科)

腰椎牵开器  
 Lumbar Retractor

★ JV351RNh



拉钩  
 Retractor

- ★ JV352RNh 30x20
- ★ JV353RNh 40x20
- ★ JV354RNh 50x20
- ★ JV355RNh 60x20
- ★ JV356RNh 70x20
- ★ JV357RNh 80x20



拉钩  
 Retractor

- ★ JV358RNh 30x27
- ★ JV359RNh 40x27
- ★ JV360RNh 50x27
- ★ JV361RNh 60x27
- ★ JV362RNh 70x27
- ★ JV363RNh 80x27



拉钩  
 Retractor

- ★ JV364RNh 20x2, 钩型, 有齿
- ★ JV365RNh 30x2, 钩型, 有齿
- ★ JV366RNh 40x2, 钩型, 有齿
- ★ JV367RNh 50x2, 钩型, 有齿
- ★ JV368RNh 60x2, 钩型, 有齿
- ★ JV369RNh 70x2, 钩型, 有齿



拉钩  
 Retractor

- ★ JV370RNh 20x1.8, 钩型, 无齿
- ★ JV371RNh 30x1.8, 钩型, 无齿
- ★ JV372RNh 40x1.8, 钩型, 无齿
- ★ JV373RNh 50x1.8, 钩型, 无齿
- ★ JV374RNh 60x1.8, 钩型, 无齿
- ★ JV375RNh 70x1.8, 钩型, 无齿

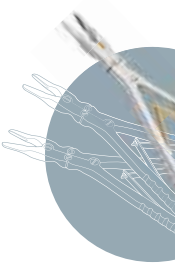

矫形外科(骨科)  
 Orthopaedic Instruments

碳纤维腰椎牵开器  
Lumbar Retractor Carbon Fiber

★ JV901P



拉钩  
Retractor

★ JV902P 40x20

★ JV903P 50x20

★ JV904P 60x20

★ JV905P 70x20



拉钩  
Retractor

★ JV906P 30x27

★ JV907P 40x27

★ JV908P 50x27

★ JV909P 60x27

★ JV910P 70x27

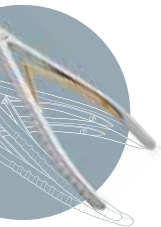

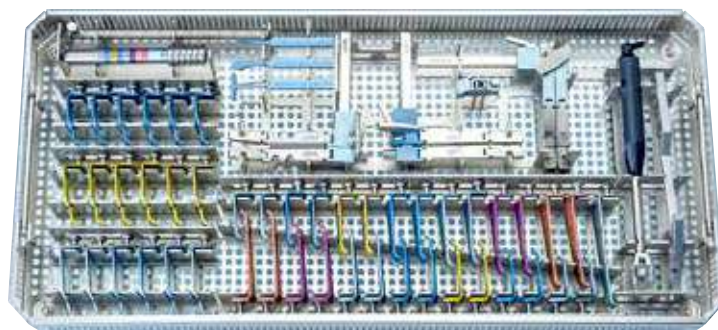

★ 颈椎牵开器 (JV320)  
Cervical Retractor Set ( JV320 )

序号	编 码	名 称	规 格	数量
1	JV321T	颈椎牵开器	左侧	1
2	JV322T	颈椎牵开器	右侧	1
3	JV323T	颈椎牵开器	右侧	1
4	JV324RB	手柄		1
5	JV325RN	手柄		1
6	JV326T	拉钩	34X22,5,有齿	2
7	JV327T	拉钩	40X22,5,有齿	2
8	JV328T	拉钩	45X22,5,有齿	2
9	JV329T	拉钩	50X22,5,有齿	2
10	JV330T	拉钩	55X22,5,有齿	2
11	JV331T	拉钩	60X22,5,有齿	2
12	JV332T	拉钩	70X22,5,有齿	2
13	JV333T	拉钩	85X22,5,有齿	1
14	JV334T	拉钩	34X22,5,无齿	2
15	JV335T	拉钩	40X22,5,无齿	2
16	JV336T	拉钩	45X22,5,无齿	2
17	JV337T	拉钩	50X22,5,无齿	2
18	JV338T	拉钩	55X22,5,无齿	2
19	JV339T	拉钩	60X22,5,无齿	2
20	JV340T	拉钩	70X22,5,无齿	2
21	JV341T	拉钩	40X26,5,有齿	4
22	JV342T	拉钩	47X26,5,有齿	4
23	JV343T	拉钩	55X26,5,有齿	4
24	JV344T	拉钩	40X26,5,无齿	2
25	JV345T	拉钩	47X26,5,无齿	2
26	JV346T	拉钩	55X26,5,无齿	2
27	JV347T	测深器		1
28	JV315T	加长齿条		1
29	JV316T	拉钩	尖型	1
30	JV317T	拉钩	T型	1
31	JV318T	拉钩	椭圆形	1
32	JV319T	锁紧器		1

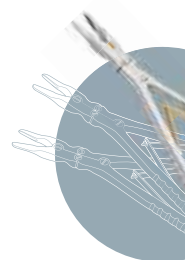

矫形外科(骨科)  
Orthopaedic Instruments



★ 腰椎牵开器 (JV350)  
Lumbar Retractor Set (JV350)

序号	编 码	名 称	规 格	数量
1	JV351RNh	腰椎牵开器		2
2	JV352RNh	拉钩	30X20	2
3	JV353RNh	拉钩	40X20	2
4	JV354RNh	拉钩	50X20	2
5	JV355RNh	拉钩	60X20	2
6	JV356RNh	拉钩	70X20	2
7	JV357RNh	拉钩	80X20	2
8	JV358RNh	拉钩	30X27	2
9	JV359RNh	拉钩	40X27	2
10	JV360RNh	拉钩	50X27	2
11	JV361RNh	拉钩	60X27	2
12	JV362RNh	拉钩	70X27	2
13	JV363RNh	拉钩	80X27	2
14	JV364RNh	拉钩	20X2,钩型,有齿	1
15	JV365RNh	拉钩	30X2,钩型,有齿	1
16	JV366RNh	拉钩	40X2,钩型,有齿	1
17	JV367RNh	拉钩	50X2,钩型,有齿	1
18	JV368RNh	拉钩	60X2,钩型,有齿	1
19	JV369RNh	拉钩	70X2,钩型,有齿	1
20	JV370RNh	拉钩	20X1.8,钩型,无齿	1
21	JV371RNh	拉钩	30X1.8,钩型,无齿	1
22	JV372RNh	拉钩	40X1.8,钩型,无齿	1
23	JV373RNh	拉钩	50X1.8,钩型,无齿	1
24	JV374RNh	拉钩	60X1.8,钩型,无齿	1
25	JV375RNh	拉钩	70X1.8,钩型,无齿	1

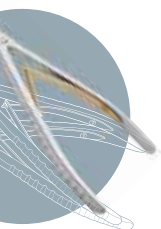

Orthopaedic Instruments  
矫形外科(骨科)



★ 碳纤维腰椎牵开器 (JV900)  
 Carbon Fiber Lumbar Retractor (JV900)

序号	编 码	名 称	规 格	数量
1	JV901P	腰椎牵开器		1
2	JV902P	拉钩	40X20	2
3	JV903P	拉钩	50X20	2
4	JV904P	拉钩	60X20	2
5	JV905P	拉钩	70X20	2
6	JV906P	拉钩	30X27	2
7	JV907P	拉钩	40X27	2
8	JV908P	拉钩	50X27	2
9	JV909P	拉钩	60X27	2
10	JV910P	拉钩	70X27	2

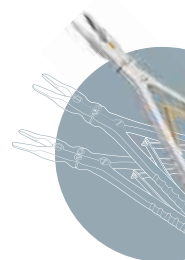

矫形外科(骨科)  
 Orthopaedic Instruments



### JZQ- I 型颈椎前路专用手术器械 (ZF108)

#### JZQ-I Anterior cervical surgery surgical instruments set

序号	编码	名称	规格	单位	数量
1	ZV405RN	颈椎牵开器	包含牵开器、牵开螺钉	套	1
2	ZF1026RNdh	椎板咬骨钳	230×1×90°, 普通型, 超硬膜	把	1
3	ZF687RNsh	椎板咬骨钳	230×2×110°, 普通型, 超硬膜	把	1
4	ZF693RNsh	椎板咬骨钳	230×2×130°, 普通型, 超硬膜	把	1
5	ZF1035RNdh	椎板咬骨钳	230×1×110°, 超薄型, 超硬膜	把	1
6	ZF488RNsh	椎板咬骨钳	230×2×130°, 超薄型, 超硬膜	把	1
7	ZF479RNsh	椎板咬骨钳	230×2×110°, 超薄型, 超硬膜	把	1
8	ZF890RNj	髓核钳(指圈式)	220×2	把	1
9	ZF982RNj	髓核钳(指圈式)	220×2×150°	把	1
10	ZF834RNj	髓核钳(指圈式)	220×3	把	1
11	ZF983RNj	髓核钳(指圈式)	220×3×150°	把	1
12	ZK589RNh	双关节咬骨钳	240×2×20°, 弯头	把	1
13	ZK593RNh	双关节咬骨钳	240×2×38°, 弯头	把	1
14	ZQ1025RN	骨刮匙(铝合金柄)	300×3×5°, 前弯	把	1
15	ZQ1026RN	骨刮匙(铝合金柄)	300×3×10°, 前弯	把	1
16	ZQ1033RN	骨刮匙(铝合金柄)	300×4×5°, 前弯	把	1
17	ZT596RN	颈椎S型拉钩	220×26×74	把	2
18	ZT533RN	颈椎拉钩	200×25×56, 大号	把	1
19	ZT532RN	颈椎拉钩	180×25×50, 小号	把	1
20	ZQ1258RN	带钩带槽神经剥离子	240×5×Φ0.8	把	2
21	ZQ775RN	薄型骨刀	200×3	把	1
22	ZQ776RN	薄型骨刀	200×4	把	1
23	ZQ777RN	薄型骨刀	200×5	把	1
24	ZQ779RN	薄型骨刀	200×8	把	1
25	ZQ924RN	锤骨器	210×Φ8	把	1

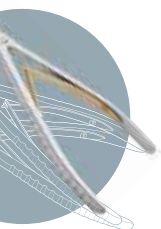



序号	编码	名称	规格	单位	数量
26	ZF1000RN	吸引管	260×Φ2	支	1
27	ZF921RN	吸引管	260×Φ3	支	1
28	ZF1005RN	吸引管	260×Φ4	支	1

JZQ- II 型颈椎前路专用手术器械 (ZF175)  
JZQ- II Anterior cervical surgery surgical instruments set

序号	编码	名称	规格	单位	数量
1	ZV405RN	颈椎牵开器	包含牵开器、牵开螺钉	套	1
2	ZF1026Rd	椎板咬骨钳	230×1×90°,普通型	把	1
3	ZF687Rs	椎板咬骨钳	230×2×110°,普通型	把	1
4	ZF693Rs	椎板咬骨钳	230×2×130°,普通型	把	1
5	ZF1035Rd	椎板咬骨钳	230×1×110°,超薄型	把	1
6	ZF488Rs	椎板咬骨钳	230×2×130°,超薄型	把	1
7	ZF479Rs	椎板咬骨钳	230×2×110°,超薄型	把	1
8	ZF890RNj	髓核钳(指圈式)	220×2	把	1
9	ZF982RNj	髓核钳(指圈式)	220×2×150°	把	1
10	ZF834RNj	髓核钳(指圈式)	220×3	把	1
11	ZF983RNj	髓核钳(指圈式)	220×3×150°	把	1
12	ZK589RNh	双关节咬骨钳	240×2×20°,弯头	把	1
13	ZK593RNh	双关节咬骨钳	240×2×38°,弯头	把	1
14	ZQ1025RN	骨刮匙(铝合金柄)	300×3×5°,前弯	把	1
15	ZQ1026RN	骨刮匙(铝合金柄)	300×3×10°,前弯	把	1
16	ZQ1033RN	骨刮匙(铝合金柄)	300×4×5°,前弯	把	1
17	ZT596RN	颈椎S型拉钩	220×26×74	把	2
18	ZT533RN	颈椎拉钩	200×25×56,大号	把	1
19	ZT532RN	颈椎拉钩	180×25×50,小号	把	1
20	ZQ1258RN	带钩带槽神经剥离子	240×5×Φ0.8	把	2
21	ZQ775RN	薄型骨刀	200×3	把	1
22	ZQ776RN	薄型骨刀	200×4	把	1
23	ZQ777RN	薄型骨刀	200×5	把	1
24	ZQ779RN	薄型骨刀	200×8	把	1
25	ZQ924RN	锤骨器	210×Φ8	把	1
26	ZF1000RN	吸引管	260×Φ2	支	1
27	ZF921RN	吸引管	260×Φ3	支	1
28	ZF1005RN	吸引管	260×Φ4	支	1

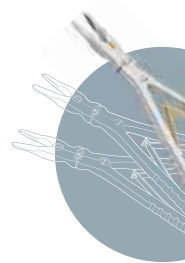

矫形外科(骨科)  
Orthopaedic Instruments

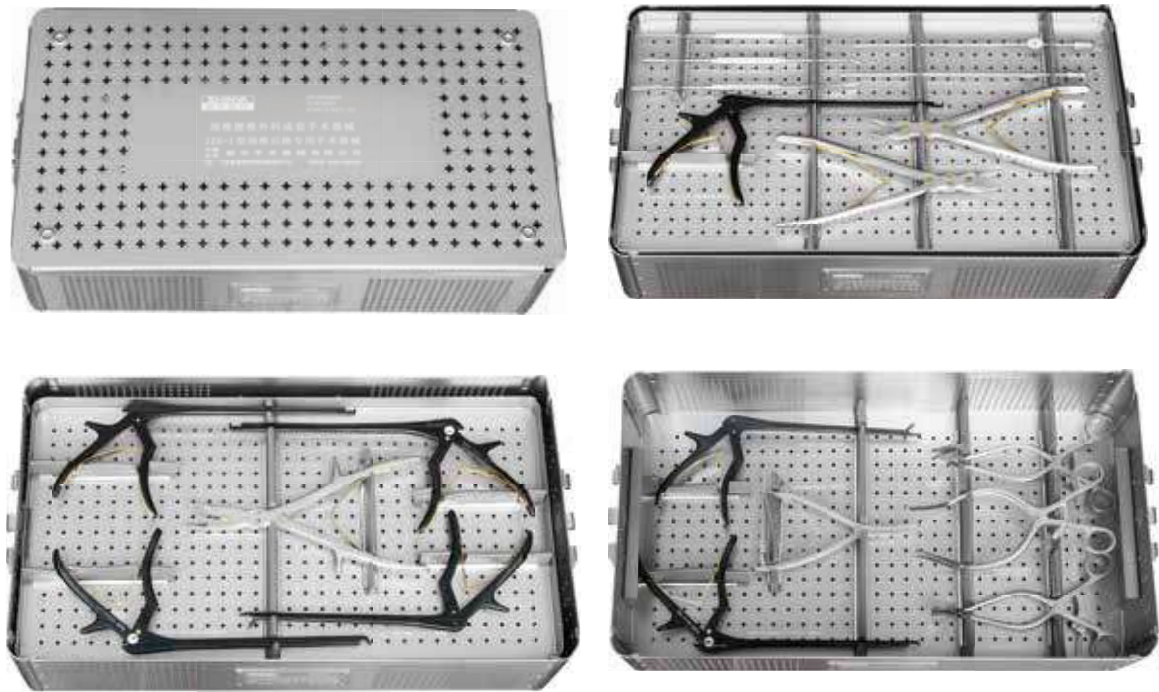

JZH- I 型颈椎后路专用手术器械 (ZF109)  
JZH-I posterior cervical surgical instruments set

序号	编码	名称	规格	单位	数量
1	ZF687RNsh	椎板咬骨钳	230×2×110°, 普通型, 超硬膜	把	1
2	ZF694RNsh	椎板咬骨钳	230×3×130°, 普通型, 超硬膜	把	1
3	ZF488RNsh	椎板咬骨钳	230×2×130°, 超薄型, 超硬膜	把	1
4	ZF480RNsh	椎板咬骨钳	230×3×110°, 超薄型, 超硬膜	把	1
5	ZF1035RNdh	椎板咬骨钳	230×1×110°, 超薄型, 超硬膜	把	1
6	ZK641RNh	双关节咬骨钳	240×3×20°, 弯尖头	把	1
7	ZK589RNh	双关节咬骨钳	240×2×20°, 弯头	把	1
8	ZF570RNdh	髓核钳(握柄式)	220×2×6, 超硬膜	把	1
9	ZF574RNdh	髓核钳(握柄式)	220×3×8, 超硬膜	把	1
10	ZK620RNj	双关节咬骨剪	240×30°, 弯	把	1
11	ZV266RN	后颅凹牵开器	200×18, 固定式4×4钩, 头弯45°	把	1
12	ZV267RN	后颅凹牵开器	200×30, 固定式4×4钩, 头弯45°	把	1
13	ZV265RN	后颅凹牵开器	200×60×8, 单钩, 头弯60°	把	2
14	ZQ960RN	颈椎后缘牵开器	180	把	1
15	ZQ755RN	神经剥离器	240×3	把	1
16	ZQ756RN	神经剥离器	240×5	把	1
17	ZQ1258RN	带钩带槽神经剥离器	240×5×Φ0.8	把	1
18	ZF921RN	吸引管	260×Φ3	把	1
19	ZF1005RN	吸引管	260×Φ4	把	1

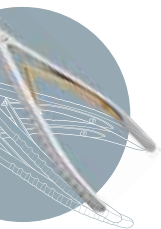

JZH- II 型颈椎后路专用手术器械 (ZF176)  
JZH- II posterior cervical surgical instruments set

序号	编码	名称	规格	单位	数量
1	ZF687Rs	椎板咬骨钳	230×2×110°, 普通型	把	1
2	ZF694Rs	椎板咬骨钳	230×3×130°, 普通型	把	1
3	ZF488Rs	椎板咬骨钳	230×2×130°, 超薄型	把	1
4	ZF480Rs	椎板咬骨钳	230×3×110°, 超薄型	把	1
5	ZF1035Rd	椎板咬骨钳	230×1×110°, 超薄型	把	1
6	ZK641RNh	双关节咬骨钳	240×3×20°, 弯尖头	把	1
7	ZK589RNh	双关节咬骨钳	240×2×20°, 弯头	把	1
8	ZF570Rd	髓核钳(握柄式)	220×2×6	把	1
9	ZF574Rd	髓核钳(握柄式)	220×3×8	把	1
10	ZK620RNj	双关节咬骨剪	240×30°, 弯	把	1
11	ZV266RN	后颅凹牵开器	200×18, 固定式4×4钩, 头弯45°	把	1
12	ZV267RN	后颅凹牵开器	200×30, 固定式4×4钩, 头弯45°	把	1
13	ZV265RN	后颅凹牵开器	200×60×8, 单钩, 头弯60°	把	2
14	ZQ960RN	颈椎后缘牵开器	180	把	1
15	ZQ755RN	神经剥离器	240×3	把	1
16	ZQ756RN	神经剥离器	240×5	把	1
17	ZQ1258RN	带钩带槽神经剥离器	240×5×Φ0.8	把	1
18	ZF921RN	吸引管	260×Φ3	把	1
19	ZF1005RN	吸引管	260×Φ4	把	1

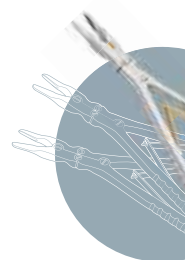

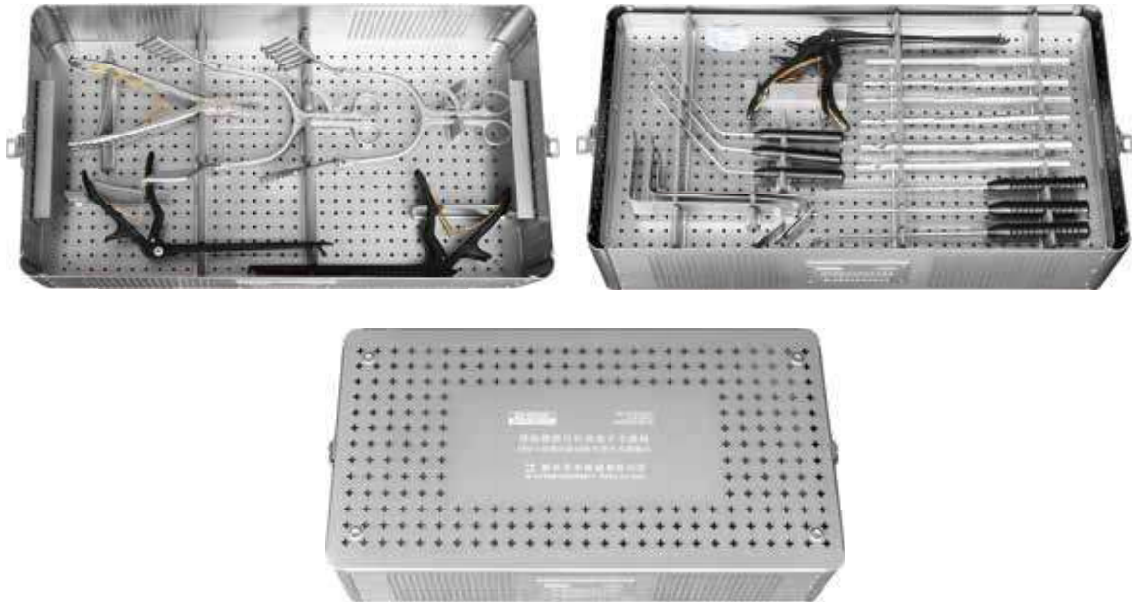

ZPQ- I 型椎间盘切除专用手术器械 (ZF171)  
ZPQ-I discectomy surgical instruments set

序号	编码	名称	规格	单位	数量
1	ZF688RNsh	椎板咬骨钳	230×3×110°, 普通型, 超硬膜	把	1
2	ZF695RNsh	椎板咬骨钳	230×4×130°, 普通型, 超硬膜	把	1
3	ZF489RNsh	椎板咬骨钳	230×3×130°, 超薄型, 超硬膜	把	1
4	ZF570RNdh	髓核钳(握柄式)	220×2×6, 超硬膜	把	1
5	ZF590RNdh	髓核钳(握柄式)	220×3×8×150°, 超硬膜	把	1
6	ZF582RNdh	髓核钳(握柄式)	220×5×12, 超硬膜	把	1
7	ZK590RNh	双关节咬骨钳	240×3×20°, 弯头	把	1
8	ZK591RNh	双关节咬骨钳	240×4×20°, 弯头	把	1
9	ZQ927RN	神经根拉钩	230×3×135°	把	1
10	ZQ928RN	神经根拉钩	230×5×135°	把	1
11	ZQ929RN	神经根拉钩	230×7×135°	把	1
12	ZQ705RN	髓核凿(骨刀)	235×Φ6	把	1
13	ZQ706RN	髓核凿(骨刀)	235×Φ8	把	1
14	ZQ707RN	髓核凿(骨刀)	235×Φ10	把	1
15	ZQ708RN	髓核凿(骨刀)	6.5×5.2, 椭圆	把	1
16	ZQ709RN	髓核凿(骨刀)	8.5×7.2, 椭圆	把	1
17	ZQ710RN	髓核凿(骨刀)	10.5×9.2, 椭圆	把	1
18	ZQ869RN	椎板拉钩	大, 175×28×100	把	1
19	ZQ965RN	椎板拉钩	中, 175×28×80	把	1
20	ZQ966RN	椎板拉钩	小, 175×25×60	把	1
21	ZV271RN	后颅凹牵开器	280×60, 活动式5×6钩(活节带齿)	把	2
22	ZQ1033RN	骨刮匙(铝合金柄)	300×4×5°, 前弯	把	1
23	ZQ1042RN	骨刮匙(铝合金柄)	300×5×10°, 前弯	把	1
24	ZQ1050RN	骨刮匙(铝合金柄)	300×6×10°, 前弯	把	1

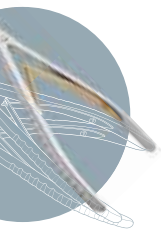

ZPQ- II 型椎间盘切除专用手术器械(ZF177)  
ZPQ- II discectomy surgical instruments set

序号	编码	名称	规格	单位	数量
1	ZF688Rs	椎板咬骨钳	230×3×110°,普通型	把	1
2	ZF695Rs	椎板咬骨钳	230×4×130°,普通型	把	1
3	ZF489Rs	椎板咬骨钳	230×3×130°,超薄型	把	1
4	ZF570Rd	髓核钳(握柄式)	220×2×6	把	1
5	ZF590Rd	髓核钳(握柄式)	220×3×8×150°	把	1
6	ZF582Rd	髓核钳(握柄式)	220×5×12	把	1
7	ZK590RNh	双关节咬骨钳	240×3×20°,弯头	把	1
8	ZK591RNh	双关节咬骨钳	240×4×20°,弯头	把	1
9	ZQ927RN	神经根拉钩	230×3×135°	把	1
10	ZQ928RN	神经根拉钩	230×5×135°	把	1
11	ZQ929RN	神经根拉钩	230×7×135°	把	1
12	ZQ705RN	髓核凿(骨刀)	235×Φ6	把	1
13	ZQ706RN	髓核凿(骨刀)	235×Φ8	把	1
14	ZQ707RN	髓核凿(骨刀)	235×Φ10	把	1
15	ZQ708RN	髓核凿(骨刀)	6.5×5.2,椭圆	把	1
16	ZQ709RN	髓核凿(骨刀)	8.5×7.2,椭圆	把	1
17	ZQ710RN	髓核凿(骨刀)	10.5×9.2,椭圆	把	1
18	ZQ869RN	椎板拉钩	大,175×28×100	把	1
19	ZQ965RN	椎板拉钩	中,175×28×80	把	1
20	ZQ966RN	椎板拉钩	小,175×25×60	把	1
21	ZV271RN	后颅凹牵开器	280×60,活动式5×6钩(活节带齿)	把	2
22	ZQ1033RN	骨刮匙(铝合金柄)	300×4×5°,前弯	把	1
23	ZQ1042RN	骨刮匙(铝合金柄)	300×5×10°,前弯	把	1
24	ZQ1050RN	骨刮匙(铝合金柄)	300×6×10°,前弯	把	1

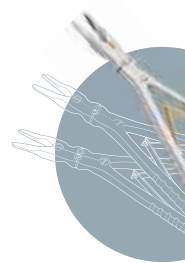

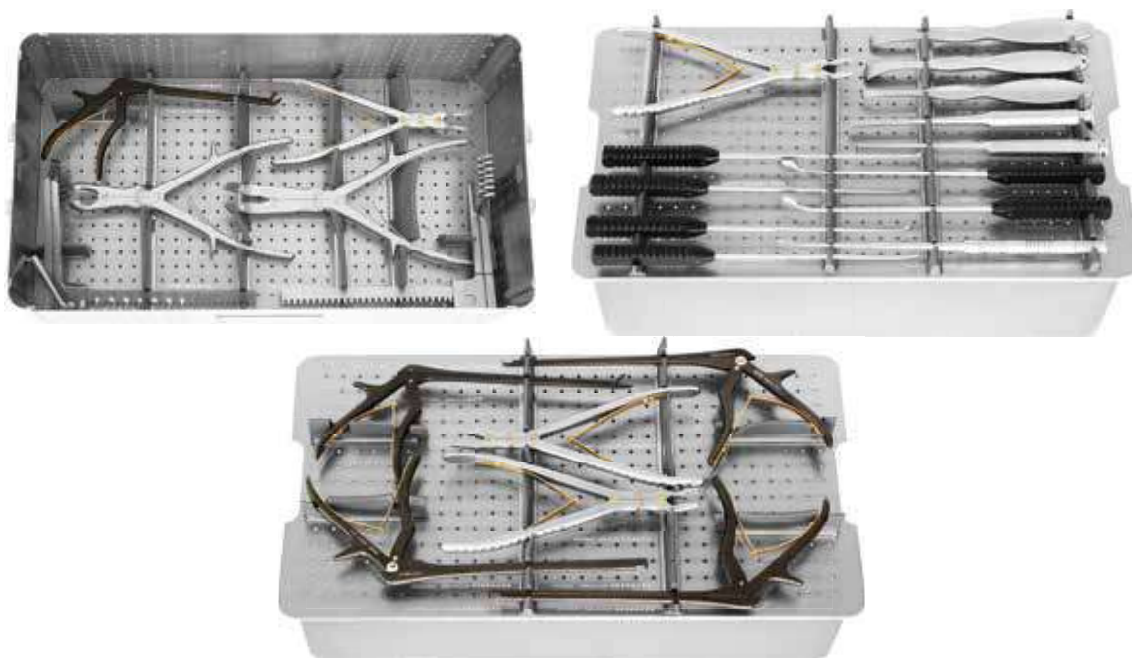

ZZH- I 型脊柱后路专用手术器械 (ZF173)  
ZZH-I posterior spine surgical instruments set

序号	编码	名称	规格	单位	数量
1	ZF688RNsh	椎板咬骨钳	230×3×110°,普通型,超硬膜	把	1
2	ZF1362RNsh	椎板咬骨钳	260×4×130°,普通型,超硬膜	把	1
3	ZF689RNsh	椎板咬骨钳	230×4×110°,普通型,超硬膜	把	1
4	ZF481RNsh	椎板咬骨钳	230×4×110°,超薄型,超硬膜	把	1
5	ZF1361RNsh	椎板咬骨钳	260×4×110°,超薄型,超硬膜	把	1
6	ZF489RNsh	椎板咬骨钳	230×3×130°,超薄型,超硬膜	把	1
7	ZK586RNh	双关节咬骨钳	240×3,直头	把	1
8	ZK590RNh	双关节咬骨钳	240×3×20°,弯头	把	1
9	ZK595RNh	双关节咬骨钳	240×4×38°,弯头	把	1
10	ZK641RNh	双关节咬骨钳	240×3×20°,尖头	把	1
11	ZF570RNdh	髓核钳(握柄式)	220×2×6,超硬膜	把	1
12	ZF574RNdh	髓核钳(握柄式)	220×3×8,超硬膜	把	1
13	ZF665RNdh	髓核钳(握柄式)	260×4×10×150°,超硬膜	把	1
14	ZF666RNdh	髓核钳(握柄式)	260×4×10,弧形,超硬膜	把	1
15	ZQ844RN	骨膜剥离器	220×10	把	1
16	ZQ845RN	骨膜剥离器	220×15	把	1
17	ZQ846RN	骨膜剥离器	220×20	把	1
18	ZQ783RN	骨膜分离器(铝合金柄)	300×Φ20,锐口	把	1
19	ZQ784RN	骨膜分离器(铝合金柄)	300×Φ20,钝口	把	1
20	ZQ1030RN	骨刮匙(铝合金柄)	300×4,直形	把	1
21	ZQ1033RN	骨刮匙(铝合金柄)	300×4×5°,前弯	把	1
22	ZQ1041RN	骨刮匙(铝合金柄)	300×5×5°,前弯	把	1
23	ZQ1042RN	骨刮匙(铝合金柄)	300×5×10°,前弯	把	1
24	ZQ373RN	薄型骨刀(六角柄)	240×8	把	1
25	ZQ375RN	薄型骨刀(六角柄)	240×12	把	1

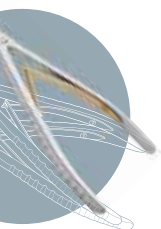

序号	编 码	名 称	规 格	单 位	数 量
26	ZQ1216RN	薄型骨刀	300×10	把	1
27	ZK565RN	双关节棘突咬骨剪	290×16	把	1
28	ZK564RN	双关节棘突咬骨钳	260×16	把	1
29	ZV714RN	脊柱深部牵开器	50×75,240×160,叶6×7齿	把	1
30	ZV715RN	脊柱深部牵开器	50×85,240×160,叶6×7齿	把	1

## ZZH- II 型脊柱后路专用手术器械(ZF178) ZZH- II posterior spine surgical instruments set

序号	编 码	名 称	规 格	单 位	数 量
1	ZF688Rs	椎板咬骨钳	230×3×110°,普通型	套	1
2	ZF1362Rs	椎板咬骨钳	260×4×130°,普通型	把	1
3	ZF689Rs	椎板咬骨钳	230×4×110°,普通型	把	1
4	ZF481Rs	椎板咬骨钳	230×4×110°,超薄型	把	1
5	ZF1361Rs	椎板咬骨钳	260×4×110°,超薄型	把	1
6	ZF489Rs	椎板咬骨钳	230×3×130°,超薄型	把	1
7	ZK586RNh	双关节咬骨钳	240×3,直头	把	1
8	ZK590RNh	双关节咬骨钳	240×3×20°,弯头	把	1
9	ZK595RNh	双关节咬骨钳	240×4×38°,弯头	把	1
10	ZK641RNh	双关节咬骨钳	240×3×20°,尖头	把	1
11	ZF570Rd	髓核钳(握柄式)	220×2×6	把	1
12	ZF574Rd	髓核钳(握柄式)	220×3×8	把	1
13	ZF665Rd	髓核钳(握柄式)	260×4×10×150°	把	1
14	ZF666Rd	髓核钳(握柄式)	260×4×10,弧形	把	1
15	ZQ844RN	骨膜剥离器	220×10	把	1
16	ZQ845RN	骨膜剥离器	220×15	把	1
17	ZQ846RN	骨膜剥离器	220×20	把	1
18	ZQ783RN	骨膜分离器(铝合金柄)	300×Φ20,锐口	把	1
19	ZQ784RN	骨膜分离器(铝合金柄)	300×Φ20,钝口	把	1
20	ZQ1030RN	骨刮匙(铝合金柄)	300×4,直形	把	1
21	ZQ1033RN	骨刮匙(铝合金柄)	300×4×5°,前弯	把	1
22	ZQ1041RN	骨刮匙(铝合金柄)	300×5×5°,前弯	把	1
23	ZQ1042RN	骨刮匙(铝合金柄)	300×5×10°,前弯	把	1
24	ZQ373RN	薄型骨刀(六角柄)	240×8	把	1
25	ZQ375RN	薄型骨刀(六角柄)	240×12	把	1
26	ZQ1216RN	薄型骨刀	300×10	把	1
27	ZK565RN	双关节棘突咬骨剪	290×16	把	1
28	ZK564RN	双关节棘突咬骨钳	260×16	把	1
29	ZV714RN	脊柱深部牵开器	50×75,240×160,叶6×7齿	把	1
30	ZV715RN	脊柱深部牵开器	50×85,240×160,叶6×7齿	把	1

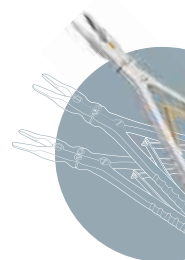

矫形外科(骨科)  
Orthopaedic Instruments

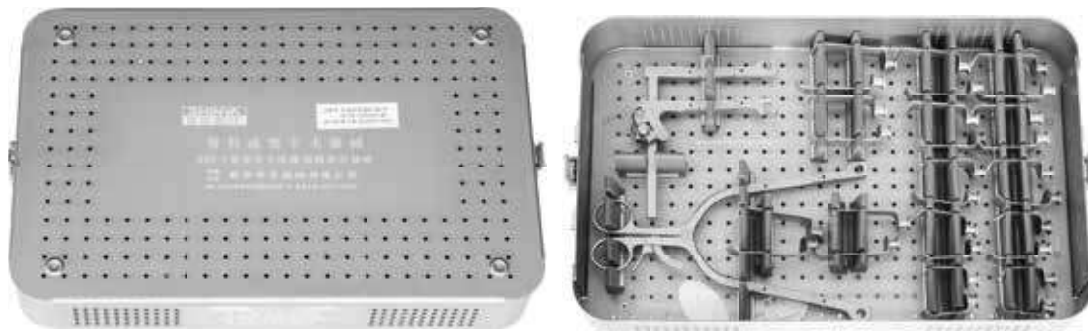

DJQ- I 型颈椎牵开手术器械包 (ZV570)  
DJQ-I multi-joint self retaining instruments set

序号	编 码	名 称	规 格	单 位	数 量
1	ZV410RN	颈椎三关节牵开器钳体	235	套	1
2	ZV407RN	颈椎牵开器	140×120, 齿条式(配14对拉钩)	套	1



SZG- I 型上肢手术器械 (ZK300)  
SZG-I surgical instruments set for upper limb

序号	编 码	名 称	规 格	单 位	数 量
1	ZQ852R	丝锥	HA3.5	把	1
2	ZQ899R	丝锥	HB4.0	把	1
3	ZQ900R	螺钉打滑器	SW2.5	把	1
4	LS023R	埋头钻	Φ6	把	1
5	ZK865R	空心钻	Φ4	把	1
6	ZQ902R	螺钉夹持器(钳)	HA3.5 - 4.5	把	1
7	ZQ840R	六角起子(内六角螺丝刀)(内六角改锥)	SW2.5	把	1
8	ZK165R	带尖复位钳	190	把	1

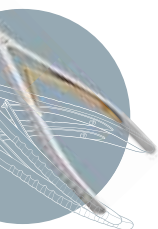

Orthopaedic Instruments  
矫形外科(骨科)



序号	编码	名称	规格	单位	数量
9	ZK164R	复位钳	170, 直头	把	1
10	ZK161R	中心化持骨钳(复位钳)	190	把	2
11	ZQ613R	测深器	60	把	1
12	ZK745R	导向器(护套, 钻套)	Φ2.5/3.5	把	1
13	ZK746R	导向器(护套, 钻套)	Φ3.2/4.0	把	1
14	LS325R	双头导钻(插入导钻)	Φ2.5	把	1
15	ZQ754R	骨撬(牵开器)	240×18, 平	把	1
16	ZQ580R	骨撬(牵开器)	240×42, 平	把	1
17	ZQ859R	骨板折弯器	左、右, 双槽200×3/4, 斜口, 单头	副	1
18	ZQ767R	骨膜剥离器	180×8 圆	把	1
19	ZQ688R	骨膜剥离器	180×12 平	把	1
20	ZK893R	骨钻	Φ2.5	支	2
21	ZK895R	骨钻	Φ3.2	支	2



SZG- II 型简易上肢手术器械 (ZK298)  
SZG- II simple surgical instruments set for upper limb

序号	编码	名称	规格	单位	数量
1	ZQ852R	丝锥	HA3.5	把	1
2	ZQ899R	丝锥	HB4.0	把	1
3	ZQ900R	螺钉打滑器	SW2.5	把	1
4	LS023R	埋头钻	Φ6	把	1
5	ZK865R	空心钻	Φ4	把	1
6	ZQ840R	六角起子(内六角螺丝刀)(内六方改锥)	SW2.5	把	1
7	ZQ613R	测深器	60	把	1
8	ZK745R	导向器(护套, 钻套)	Φ2.5/3.5	把	1
9	LS325R	双头导钻(插入导钻)	Φ2.5	把	1
10	ZQ859R	骨板折弯器	左、右, 双槽200×3/4, 斜口, 单头	副	1
11	ZQ688R	骨膜剥离器	180×12 平	把	1
12	ZK893R	骨钻	Φ2.5	支	2
13	ZK895R	骨钻	Φ3.2	支	2

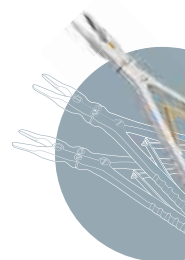

矫形外科(骨科)  
Orthopaedic Instruments

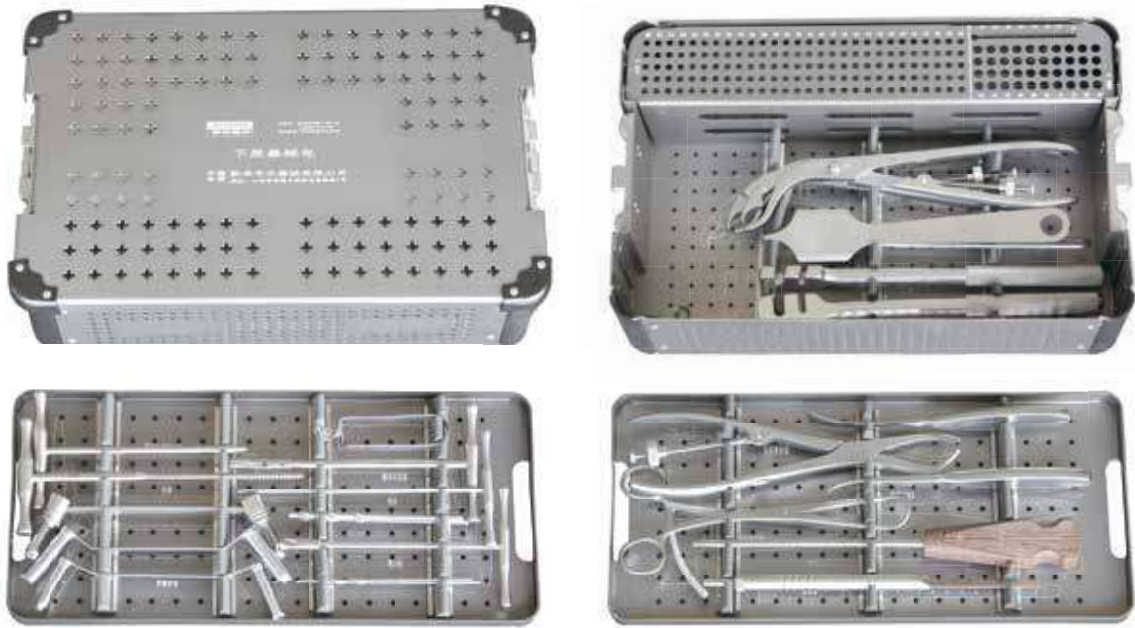

XZG- I 型下肢手术器械(ZK301)  
XZG-I surgical instruments set for lower limb

序号	编码	名称	规格	单位	数量
1	ZQ853R	丝锥	HA4.5	把	1
2	ZQ855R	丝锥	HB6.5	把	1
3	ZQ901R	螺钉打滑器	SW3.5	把	1
4	LS024R	埋头钻	Φ8	把	1
5	ZK867R	空心钻	Φ5	把	1
6	ZQ902R	螺钉夹持器(钳)	H3.5 - 4.5	把	1
7	ZQ841R	六角起子(内六角螺丝刀)(内六方改锥)	SW3.5	把	1
8	ZK166R	带尖复位钳	210	把	1
9	ZK163R	复位钳	230	把	1
10	ZK162R	中心化持骨钳(复位钳)	270	把	2
11	LS004R	测深器	90	把	1
12	ZK747R	导向器(护套, 钻套)	Φ3.2/4.5	把	1
13	ZK748R	导向器(护套, 钻套)	Φ4.5/6.5	把	1
14	LS033R	双头导钻(插入导钻)	Φ3.2	把	1
15	ZQ754R	骨撬(牵开器)	240×18, 平	把	1
16	ZQ580R	骨撬(牵开器)	240×42, 平	把	1
17	ZQ861R	骨板折弯器	左、右, 双槽280×5/6, 斜口, 单头	把	1
18	ZQ768R	骨膜剥离器	180×10 圆	把	1
19	ZQ770R	骨膜剥离器	180×15 平	把	1
20	ZK895R	骨钻	Φ3.2	支	2
21	ZK891R	骨钻	Φ4.5	支	2

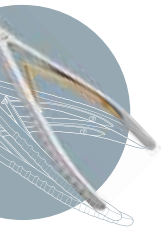



XZG- II 型简易下肢手术器械 (ZK299)  
XZG- II simple surgical instruments set for lower limb

序号	编码	名称	规格	单位	数量
1	ZQ853R	丝锥	HA4.5	把	1
2	ZQ855R	丝锥	HB6.5	把	1
3	ZQ901R	螺钉打滑器	SW3.5	把	1
4	LS024R	埋头钻	Φ8	把	1
5	ZK867R	空心钻	Φ5	把	1
6	ZQ841R	六角起子(内六角螺丝刀)(内六方改锥)	SW3.5	把	1
7	LS004R	测深器	90	把	1
8	ZK747R	导向器(护套, 钻套)	Φ3.2/4.5	把	1
9	LS033R	双头导钻(插入导钻)	Φ3.2	把	1
10	ZQ861R	骨板折弯器	左、右,双槽280×5/6,斜口,单头	副	1
11	ZQ770R	骨膜剥离器	180×15平	把	1
12	ZK895R	骨钻	Φ3.2	支	2
13	ZK891R	骨钻	Φ4.5	支	2

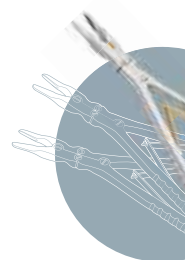

矫形外科(骨科)  
Orthopaedic Instruments



ZDS- I 型张力带钢丝专用手术器械 (ZS103)  
ZDS-I tension surgical instruments set with wire

序号	编码	名称	规格	单位	数量
1	ZK267R	克丝钳(钢丝钳)	200×Φ2, 尖头	把	1
2	ZK268R	克丝钳(钢丝钳)	200×Φ2, 虎头	把	1
3	ZK271R	紧丝钳		把	1
4	ZK272R	扎丝钳	245	把	1
5	ZK273R	钢针剪	200×Φ1.2	把	1
6	ZK274R	钢针剪	240×Φ2.5	把	1
7	ZK275R	钢针剪(钢丝剪)	350×(Φ1-Φ4)	把	1
8	ZK475R	钢针剪(钢丝剪)	240×Φ2.5 双面有刃	把	1
9	LS719R	大钢丝剪	500×Φ6, 手柄可拆	把	1
10	ZK278R	克氏剪	205×Φ3.5, 圆头	把	1
11	ZQ1148R	钢丝引导器(导丝器)	250×R23×48, 左弯	把	1
12	ZQ1149R	钢丝引导器(导丝器)	250×R23×48, 右弯	把	1
13	ZQ1150R	钢丝引导器(导丝器)	250×R23×48, 直型	把	1
14	ZQ1151R	空心钢丝引导器	225×R24×35, 直型	把	1
15	ZQ1152R	空心钢丝引导器	240×R30×50, 直型	把	1
16	ZK277R	钢丝缠绕器	255	把	1

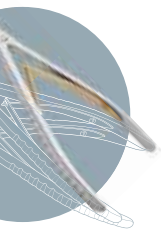

矫形外科(骨科)  
Orthopaedic Instruments



GPD- I 型骨盆骨折内固定专用手术器械 (ZS102)  
GPD-I internal fixation surgical instruments set for pelvic fractures

序号	编码	名称	规格	单位	数量
1	ZK173R	双爪复位钳	415	把	1
2	ZK174R	三爪复位钳	415	把	1
3	ZK175R	不对称双爪复位钳	415	把	1
4	ZK176R	弯头复位钳	240	把	1
5	ZK177R	弯头复位钳	270	把	1
6	ZK178R	直头复位钳	300	把	1
7	ZK179R	髌臼复位钳	340, 撑开及压缩两用	把	1
8	ZQ908R	双向弯曲钳	270	把	1
9	ZK158R	多齿持骨钳	200, 带自锁	把	1
10	ZQ957R	顶棒	300	把	1
11	ZQ629R	带尖活络座		只	2
12	ZQ627R	坐骨神经牵开器	310×30	把	1
13	ZQ863R	钢板折弯器	200, 双头, 左右	副	1

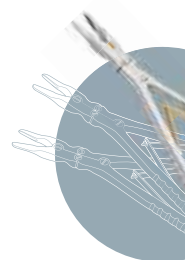

矫形外科(骨科)  
Orthopaedic Instruments

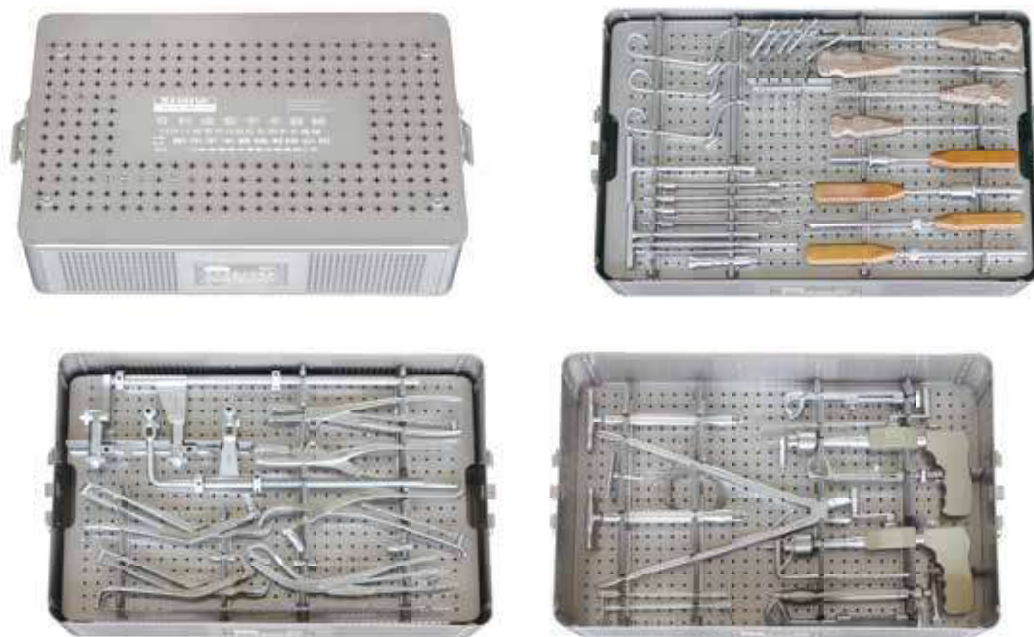

GND- I 型骨折内固定专用手术器械明细表 (ZS101)  
ND-I internal fixation surgical instruments set for pelvic fractures

序号	编码	名称	规格	单位	数量
1	ZK223R	导向持骨钳	小	把	1
2	ZK224R	导向持骨钳	中	把	1
3	ZK225R	导向持骨钳	大	把	1
4	ZK226R	三爪自定中心化持骨钳	250	把	1
5	ZQ235R	股骨撑开器	II型, 全长430	把	1
6	ZQ236R	股骨撑开器	I型, 全长350	把	1
7	ZK190R	骨把持器(骨折固定夹)	小	把	1
8	ZK191R	骨把持器(骨折固定夹)	中	把	1
9	ZK192R	骨把持器(骨折固定夹)	大	把	1
10	ZQ872R	断钉取出器(断螺钉拔出器)	HA3.5	把	1
11	ZQ898R	断钉取出器(断螺钉拔出器)	HA4.5	把	1
12	ZQ903R	断钉取出器(断螺钉拔出器)	HA6.5	把	1
13	ZQ237R	全自动保险起子	SW2.5	把	1
14	ZQ238R	全自动保险起子	SW3.5	把	1
15	ZQ241R	带套保险起子	SW2.5	把	2
16	ZQ242R	带套保险起子	SW3.5	把	2
17	ZQ243R	全自动保险起子	一字	把	2
18	ZQ722R	半月板钩	180×40×12	把	1
19	ZQ246R	半月板刀	左弯	把	1
20	ZQ247R	半月板刀	右弯	把	1
21	ZQ248R	半月板刀	直	把	1
22	ZK006R	手摇钻	夹持Φ6以下钻头	把	2
23	ZF870R	线锯条	500	包	1(20条装)

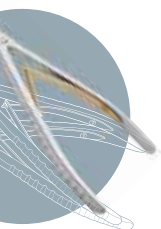

序号	编 码	名 称	规 格	单 位	数 量
23	ZF870R	线锯条	500	包	1(20条装)
24	ZF872R	线锯手柄	2×1	套	1
25	ZA807R	X射线摄影尺	200	把	1
26	ZA808R	X射线摄影尺	300	把	1
27	ZA809R	X射线摄影尺	400	把	1
28	ZK725R	软管钻钻头(分体型)	Φ2.5	支	1
29	ZK726R	软管钻钻头(分体型)	Φ3.2	支	1
30	ZK727R	软管钻钻头(分体型)	Φ3.5	支	1
31	ZK729R	软管钻钻头(分体型)	Φ4.5	支	1
32	ZK159R	多齿持骨钳	250, 带自锁	把	1
33	ZK141R	多齿持骨钳(不带齿条)	260	把	1
34	ZL878R	长肋骨剪	340	把	1
35	ZK733R	C形导钻	1#(35×Φ6 导钻架, Φ2.5, Φ3.5导钻头)	套	1
36	ZK734R	C形导钻	2#(42×Φ6导钻架, Φ3.2、Φ4.5导钻头)	套	1
37	ZK735R	C形导钻	3#(42×Φ8导钻架, Φ6.5导钻头)	套	1

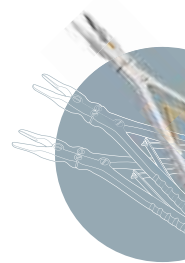

矫形外科(骨科)  
Orthopaedic Instruments



SND- I 型手指骨折内固定专用手术器械 (ZK101)  
SND-I internal fixation surgical instruments set for fingers

序号	编码	名称	规格	单位	数量
1	ZK576R	双关节咬骨钳	160×2×20°, 弯头	把	1
2	ZK683R	双关节咬骨钳	160×3×20°, 弯头	把	1
3	ZK614R	双关节咬骨剪	170, 弯	把	1
4	ZK227R	手指持骨钳	170	把	1
5	ZK228R	侧弯持骨钳	140	把	1
6	ZQ906R	螺钉夹持钳	HA2.0	把	1
7	ZQ249R	测深器	30	把	1
8	ZQ250R	一字起子	200	把	1
9	ZQ251R	内六角起子	200, SW2.0	把	1
10	ZQ849R	丝锥	HA2×135	把	1
11	ZQ632R	手指钢板弯曲器	120	把	2
12	ZK045R	骨锤	180/50g	把	1
13	ZQ790R	薄型骨刀	180×2	把	1
14	ZQ792R	薄型骨刀	180×4	把	1
15	ZQ794R	薄型骨刀	180×6	把	1
16	ZQ395R	骨刀	180×4, 直圆刃	把	1
17	ZQ633R	骨膜剥离器	160×5, 微弯	把	1
18	ZQ634R	骨膜剥离器	160×5, 深弯	把	1
19	ZQ635R	骨膜分离器	160×5, 微弯	把	1
20	ZQ636R	骨膜分离器	160×5, 深弯	把	1
21	ZQ637R	骨刮匙	160×2	把	1
22	ZQ638R	骨刮匙	160×3	把	1
23	ZQ639R	骨刮匙	160×4	把	1
24	ZK509R	指骨锉	190	把	1
25	ZQ640R	手钻	160×Φ1.6	把	1
26	ZQ641R	牵开拉钩	小, 直	把	1
27	ZQ642R	牵开拉钩	大, 直	把	1
28	ZQ643R	牵开拉钩	小, 弯	把	1
29	ZQ644R	牵开拉钩	大, 弯	把	1
30	ZK730R	不锈钢钻头	100×Φ1.5	支	3
31	ZK731R	不锈钢钻头	100×Φ1.8	支	3
32	ZQ907R	螺钉夹持镊	HA2.0	只	1

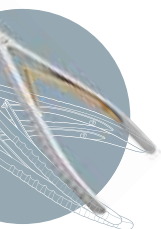

矫形外科 (骨科)  
Orthopaedic Instruments





JZZ- I 型脊柱植骨专用手术器械 (ZF172)  
JZZ-I Bone grafting surgical instruments set for spine

序号	编码	名称	规格	单位	数量
1	ZQ1270R	弯型漏斗	240×Φ6	把	1
2	ZQ1271R	弯型漏斗	270×Φ8	把	1
3	ZQ1272R	植骨推棒	245×Φ6	把	1
4	ZQ1273R	植骨推棒	245×Φ8	把	1
5	ZQ1274R	限位锥	220×Φ3.5	把	1
6	ZQ1275R	长十字锥	220×Φ4	把	1
7	ZQ1276R	短十字锥	215×Φ5	把	1

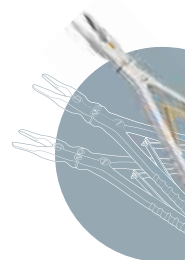

矫形外科(骨科)  
Orthopaedic Instruments



JQK- I 型颈椎牵开手术器械包 (ZV408)  
JQK- I self-retaining retractor for three cervical joints

序号	编码	名称	规格	单位	数量
1	ZV409R	双关节牵开器钳体	全长185	把	1
2	ZV410R	三关节牵开器钳体	全长235	把	1
3	ZV411R	牵开拉钩	30×16	片	2
4	ZV412R	牵开拉钩	40×16	片	2
5	ZV413R	牵开拉钩	50×16	片	2
6	ZV414R	牵开拉钩	60×16	片	2



BGD- I 型骨刀专用手术器械包 (ZK302)  
BGD- I thin osteotome instruments set

1	ZQ776R	薄型骨刀	200×4 (颈椎用)	把	1
2	ZQ778R	薄型骨刀	200×6 (颈椎用)	把	1
3	ZQ779R	薄型骨刀	200×8 (颈椎用)	把	1
4	ZQ790R	薄型骨刀	180×2 (手指用)	把	1
5	ZQ395R	骨刀	180×4, 直圆刃	把	1
6	ZQ1170R	平骨刀 (胶木柄)	300×8, 超薄斜刃	把	1
7	ZQ1171R	平骨刀 (胶木柄)	300×10, 超薄斜刃	把	1
8	ZQ1172R	平骨刀 (胶木柄)	300×12, 超薄斜刃	把	1
9	ZQ1226R	平骨刀 (胶木柄)	300×10, 短弧, 超薄斜刃	把	1
10	ZQ1218R	平骨刀 (胶木柄)	300×15, 短弧, 超薄斜刃	把	1
11	ZQ1194R	圆骨刀 (胶木柄)	260×9, 短弧, 圆口, 超薄刃	把	1
12	ZQ1189R	圆骨刀 (胶木柄)	260×12, 长弧, 圆口, 超薄刃	把	1
13	ZQ1237R	圆骨刀 (胶木柄)	260×12, 直圆头, 超薄刃	把	1
14	ZQ1200R	圆骨刀 (胶木柄)	260×15°×15, 前弯, 圆口, 超薄刃	把	1
15	ZQ1204R	圆骨刀 (胶木柄)	260×15°×12, 后弯, 圆口, 超薄刃	把	1
16	ZQ1210R	圆骨刀 (胶木柄)	260×10, 直平口, 超薄刃	把	1
17	ZQ1224R	圆骨刀 (胶木柄)	260×8, 枪形, 超薄斜刃	把	1
18	ZQ1225R	圆骨刀 (胶木柄)	260×10, 枪形, 超薄斜刃	把	1
19	ZQ437R	颈椎骨刀	220×9, 直平刃	把	1
20	ZQ1886R	鹅眉型骨凿 (扁胶木柄)	260×10, 直头平口	把	1

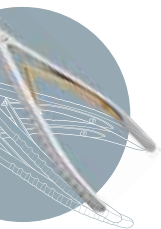



BGD- II 型骨刀专用手术器械包 (ZK303)  
BGD- II thin osteotome instruments set

1	ZQ776R	薄型骨刀	200×4 (颈椎用)	把	1
2	ZQ778R	薄型骨刀	200×6 (颈椎用)	把	1
3	ZQ779R	薄型骨刀	200×8 (颈椎用)	把	1
4	ZQ790R	薄型骨刀	180×2 (手指用)	把	1
5	ZQ395R	骨刀	180×4, 直圆刃	把	1
6	ZQ1600R	平骨刀	300×8, 超薄圆刃	把	1
7	ZQ1601R	平骨刀	300×10, 超薄圆刃	把	1
8	ZQ1602R	平骨刀	300×12, 超薄圆刃	把	1
9	ZQ1679R	平骨刀	300×10, 短弧, 超薄圆刃	把	1
10	ZQ1681R	平骨刀	300×15, 短弧, 超薄圆刃	把	1
11	ZQ1807R	圆骨刀	270×9, 短弧, 圆口, 超薄刃	把	1
12	ZQ1821R	圆骨刀	270×12, 长弧, 圆口, 超薄刃	把	1
13	ZQ1661R	圆骨刀	270×12, 直圆口, 超薄刃	把	1
14	ZQ1750R	圆骨刀	270×15×15°, 圆口, 超薄刃, 前弯	把	1
15	ZQ1761R	圆骨刀	270×12×15°, 圆口, 超薄刃, 后弯	把	1
16	ZQ1840R	圆骨刀	270×10, 直平口, 超薄刃	把	1
17	ZQ1785R	圆骨刀	270×8, 梯形, 圆口, 超薄刃	把	1
18	ZQ1786R	圆骨刀	270×10, 梯形, 圆口, 超薄刃	把	1
19	ZQ437R	颈椎骨刀	220×9, 直平刃	把	1
20	ZQ1886R	鹅眉型骨凿(扁胶木柄)	260×10, 直头平口	把	1

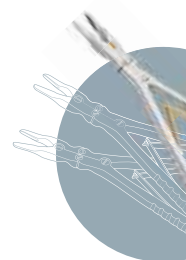

矫形外科(骨科)  
Orthopaedic Instruments



NQD - I 型内固定取(断)钉手术器械 (ZQ1400)  
NQD-I internal fixation surgical instruments set for nail taking

序号	编码	名称	规格	单位	数量
1	ZQ2076RN	剥离钩	160×R6×10, 锐	支	1
2	ZQ1947RN	换柄式铰刀	150, 三角刃长20	支	1
3	ZQ2079RN	换柄式六角起子	90×Sw1.5	支	1
4	ZQ2080RN	换柄式六角起子	90×Sw2.0	支	1
5	JQ2081RN	换柄式六角起子	90×Sw2.5	支	2
6	ZQ2082RN	换柄式六角起子	90×Sw3.0	支	1
7	JQ2083RN	换柄式六角起子	90×Sw3.5	支	1
8	ZQ2084RN	换柄式六角起子	90×Sw4.0	支	1
9	ZQ2085RN	换柄式六角起子	90×Sw4.5	支	1
10	ZQ2086RN	换柄式六角起子	90×Sw5.0	支	1
11	ZQ2087RN	换柄式六角起子	90×Sw5.5	支	1
12	JQ2092RN	换柄式四方起子	90×Sw1.2	支	1
13	JQ2093RN	换柄式四方起子	90×Sw1.5	支	1
14	ZQ2100RN	换柄式一字起子	90×0.5×3	支	1
15	ZQ2101RN	换柄式一字起子	90×0.6×6	支	1
16	JQ2108RN	换柄式十字起子	90×0.4×2	支	1
17	ZQ1335RN	换柄式U型上钉器	90×R2.5×11	支	1
18	ZQ2115RN	换柄式断钉拔出(取出)器	195×H3.5	把	1
19	ZQ2116RN	换柄式断钉拔出(取出)器	195×H4.5	把	1
20	ZQ2121RN	断钉拔出钳	200, 夹持H3-5	把	1

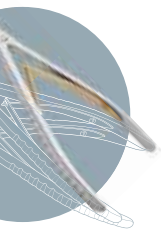

序号	编码	名称	规格	单位	数量
21	JQ2127RN	换柄式梅花起子	90×T8	支	1
22	JQ2129RN	换柄式梅花起子	90×T10	支	2
23	JQ2130RN	换柄式梅花起子	90×T15	支	1
24	ZQ2131RN	换柄式梅花起子	90×T20	支	1
25	JQ2132RN	换柄式梅花起子	90×T25	支	1
26	ZQ2134RN	换柄式梅花起子	90×T30	支	1
27	ZQ2144RN	硬质合金钻头	80×Φ5	支	1
28	ZQ2147RN	硬质合金钻头	80×Φ6	支	1
29	ZQ2150RN	硬质合金钻头	80×Φ7	支	1
30	ZQ2154RN	螺钉打滑取出器	90×Sw2.5	支	1
31	ZQ2156RN	螺钉打滑取出器	90×Sw3.5	支	1
32	ZQ2157RN	螺钉打滑取出器	90×Sw4.0	支	1
33	ZQ1240RN	圆骨刀 (铝合金柄)	200×8, 直, 圆刃	把	1
34	ZQ2161RN	换柄式空心钻	90×H2.0	支	1
35	ZQ2164RN	换柄式空心钻	90×H2.7	支	1
36	ZQ2168RN	换柄式空心钻	150×H4.0	支	1
37	ZQ2171RN	换柄式空心钻	150×H5.0	支	1
38	ZQ2174RN	换柄式空心钻	150×H6.5	支	1
39	ZQ2177RN	换柄式空心钻	150×H8.0	支	1
40	ZQ2180RN	换柄式取钉环钻	90×4.0	支	1
41	ZQ2182RN	换柄式取钉环钻	90×5.0	支	1
42	ZQ2185RN	换柄式取钉环钻	90×6.5	支	1
43	ZQ2188RN	直型快换手柄	160	把	1
44	ZQ2189RN	T型快换手柄	100	把	1

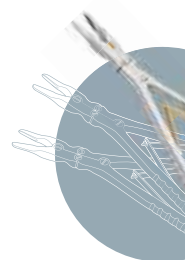

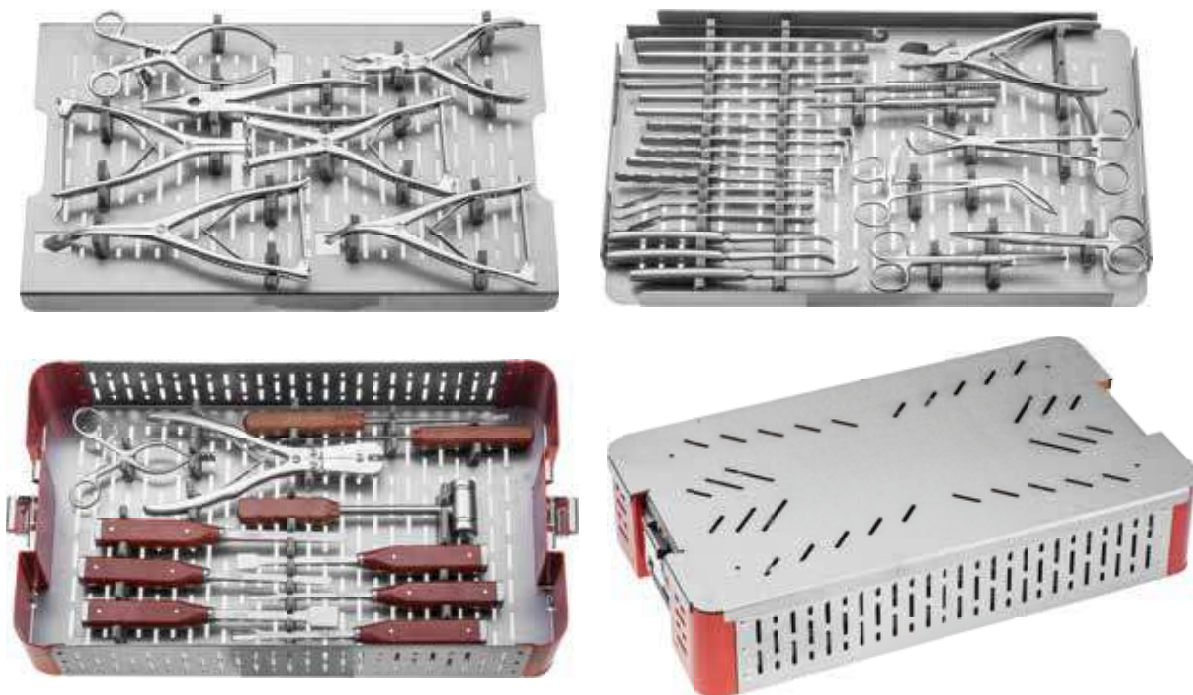

ZHQ- I 型 足踝手术器械包 (ZK305)  
ZHQ-I ankle surgical instruments set

序号	编码	名称	规格	单位	数量
1	LS059R	医用尺	200	把	1
2	ZQ2800RB	骨刀	200×20	把	1
3	ZQ2801RB	骨刀	200×15	把	1
4	ZQ2802RB	骨刀	200×10	把	1
5	ZQ2803RB	骨刀	160×8	把	1
6	ZQ2804RB	骨刀	160×6	把	1
7	ZQ2805RB	骨刀	160×4	把	1
8	ZT128R	皮肤拉钩	175×19×16, 四齿	把	1
9	ZT129R	皮肤拉钩	175×19×11, 三齿	把	1
10	ZT130R	皮肤拉钩	175×19×6, 二齿	把	1
11	ZT131R	皮肤拉钩	175×19×6.5	把	1
12	ZT132R	皮肤拉钩	180×7.5×4.5, 二齿	把	1
13	ZT563R	骨撬	165×6.5	把	1
14	ZT564R	骨撬	165×9	把	1
15	ZT565R	骨撬	165×15	把	1
16	ZQ993RN	骨膜剥离器	190×15, 平刃	把	1
17	ZQ994RN	骨膜剥离器	190×10, 平刃	把	1
18	ZQ995RN	骨膜剥离器	190×8, 圆刃	把	1
19	ZK622R	咬骨剪	180, 直	把	1
20	ZQ922RB	锤骨器	160×Φ4	把	1
21	ZQ923RB	锤骨器	160×Φ8	把	1
22	ZK165R	复位钳	190mm	把	1
23	ZK187R	足踝持骨钳	165mm	把	1

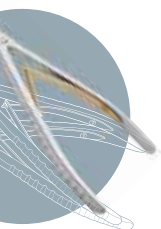

序号	编码	名称	规格	单位	数量
24	ZC545RBr	组织剪	160直	把	1
25	ZC555RBr	组织剪	160弯	把	1
26	ZQ1324R	足踝撑开器	230×16	把	1
27	ZQ1326R	足踝撑开器	180×7.5	把	1
28	ZQ1325R	足踝克什针撑开器	170×40, 双孔	把	1
29	ZQ1545R	压缩钳	180×40, 双孔	把	1
30	ZK267R	克丝(氏)钳	200×Φ2, 尖头	把	1
31	ZK576R	咬骨钳	160×2×20°, 弯头	把	1
32	ZV298R	椎板牵开器	165×18, 单钩	把	1
33	ZV081R	乳突牵开器	165×16, 2×3钩	把	1
34	ZQ1338RB	骨刮匙	240×3, 胶木柄	把	1
35	ZQ1339RB	骨刮匙	240×5, 胶木柄	把	1
36	ZK475R	钢针剪	240×Φ2.5, 双面有刃	把	1
37	ZQ297R	骨锤	230/250g, 胶木柄	把	1
38	ZQ2806RB	骨刀(胶木柄)	240×8, 直刃	把	1
39	ZQ2807RB	骨刀(胶木柄)	240×10, 直刃	把	1
40	ZQ2808RB	骨刀(胶木柄)	240×15, 直刃	把	1
41	ZQ2809RB	骨刀(胶木柄)	240×20, 直刃	把	1
42	ZQ2810RB	骨刀(胶木柄)	240×12, 圆刃	把	1
43	ZQ2811RB	骨刀(胶木柄)	240×12, 圆刃	把	1

