

基础器械  
Standard Instruments

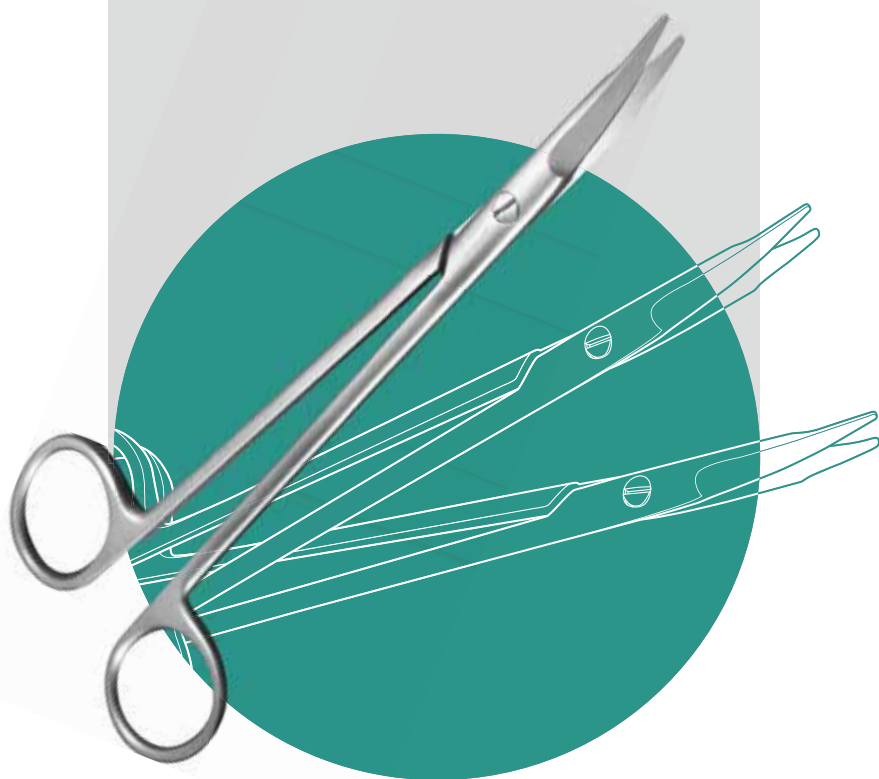

QUALITY  
OUR WAY TO SUCCESS

Standard Instruments

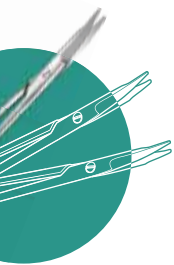

基础器械  
Standard Instruments



手术刀柄  
Handle

★ **ZB073R/RN**  
3# (长度125mm)



手术刀柄  
Handle

★ **ZB084R/RN**  
4# (长度140mm)



手术刀柄  
Handle

★ **ZB077R/RN**  
7# (长度160mm)



手术刀柄  
Handle

★ **ZB079RN**  
9# (长度125mm)

3#、7#、9#、3L#手术刀柄与9#-17#手术刀片配合使用 4#、4L#手术刀柄与20#-39#手术刀片配合使用  
3#,7#,9#,3L# for blade NO.9#-17#, 4#,4L# for blade NO. 20#-39#.

编码后缀注释: R—电镀 RN—亚光无镀层 Note: R-chrome plated RN-sand blasted matt surface



手术刀柄  
Handle

★ **ZB074RG**  
3L# (长度200mm)



手术刀柄  
Handle

★ **ZB085RN**  
4L# (长度220mm)



手术刀柄  
Handle, Upwards  
Curved

★ **ZB071RN**  
180, 上弯 (长度180mm)



手术刀柄  
Handle, Downwards  
curved

★ **ZB072RN**  
180, 下弯 (长度180mm)



基础器械  
Standard Instruments

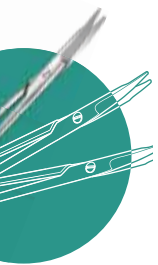

基础器械  
 Standard Instruments

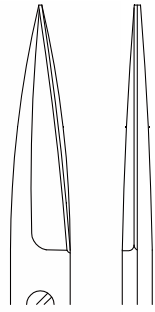
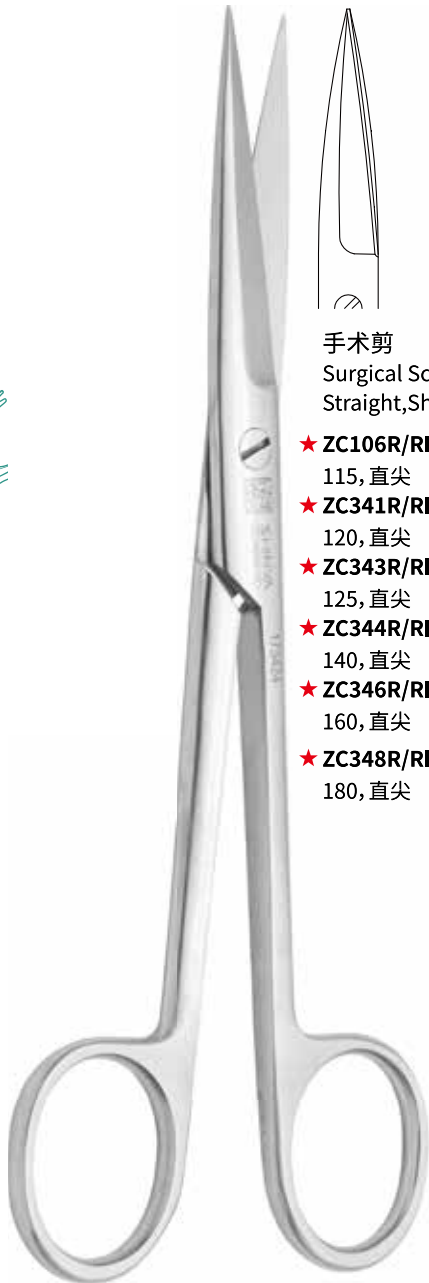

手术剪  
 Surgical Scissors  
 Straight, Sharp

- ★ ZC106R/RN  
115, 直尖
- ★ ZC341R/RN  
120, 直尖
- ★ ZC343R/RN  
125, 直尖
- ★ ZC344R/RB  
140, 直尖
- ★ ZC346R/RB  
160, 直尖
- ★ ZC348R/RB  
180, 直尖

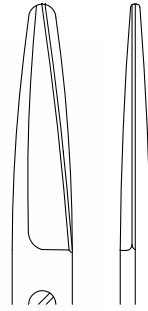

手术剪  
 Surgical Scissors  
 straight, blunt

- ★ ZC120R/RN  
115, 直圆
- ★ ZC313R/RN  
125, 直圆
- ★ ZC314R/RB  
140, 直圆
- ★ ZC316R/RB  
160, 直圆
- ★ ZC318R/RB  
180, 直圆

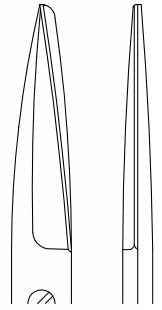

手术剪  
 Surgical Scissors  
 Straight, Sharp/blunt

- ★ ZC112R/RN  
115, 直尖圆
- ★ ZC323R/RN  
125, 直尖圆
- ★ ZC324R/RB  
140, 直尖圆
- ★ ZC326R/RB  
160, 直尖圆
- ★ ZC328R/RB  
180, 直尖圆

编码后缀注释: R—电镀 RN—亚光无镀层 RB—刷光无镀层 Note: R-chrome plated RN-sand blasted matt surface RB-brushed matt surface



手术剪  
Surgical Scissors  
Curved,Sharp

- ★ ZC121R/RN  
115, 弯尖
- ★ ZC441R/RN  
120, 弯尖
- ★ ZC443R/RN  
125, 弯尖
- ★ ZC444R/RB  
140, 弯尖
- ★ ZC446R/RB  
160, 弯尖
- ★ ZC448R/RB  
180, 弯尖



手术剪  
Surgical Scissors  
Curved,Blunt

- ★ ZC135R/RN  
115, 弯圆
- ★ ZC413R/RN  
125, 弯圆
- ★ ZC414R/RB  
140, 弯圆
- ★ ZC416R/RB  
160, 弯圆
- ★ ZC418R/RB  
180, 弯圆



手术剪  
Surgical Scissors  
Curved,sharp/blunt

- ★ ZC113R/RN  
115, 弯尖圆
- ★ ZC423R/RN  
125, 弯尖圆
- ★ ZC424R/RB  
140, 弯尖圆
- ★ ZC426R/RB  
160, 弯尖圆
- ★ ZC428R/RB  
180, 弯尖圆



基础器械  
Standard Instruments

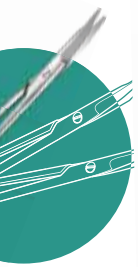

基础器械  
 Standard Instruments

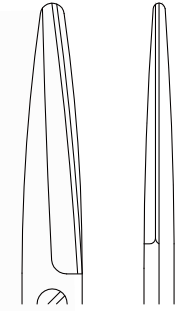

组织剪  
 Mayo Dissecting Scissors  
 Straight

- ★ ZC544R/RB  
140, 直
- ★ ZC545R/RB  
160, 直
- ★ ZC547R/RB  
180, 直
- ★ ZC548R/RB  
200, 直
- ★ ZC549R/RB  
220, 直
- ★ ZC550R/RB  
250, 直

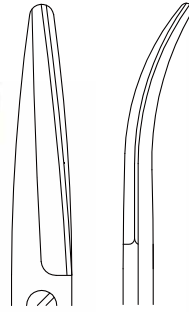

组织剪  
 Mayo Dissecting Scissors  
 Curved

- ★ ZC554R/RB  
140, 弯
- ★ ZC555R/RB  
160, 弯
- ★ ZC557R/RB  
180, 弯
- ★ ZC558R/RB  
200, 弯
- ★ ZC559R/RB  
220, 弯
- ★ ZC560R/RB  
250, 弯

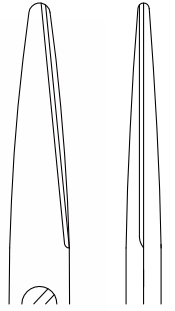

综合组织剪  
 Metzenbaum Tissue  
 Scissors Straight

- ★ ZC639R/RB  
160, 直
- ★ ZC642R/RB  
180, 直
- ★ ZC643R/RB  
200, 直
- ★ ZC644R/RB  
220, 直
- ★ ZC645R/RB  
250, 直

编码后缀注释: R—电镀 RB—刷光无镀层 Note: R-chrome plated RB: brushed surface

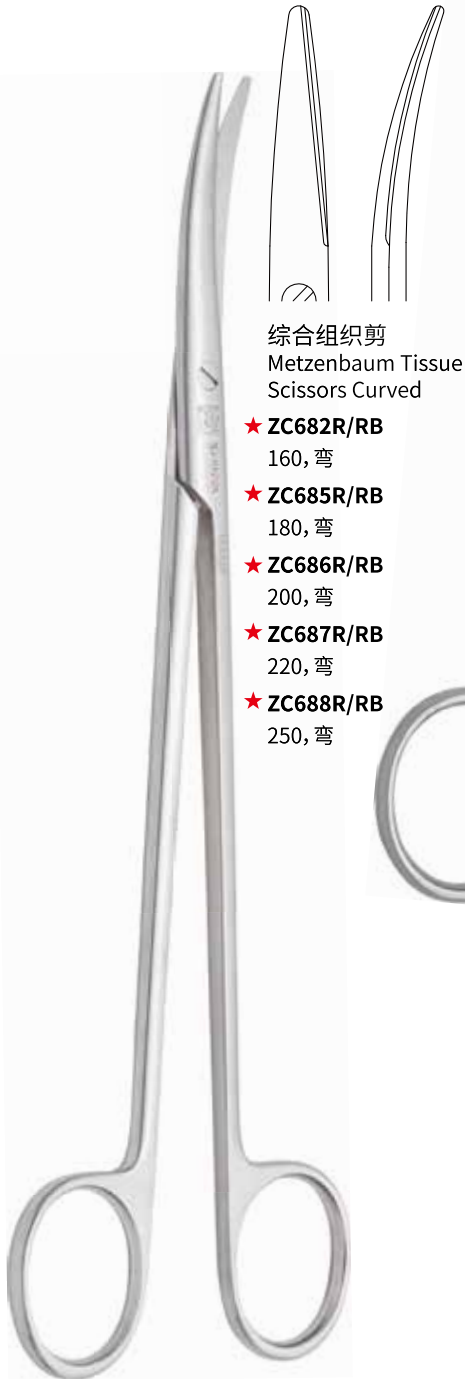

综合组织剪  
Metzenbaum Tissue  
Scissors Curved

- ★ ZC682R/RB  
160, 弯
- ★ ZC685R/RB  
180, 弯
- ★ ZC686R/RB  
200, 弯
- ★ ZC687R/RB  
220, 弯
- ★ ZC688R/RB  
250, 弯



纱布绷带剪  
Bandage Scissors

- ★ ZC862R  
180, 全球头



拆线剪  
Littauer Ligature Scissors

- ★ ZC803R/RB  
140×28
- ★ ZC804R/RB  
140×40
- ★ ZC808R/RB  
160×45

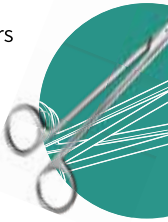

基础器械  
Standard Instruments

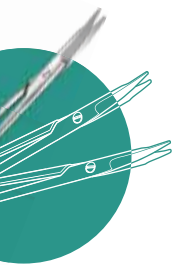

基础器械  
 Standard Instruments



① 精细手术剪 (解剖剪)  
 Delicate Scissors Straight/Sharp

- ★ ZC049RN/RNj  
125, 直尖, 解剖型
- ★ ZC051RN/RNj  
145, 直尖, 解剖型



① 精细手术剪 (解剖剪)  
 Delicate Scissors Curved/Sharp

- ★ ZC050RN/RNj  
125, 弯尖, 解剖型
- ★ ZC052RN/RNj  
145, 弯尖, 解剖型

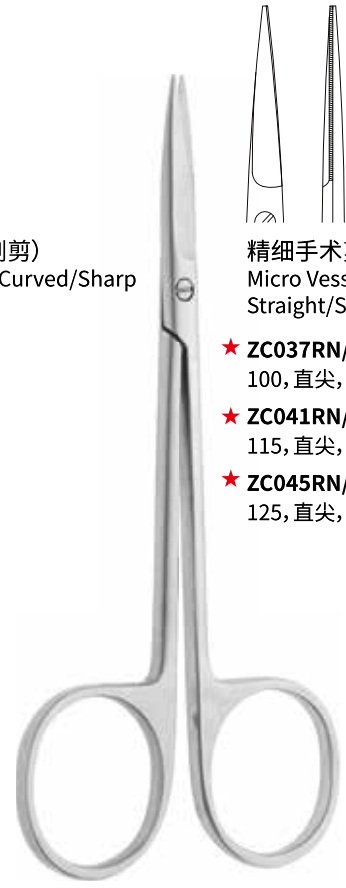

精细手术剪 (小血管剪)  
 Micro Vessel Scissors  
 Straight/Sharp

- ★ ZC037RN/RNj  
100, 直尖, 小血管
- ★ ZC041RN/RNj  
115, 直尖, 小血管
- ★ ZC045RN/RNj  
125, 直尖, 小血管



① 精细手术剪 (小血管剪)  
 Micro Vessel Scissors  
 Straight, Blunt

- ★ ZC038RN/RNj  
100, 直圆, 小血管
- ★ ZC042RN/RNj  
115, 直圆, 小血管
- ★ ZC046RN/RNj  
125, 直圆, 小血管

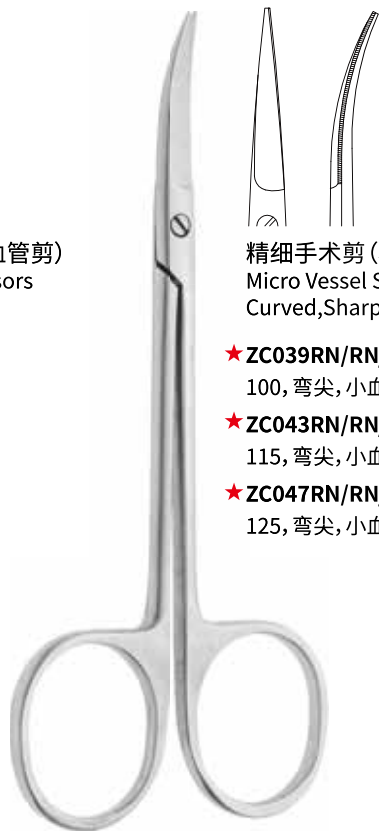

① 精细手术剪 (小血管剪)  
 Micro Vessel Scissors  
 Curved, Sharp

- ★ ZC039RN/RNj  
100, 弯尖, 小血管
- ★ ZC043RN/RNj  
115, 弯尖, 小血管
- ★ ZC047RN/RNj  
125, 弯尖, 小血管



① 精细手术剪 (小血管剪)  
 Micro Vessel Scissors  
 Curved, Blunt

- ★ ZC040RN/RNj  
100, 弯圆, 小血管
- ★ ZC044RN/RNj  
115, 弯圆, 小血管
- ★ ZC048RN/RNj  
125, 弯圆, 小血管

编码后缀注释: RN—亚光无镀层 RNj—镀金圈 RB—刷光无镀层 Note:RN-sand blasted matt surface RNj:gold coated ring RB:brushed matt surface



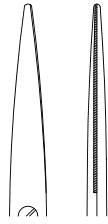
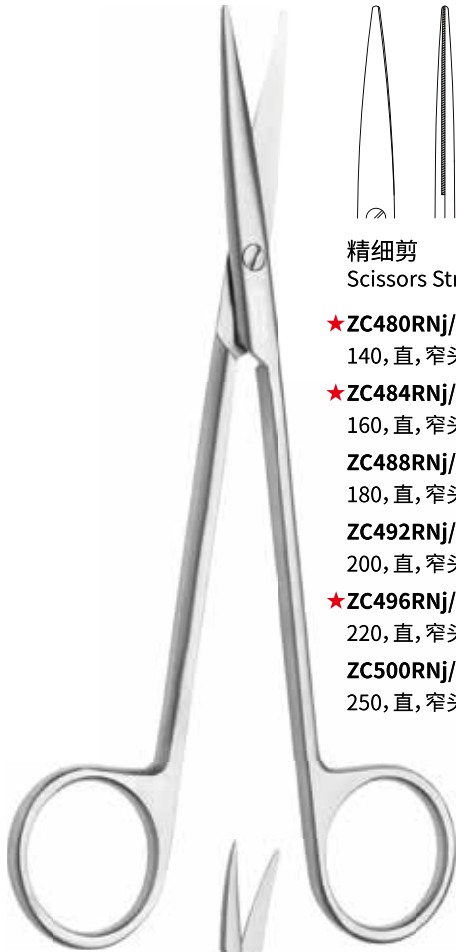

精细剪  
 Scissors Straight

- ★ **ZC480RNj/RB**  
140, 直, 窄头1.5
- ★ **ZC484RNj/RB**  
160, 直, 窄头1.5
- ZC488RNj/RB**  
180, 直, 窄头1.5
- ZC492RNj/RB**  
200, 直, 窄头1.5
- ★ **ZC496RNj/RB**  
220, 直, 窄头1.5
- ZC500RNj/RB**  
250, 直, 窄头1.5

- ZC482RNj/RB**  
140, 直, 宽头2
- ZC486RNj/RB**  
160, 直, 宽头3
- ZC490RNj/RB**  
180, 直, 宽头3
- ★ **ZC494RNj/RB**  
200, 直, 宽头3
- ZC498RNj/RB**  
220, 直, 宽头3
- ZC502RNj/RB**  
250, 直, 宽头3

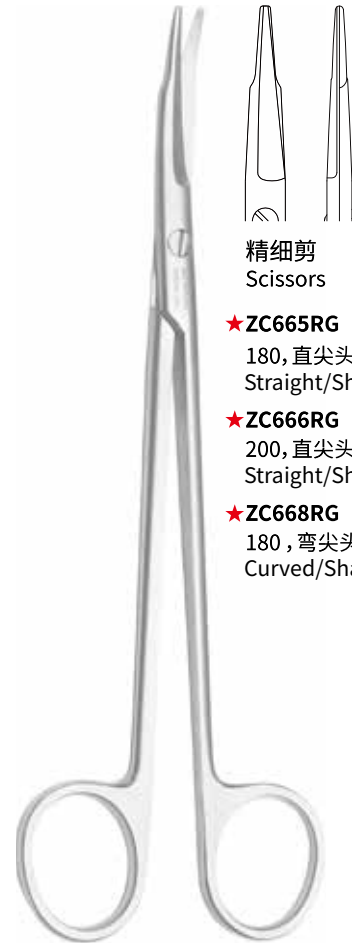

精细剪  
 Scissors

- ★ **ZC665RG**  
180, 直尖头, 头宽2  
Straight/Sharp Tip 2mm
- ★ **ZC666RG**  
200, 直尖头, 头宽2  
Straight/Sharp Tip 2mm
- ★ **ZC668RG**  
180, 弯尖头, 宽1.4  
Curved/Sharp Tip 1.4mm

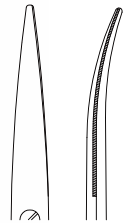

精细剪  
 Scissors Curved

- ★ **ZC481RNj/RB**  
140, 弯, 窄头1.5
- ★ **ZC485RNj/RB**  
160, 弯, 窄头1.5
- ★ **ZC489RNj/RB**  
180, 弯, 窄头1.5
- ★ **ZC493RNj/RB**  
200, 弯, 窄头1.5

- ★ **ZC497RNj/RB**  
220, 弯, 窄头1.5
- ★ **ZC501RNj/RB**  
250, 弯, 窄头1.5
- ZC483RNj/RB**  
140, 弯, 宽头2
- ★ **ZC487RNj/RB**  
160, 弯, 宽头3

- ★ **ZC491RNj/RB**  
180, 弯, 宽头3
- ★ **ZC495RNj/RB**  
200, 弯, 宽头3
- ★ **ZC499RNj/RB**  
220, 弯, 宽头3
- ★ **ZC503RNj/RB**  
250, 弯, 宽头3



基础器械  
 Standard Instruments

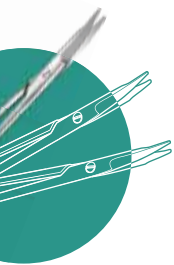

基础器械  
 Standard Instruments

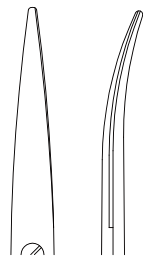

精细剪  
 Scissors Curved

- ★ **ZC675RG**  
180, 弯头, 宽3 Tip 3
- ★ **ZC676RG**  
200, 弯头, 宽3.5 Tip 3.5
- ★ **ZC678RG**  
250, 弯

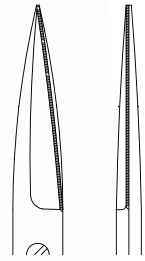
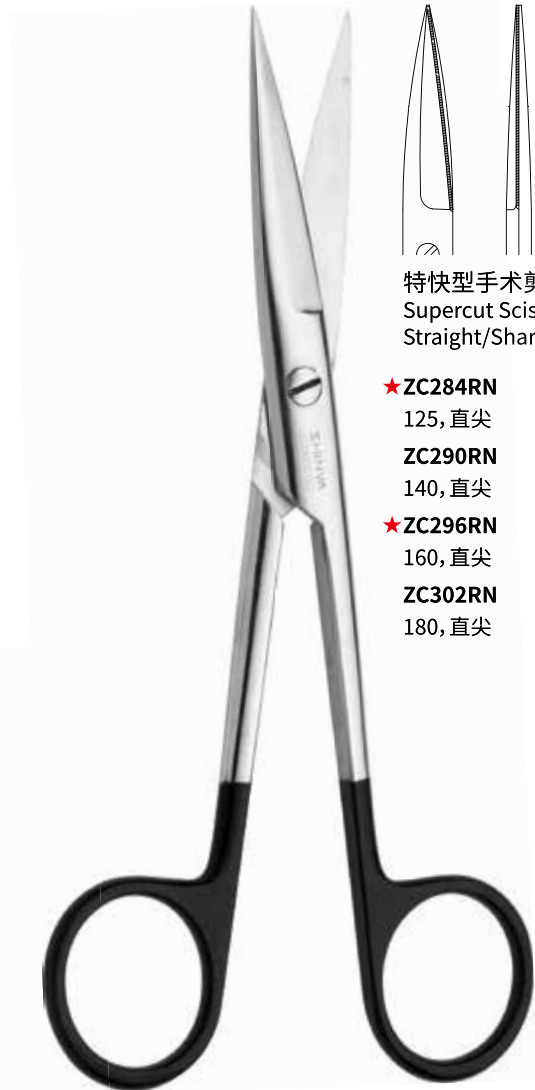

特快型手术剪  
 Supercut Scissors  
 Straight/Sharp

- ★ **ZC284RN**  
125, 直尖
- ZC290RN**  
140, 直尖
- ★ **ZC296RN**  
160, 直尖
- ZC302RN**  
180, 直尖

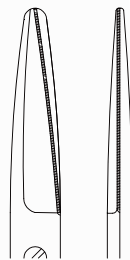

特快型手术剪  
 Supercut Scissors  
 Straight/Blunt

- ZC282RN**  
125, 直圆
- ★ **ZC288RN**  
140, 直圆
- ★ **ZC294RN**  
160, 直圆
- ★ **ZC300RN**  
180, 直圆



特快型手术剪  
Supercut Scissors  
Straight/Sharp/Blunt

- ZC283RN**  
125, 直尖圆
- ZC289RN**  
140, 直尖圆
- ZC295RN**  
160, 直尖圆
- ZC301RN**  
180, 直尖圆



特快型手术剪  
Supercut Scissors  
Curved/Sharp

- ZC287RN**  
125, 弯尖
- ZC293RN**  
140, 弯尖
- ★ **ZC299RN**  
160, 弯尖
- ★ **ZC307RN**  
180, 弯尖



特快型手术剪  
Supercut Scissors  
Curved/Blunt

- ZC285RN**  
125, 弯圆
- ZC291RN**  
140, 弯圆
- ★ **ZC297RN**  
160, 弯圆
- ★ **ZC305RN**  
180, 弯圆



基础器械  
Standard Instruments

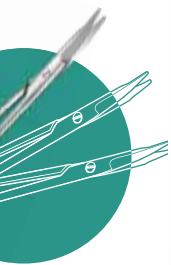

基础器械  
 Standard Instruments



特快型手术剪  
 Supercut Scissors  
 Curved/Sharp/Blunt

- ZC286RN**  
125, 弯尖圆
- ZC292RN**  
140, 弯尖圆
- ZC298RN**  
160, 弯尖圆
- ZC306RN**  
180, 弯尖圆



特快型组织剪  
 Supercut Scissors Straight

- ★ **ZC529RN**  
140, 直
- ZC531RN**  
160, 直
- ★ **ZC533RN**  
180, 直
- ★ **ZC535RN**  
200, 直
- ★ **ZC537RN**  
220, 直
- ZC539RN**  
250, 直

特快型组织剪  
 Supercut Scissors Curved

- ★ **ZC530RN**  
140, 弯
- ★ **ZC532RN**  
160, 弯
- ★ **ZC534RN**  
180, 弯
- ZC536RN**  
200, 弯
- ZC538RN**  
220, 弯
- ZC540RN**  
250, 弯

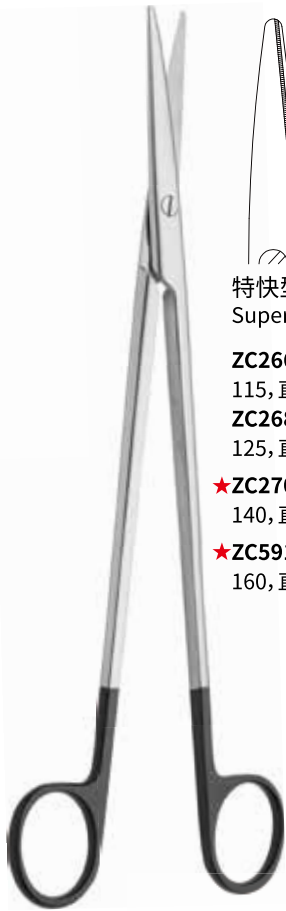

特快型综合组织剪  
Supercut Scissors Straight

- |                  |                  |
|------------------|------------------|
| <b>ZC266RN</b>   | <b>ZC593RN</b>   |
| 115, 直           | 180, 直           |
| <b>ZC268RN</b>   | <b>ZC595RN</b>   |
| 125, 直           | 200, 直           |
| ★ <b>ZC270RN</b> | ★ <b>ZC597RN</b> |
| 140, 直           | 220, 直           |
| ★ <b>ZC591RN</b> | <b>ZC599RN</b>   |
| 160, 直           | 250, 直           |

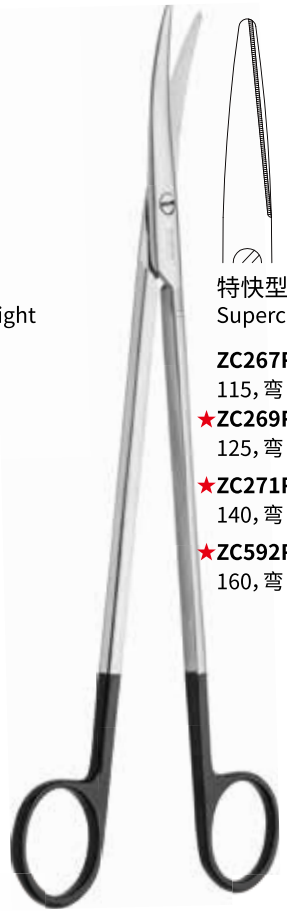

特快型综合组织剪  
Supercut Scissors Curved

- |                  |                  |
|------------------|------------------|
| <b>ZC267RN</b>   | ★ <b>ZC594RN</b> |
| 115, 弯           | 180, 弯           |
| ★ <b>ZC269RN</b> | ★ <b>ZC596RN</b> |
| 125, 弯           | 200, 弯           |
| ★ <b>ZC271RN</b> | ★ <b>ZC598RN</b> |
| 140, 弯           | 220, 弯           |
| ★ <b>ZC592RN</b> | ★ <b>ZC600RN</b> |
| 160, 弯           | 250, 弯           |



特快型综合组织剪  
Supercut Scissors Straight/Blunt

- |                |                |
|----------------|----------------|
| <b>ZC242RN</b> | <b>ZC250RN</b> |
| 115, 直扁平       | 180, 直扁平       |
| <b>ZC244RN</b> | <b>ZC252RN</b> |
| 125, 直扁平       | 200, 直扁平       |
| <b>ZC246RN</b> | <b>ZC254RN</b> |
| 140, 直扁平       | 220, 直扁平       |
| <b>ZC248RN</b> |                |
| 160, 直扁平       |                |



特快型综合组织剪  
Supercut Scissors Curved/Blunt

- |                |                |
|----------------|----------------|
| <b>ZC243RN</b> | <b>ZC251RN</b> |
| 115, 弯扁平       | 180, 弯扁平       |
| <b>ZC245RN</b> | <b>ZC253RN</b> |
| 125, 弯扁平       | 200, 弯扁平       |
| <b>ZC247RN</b> | <b>ZC255RN</b> |
| 140, 弯扁平       | 220, 弯扁平       |
| <b>ZC249RN</b> |                |
| 160, 弯扁平       |                |



特快型综合组织剪  
Supercut Scissors Straight

- |                |
|----------------|
| <b>ZC256RN</b> |
| 180, 直中棱       |
| <b>ZC258RN</b> |
| 200, 直中棱       |

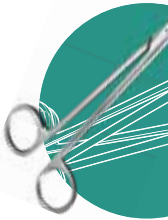

基础器械  
Standard Instruments

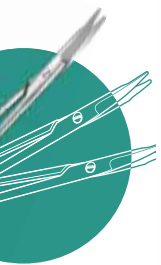

基础器械  
 Standard Instruments



特快型综合组织剪  
 Supercut Scissors Curved

- ZC257RN**  
180, 弯中棱
- ZC259RN**  
200, 弯中棱

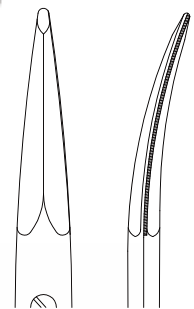

特快型综合组织剪  
 Supercut Scissors Straight

- ZC260RN**  
180, 直, 扒杆
- ZC262RN**  
200, 直, 扒杆

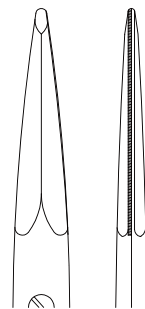

特快型综合组织剪  
 Supercut Scissors Curved

- ZC261RN**  
180, 弯, 扒杆
- ZC263RN**  
200, 弯, 扒杆

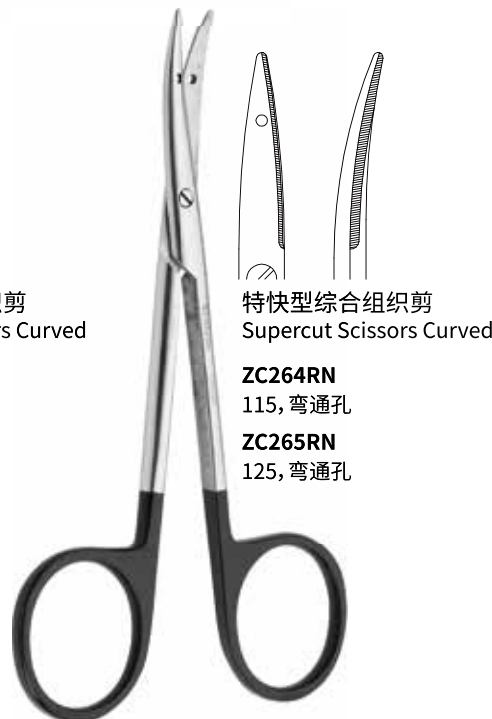
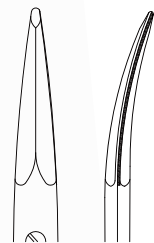

特快型综合组织剪  
 Supercut Scissors Curved

- ZC264RN**  
115, 弯通孔
- ZC265RN**  
125, 弯通孔

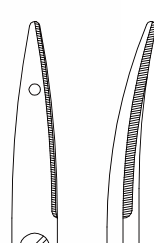



特快型综合组织剪  
Supercut scissors curved

- ZC272RN**  
110, 弯, 弯杆
- ZC273RN**  
140, 弯, 弯杆
- ZC274RN**  
160, 弯, 弯杆



特快型综合组织剪  
Supercut Scissors  
Straight/Angled  
Shank

- ZC275RN**  
140, 直, 角弯杆
- ZC276RN**  
160, 直, 角弯杆

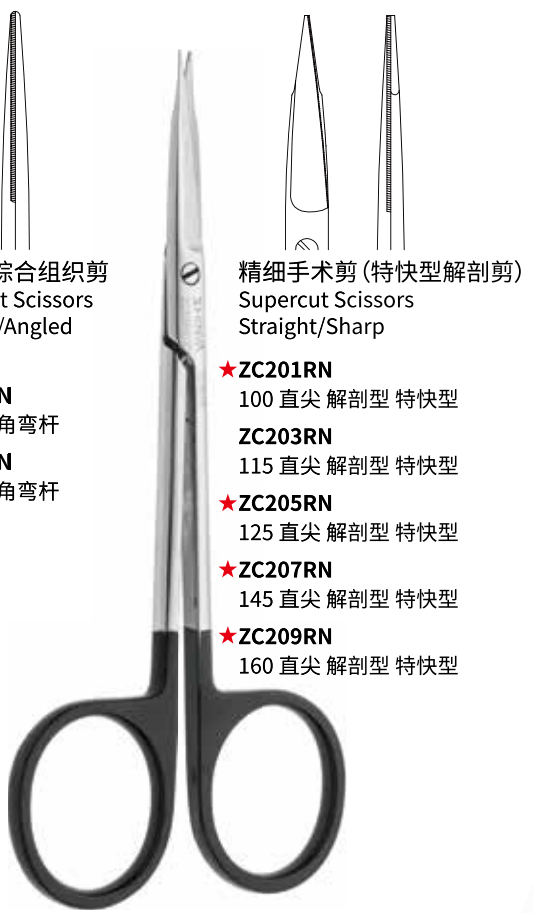

精细手术剪 (特快型解剖剪)  
Supercut Scissors  
Straight/Sharp

- ★ **ZC201RN**  
100 直尖 解剖型 特快型
- ZC203RN**  
115 直尖 解剖型 特快型
- ★ **ZC205RN**  
125 直尖 解剖型 特快型
- ★ **ZC207RN**  
145 直尖 解剖型 特快型
- ★ **ZC209RN**  
160 直尖 解剖型 特快型

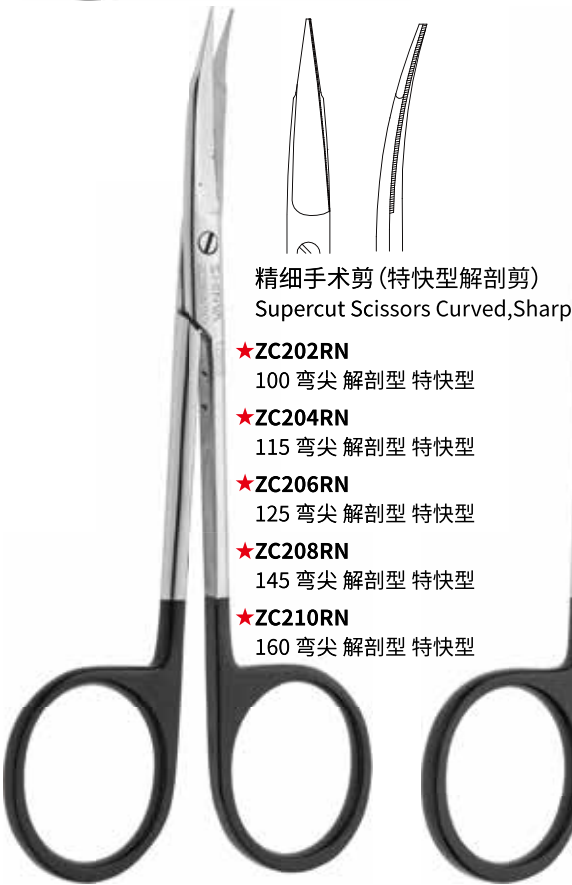

精细手术剪 (特快型解剖剪)  
Supercut Scissors Curved, Sharp

- ★ **ZC202RN**  
100 弯尖 解剖型 特快型
- ★ **ZC204RN**  
115 弯尖 解剖型 特快型
- ★ **ZC206RN**  
125 弯尖 解剖型 特快型
- ★ **ZC208RN**  
145 弯尖 解剖型 特快型
- ★ **ZC210RN**  
160 弯尖 解剖型 特快型



精细手术剪 (特快型解剖剪)  
Supercut Scissors Straight, Blunt

- ★ **ZC211RN**  
115 直圆 解剖型 特快型
- ★ **ZC213RN**  
125 直圆 解剖型 特快型
- ★ **ZC215RN**  
145 直圆 解剖型 特快型
- ★ **ZC217RN**  
160 直圆 解剖型 特快型

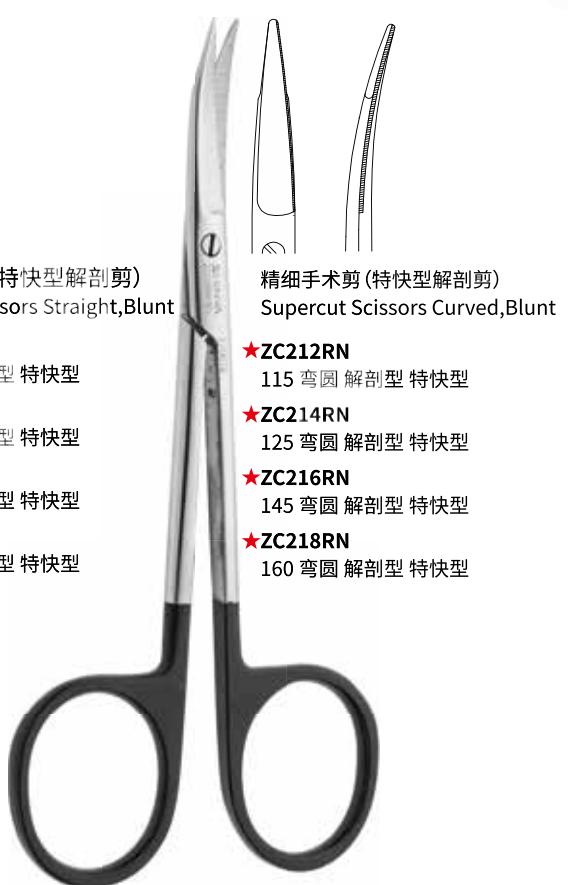

精细手术剪 (特快型解剖剪)  
Supercut Scissors Curved, Blunt

- ★ **ZC212RN**  
115 弯圆 解剖型 特快型
- ★ **ZC214RN**  
125 弯圆 解剖型 特快型
- ★ **ZC216RN**  
145 弯圆 解剖型 特快型
- ★ **ZC218RN**  
160 弯圆 解剖型 特快型



基础器械  
Standard Instruments

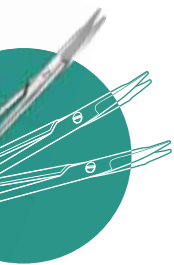

基础器械  
Standard Instruments

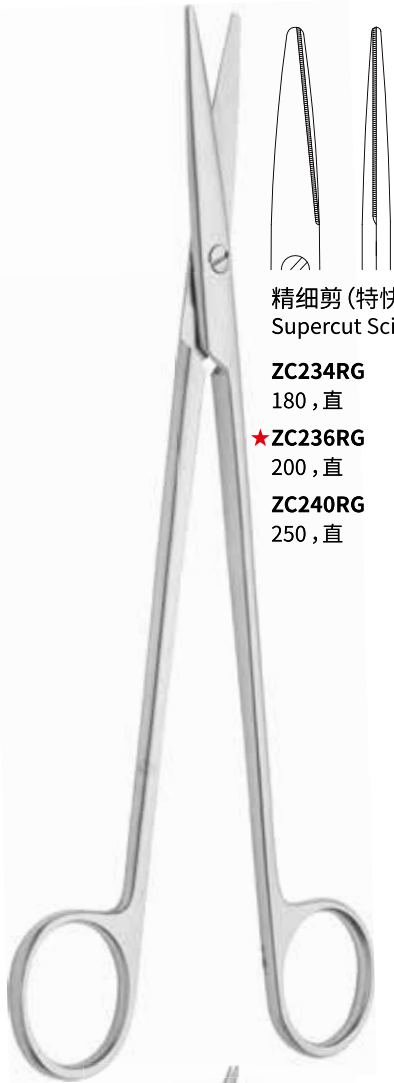

精细剪 (特快型解剖剪)  
Supercut Scissors Straight

- ZC234RG**  
180, 直
- ★ **ZC236RG**  
200, 直
- ZC240RG**  
250, 直

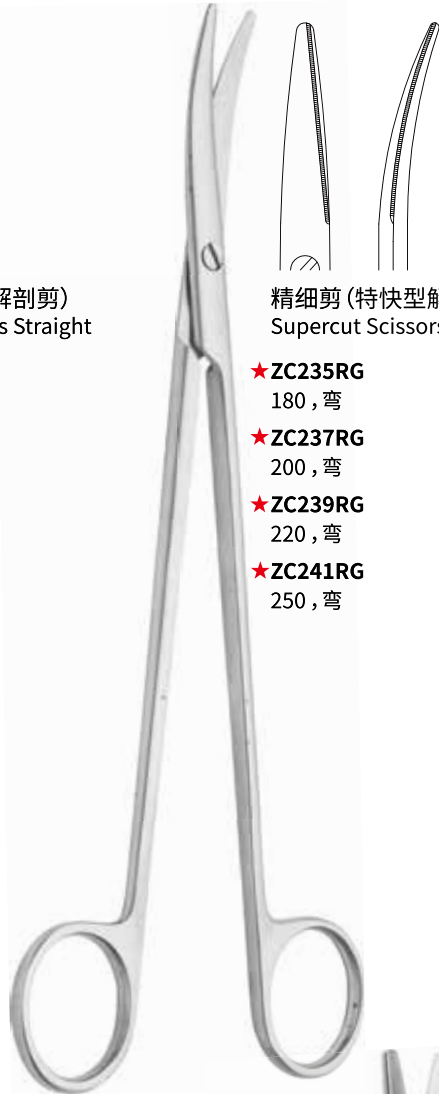

精细剪 (特快型解剖剪)  
Supercut Scissors Curved

- ★ **ZC235RG**  
180, 弯
- ★ **ZC237RG**  
200, 弯
- ★ **ZC239RG**  
220, 弯
- ★ **ZC241RG**  
250, 弯



精细手术剪 (特快型小血管剪)  
TC Supercut Scissors Straight, Sharp

- ★ **ZC219RN**  
100 直尖 小血管 特快型
- ★ **ZC221RN**  
115 直尖 小血管 特快型
- ★ **ZC223RN**  
125 直尖 小血管 特快型
- ★ **ZC225RN**  
140 直尖 小血管 特快型



精细手术剪 (特快型小血管剪)  
Supercut Scissors Curved, Sharp

- |                                    |                                    |
|------------------------------------|------------------------------------|
| ★ <b>ZC220RN</b><br>100 弯尖 小血管 特快型 | ★ <b>ZC224RN</b><br>125 弯尖 小血管 特快型 |
| ★ <b>ZC222RN</b><br>115 弯尖 小血管 特快型 | ★ <b>ZC226RN</b><br>140 弯尖 小血管 特快型 |



组织剪  
TC Dissecting Scissors Straight

- ZC875RB**  
140, 直, 镶片
- ZC877RB**  
160, 直, 镶片
- ZC879RB**  
180, 直, 镶片
- ZC881RB**  
200, 直, 镶片
- ZC883RB**  
220, 直, 镶片





组织剪  
TC Dissecting Scissors Curved

- ZC876RB**  
140, 弯, 镶片
- ZC878RB**  
160, 弯, 镶片
- ZC880RB**  
180, 弯, 镶片
- ZC882RB**  
200, 弯, 镶片
- ZC884RB**  
220, 弯, 镶片

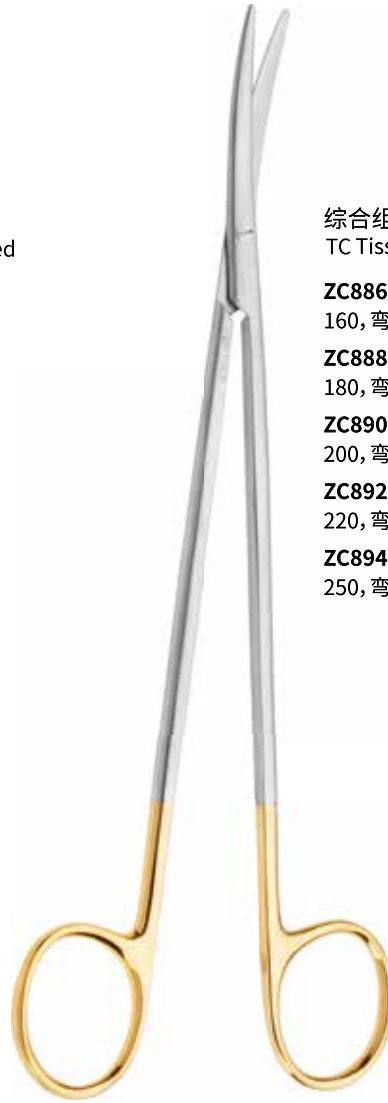

综合组织剪  
TC Tissue Scissors Curved

- ZC886RB**  
160, 弯, 镶片
- ZC888RB**  
180, 弯, 镶片
- ZC890RB**  
200, 弯, 镶片
- ZC892RB**  
220, 弯, 镶片
- ZC894RB**  
250, 弯, 镶片



综合组织剪  
TC Tissue Scissors Straight

- ZC885RB**  
160, 直, 镶片
- ZC887RB**  
180, 直, 镶片
- ZC889RB**  
200, 直, 镶片
- ZC891RB**  
220, 直, 镶片
- ZC893RB**  
250, 直, 镶片



精细剪  
TC Scissors Straight

- ZC895RB**  
180, 直, 镶片
- ZC897RB**  
200, 直, 镶片
- ZC899RB**  
220, 直, 镶片
- ZC901RB**  
250, 直, 镶片



基础器械  
Standard Instruments

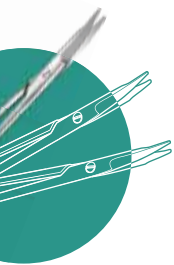

基础器械  
Standard Instruments



精细剪  
TC Scissors Straight  
Curved

- ZC896RB**  
180, 弯, 镶片
- ZC898RB**  
200, 弯, 镶片
- ZC900RB**  
220, 弯, 镶片
- ZC902RB**  
250, 弯, 镶片



精细剪  
TC Scissors Curved

- ZC903RB**  
180, 弯型, 镶片
- ZC904RB**  
200, 弯型, 镶片
- ZC905RB**  
230, 弯型, 镶片



眼用剪  
TC Ophthalmic  
Scissors Straight

- ZC906RB**  
90, 直, 镶片
- ZC908RB**  
110, 直, 镶片



眼用剪  
TC Ophthalmic  
Scissors Curved

- ZC907RB**  
90, 弯, 镶片
- ZC909RB**  
110, 弯, 镶片



精细手术剪  
TC Surgical Scissors Straight

- ZC910RB**  
140, 直, 小血管, 镶片



精细手术剪  
TC Surgical Scissors Curved

- ZC911RB**  
140, 弯, 小血管, 镶片



解剖剪  
 TC Delicate Scissors Straight  
**ZC912RB**  
 125, 直, 解剖型, 镶片



解剖剪  
 TC Delicate Scissors Curved  
**ZC913RB**  
 125, 弯, 解剖型, 镶片

止血钳  
 Haemostatic Forceps  
 Straight, Pean

- ★ **ZH104RN**  
100, 直微蚊
- ★ **ZH108MN**  
125, 直蚊, 精细
- ★ **ZH110R/MB/RB**  
125, 直蚊
- ★ **ZH144R/MB/RB**  
140, 直全
- ★ **ZH442R/MB/RB**  
160, 直全
- ★ **ZH444R/MB/RB**  
180, 直全
- ★ **ZH446R/MB/RB**  
200, 直全
- ★ **ZH448R/RB**  
220, 直全
- ★ **ZH450R/RB**  
240, 直全
- ★ **ZH452R/RB**  
260, 直全

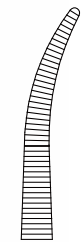
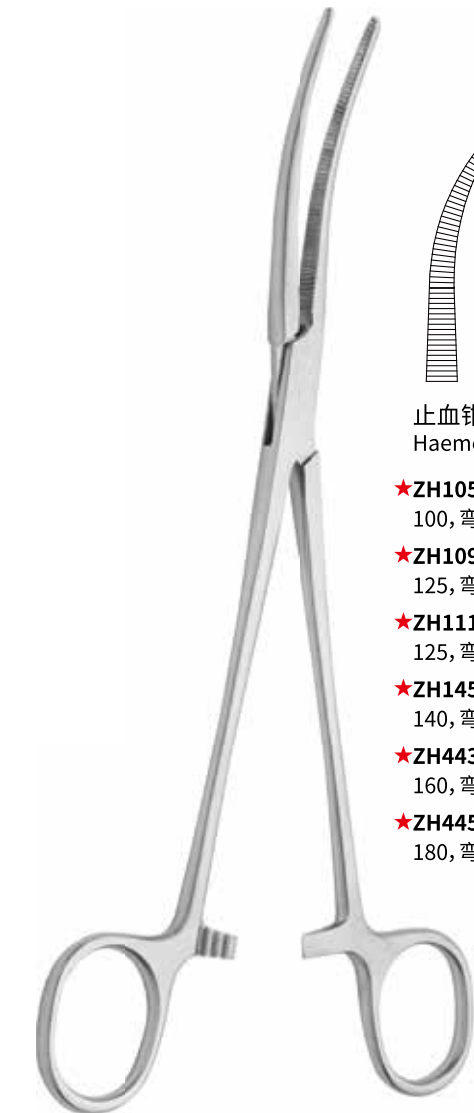

止血钳  
 Haemostatic Forceps Curved, Pean

- |                                  |                                  |
|----------------------------------|----------------------------------|
| ★ <b>ZH105RN</b><br>100, 弯微蚊     | ★ <b>ZH447R/MB/RB</b><br>200, 弯全 |
| ★ <b>ZH109MN</b><br>125, 弯蚊, 精细  | ★ <b>ZH449R/RB</b><br>220, 弯全    |
| ★ <b>ZH111R/MB/RB</b><br>125, 弯蚊 | ★ <b>ZH451R/RB</b><br>240, 弯全    |
| ★ <b>ZH145R/MB/RB</b><br>140, 弯全 | ★ <b>ZH453R/RB</b><br>260, 弯全    |
| ★ <b>ZH443R/MB/RB</b><br>160, 弯全 |                                  |
| ★ <b>ZH445R/MB/RB</b><br>180, 弯全 |                                  |

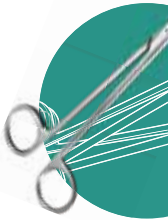

基础器械  
 Standard Instruments

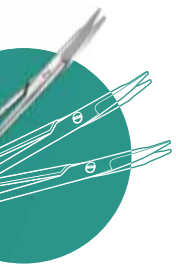

基础器械  
Standard Instruments



止血钳  
Kelly Haemostatic Forceps Curved

- ZH131R/RN**  
140, 弯半齿
- ZH165R/RN**  
160, 弯半齿
- ZH201R/RN**  
180, 弯半齿



止血钳  
Kelly Haemostatic Forceps Straight

- ZH130R/RN**  
140, 直半齿
- ZH164R/RN**  
160, 直半齿
- ZH200R/RN**  
180, 直半齿

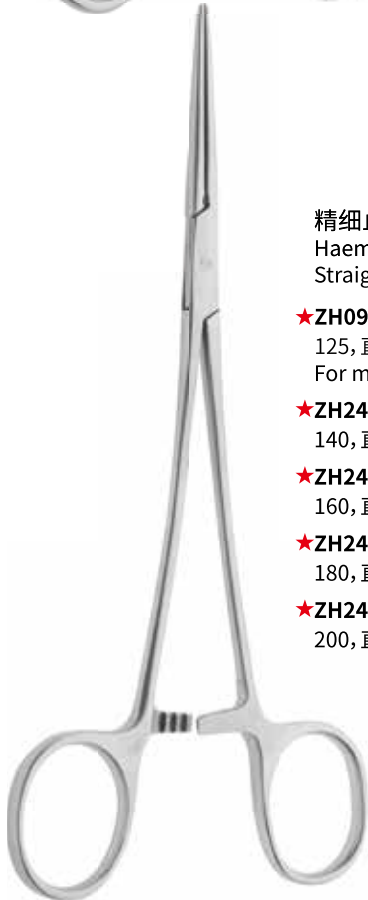

精细止血钳  
Haemostatic Forceps  
Straight, Pean Slim pattern

- ★ **ZH096RB**  
125, 直全, 微血管  
For micro vessel
- ★ **ZH240RN**  
140, 直全
- ★ **ZH242RN**  
160, 直全
- ★ **ZH244RN**  
180, 直全
- ★ **ZH246RN**  
200, 直全

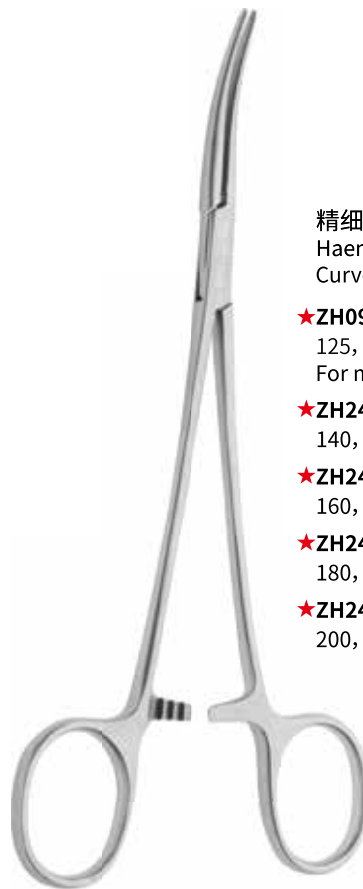

精细止血钳  
Haemostatic Forceps  
Curved, Pean Slim pattern

- ★ **ZH097RB**  
125, 弯全, 微血管  
For micro vessel
- ★ **ZH241RN**  
140, 弯全
- ★ **ZH243RN**  
160, 弯全
- ★ **ZH245RN**  
180, 弯全
- ★ **ZH247RN**  
200, 弯全

编码后缀注释: R—电镀 RN—亚光无镀层 RB—刷光无镀层 MB—高新高精系列  
Note: R-chrome plated RN-sand blasted surface RB-brushed matt surface MB-17-4, open box lock

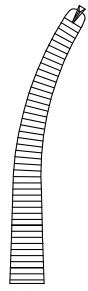

止血钳  
Haemostatic Forceps  
Curved, Kocher

- ★ZH103RB  
125, 蚊式, 弯有钩
- ★ZH155R/RB  
140, 弯有钩
- ★ZH643R/RB  
160, 弯有钩
- ★ZH645R/RB  
180, 弯有钩
- ★ZH647R/RB  
200, 弯有钩
- ★ZH649R/RB  
220, 弯有钩
- ★ZH651R/RB  
240, 弯有钩
- ★ZH653RB  
260, 弯有钩



止血钳  
Haemostatic Forceps  
Straight, Kocher

- ★ZH102RB  
125, 蚊式 直有钩
- ★ZH154R/RB  
140, 直有钩
- ★ZH642R/RB  
160, 直有钩
- ★ZH644R/RB  
180, 直有钩
- ★ZH646R/RB  
200, 直有钩
- ★ZH648R/RB  
220, 直有钩
- ★ZH650R/RB  
240, 直有钩
- ★ZH652RB  
260, 直有钩



止血钳  
Haemostatic Forceps  
Curved, without Hook

- ZH900R  
210, 三弯, 全齿, 无钩



组织钳  
Tissue Forceps

- ★ZE012R/MB/RB  
140
- ★ZE016R/MB/RB  
160
- ★ZE017R/MB/RB  
180
- ★ZE018R/MB/RB  
200



基础器械  
Standard Instruments

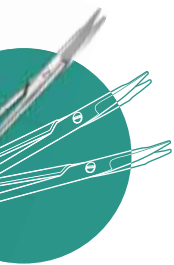

基础器械  
 Standard Instruments

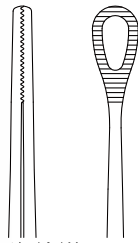

海绵钳  
 Sponge Forceps Straight, Serrated

- ★ZE128R/MB/RB  
250×8, 直有齿
- ★ZE118R/MB/RB  
250×10, 直有齿
- ★ZE122R/MB/RB  
250×12, 直有齿

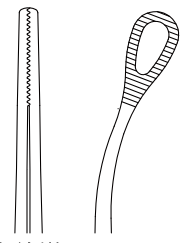

海绵钳  
 Sponge Forceps curved, Serrated

- ★ZE117R/MB/RB  
250×8, 弯有齿
- ★ZE127R/MB/RB  
250×10, 弯有齿
- ★ZE123R/MB/RB  
250×12, 弯有齿

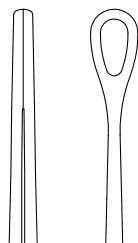

海绵钳  
 Sponge Forceps Straight, Smooth

- ★ZE130R/MB/RB  
250×8, 直无齿
- ★ZE124R/MB/RB  
250×10, 直无齿
- ★ZE120R/MB/RB  
250×12, 直无齿

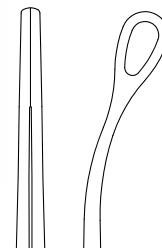

海绵钳  
 Sponge Forceps curved, Smooth

- ★ZE119R/MB/RB  
250×8, 弯无齿
- ★ZE125R/MB/RB  
250×10, 弯无齿
- ★ZE121R/MB/RB  
250×12, 弯无齿

编码后缀注释: R—电镀 RB—刷光无镀层 MB—高新高精系列  
 Note: R-chrome plated RB-brushed matt surface MB-17-4, open box lock

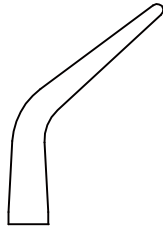

帕巾钳  
Towel Clamp

- ★ZE431R/MB/RB  
90
- ★ZE432R/MB/RB  
110
- ★ZE433R/MB/RB  
140
- ★ZE440R/MB/RB  
160



帕巾钳  
Towel Clamp

- ★ZE445RB  
130, 球头
- ★ZE446RB  
150, 球头



帕巾钳  
Towel Clamp

**ZE448RB**  
130, 埃式



帕巾钳  
Towel Clamp

- ★ZE443RB  
100, 平头
- ★ZE444RB  
130, 平头

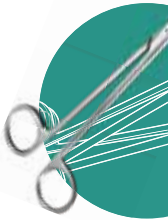

基础器械  
Standard Instruments

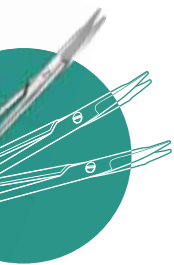

基础器械  
 Standard Instruments

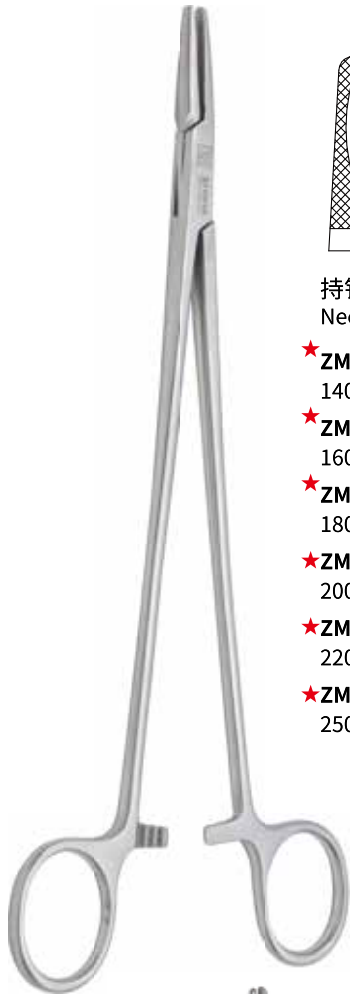

持针钳  
 Needle Holder Thick Needle

- ★ **ZM234R/RB**  
140, 粗针
- ★ **ZM246R/RB**  
160, 粗针
- ★ **ZM236R/RB**  
180, 粗针
- ★ **ZM237R/RB**  
200, 粗针
- ★ **ZM238R/RB**  
220, 粗针
- ★ **ZM239R/RB**  
250, 粗针

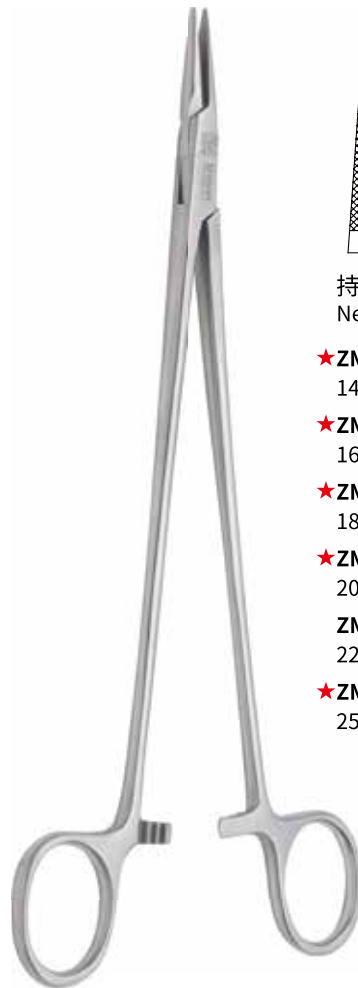

持针钳  
 Needle Holder Thin Needle

- ★ **ZM240R/RB**  
140, 细针
- ★ **ZM247R/RB**  
160, 细针
- ★ **ZM242R/RB**  
180, 细针
- ★ **ZM243R/RB**  
200, 细针
- ZM244R/RB**  
220, 细针
- ★ **ZM245R/RB**  
250, 细针

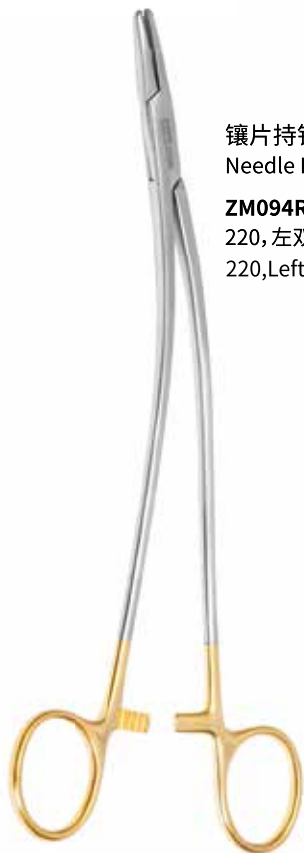

镶片持针钳  
 Needle Holder

**ZM094R**  
 220, 左双弯, 粗针, 镶片0.5  
 220, Left Curved, TC 0.5



镶片持针钳  
 Needle Holder

**ZM095R**  
 220, 右双弯, 粗针, 镶片0.5  
 220, Right Curved, TC 0.5





镶片持针钳  
TC Needle Holder  
Straight Thick Needle

- ZM015R**  
140, 直, 粗针0.5
- ZM032R**  
160, 直, 粗针0.5
- ZM066R**  
180, 直, 粗针0.5
- ZM077R**  
200, 直, 粗针0.5
- ZM079R**  
220, 直, 粗针0.5
- ZM097R**  
250, 直, 粗针0.5
- ZM122R**  
260, 直, 粗针0.5
- ZM123R**  
280, 直, 粗针0.5

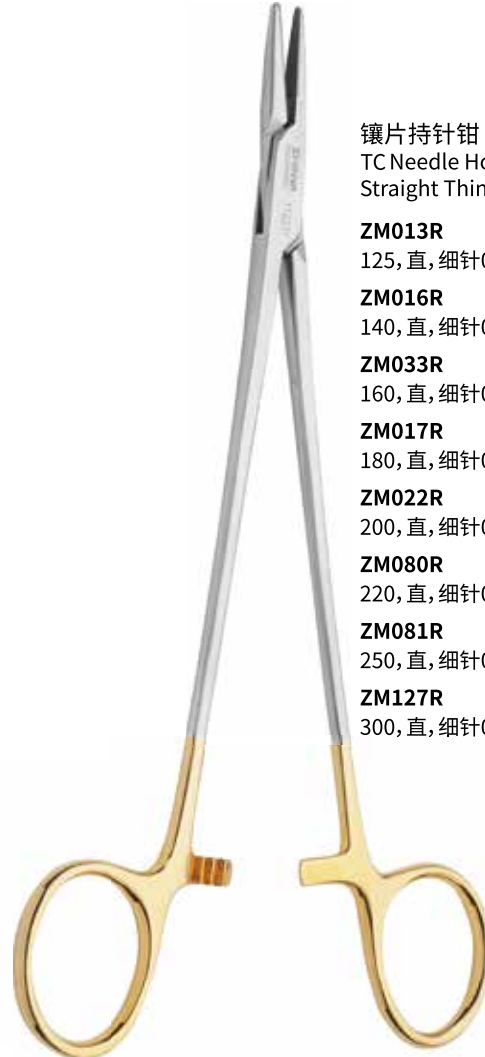

镶片持针钳  
TC Needle Holder  
Straight Thin Needle

- ZM013R**  
125, 直, 细针0.3
- ZM016R**  
140, 直, 细针0.3
- ZM033R**  
160, 直, 细针0.3
- ZM017R**  
180, 直, 细针0.3
- ZM022R**  
200, 直, 细针0.3
- ZM080R**  
220, 直, 细针0.3
- ZM081R**  
250, 直, 细针0.3
- ZM127R**  
300, 直, 细针0.3



镶片持针钳  
TC Needle Holder Straight, Ryder

- ZM068R**  
125, 直窄, 无损伤针0.2
- ZM071R**  
140, 直窄, 无损伤针0.2
- ZM072R**  
160, 直窄, 无损伤针0.2
- ZM018R**  
180, 直窄, 无损伤针0.2
- ZM073R**  
200, 直窄, 无损伤针0.2
- ZM074R**  
220, 直窄, 无损伤针0.2

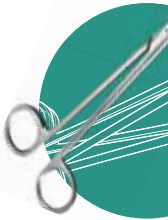

基础器械  
Standard Instruments

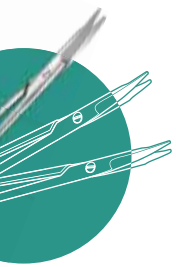

基础器械  
Standard Instruments



镶片持针钳  
TC Needle Holder Straight  
Narrow, Thin Needle

- ZM130R**  
140, 直窄, 细针 0.3
- ZM131R**  
180, 直窄, 细针 0.3
- ZM132R**  
200, 直窄, 细针 0.3
- ZM133R**  
260, 直窄, 细针 0.3



镶片持针钳  
TC Needle Holder, Thick Needle

- ZM141R**  
280, 双弯, 粗针 0.5



镶片持针钳  
TC Needle Holder Straight  
Thick Needle

- ZM124R**  
200 直, 粗针 0.5, 双弯杆
- ZM125R**  
240 直, 粗针 0.5, 双弯杆
- ZM126R**  
300 直, 粗针 0.5, 双弯杆



镶片持针钳  
TC Needle Holder, Thick Needle

- ZM096R**  
230, 双弯, 粗针 0.5



镶片持针钳  
TC Needle Holder Straight,  
Thin Needle

**ZM128R**  
180, 直, 细针0.3, 八字杆  
**ZM129R**  
260, 直, 细针0.3, 八字杆

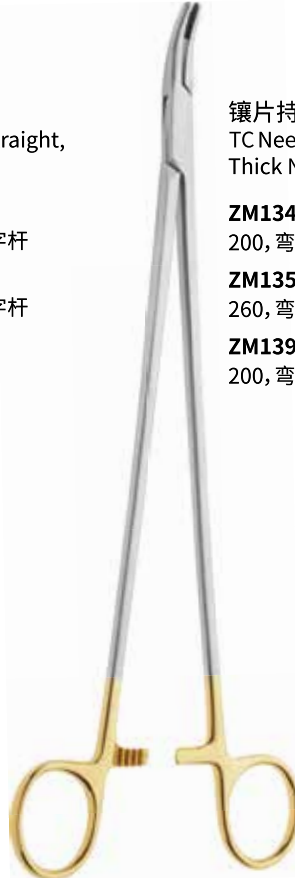

镶片持针钳  
TC Needle Holder Curved  
Thick Needle

**ZM134R**  
200, 弯, 粗针0.5  
**ZM135R**  
260, 弯, 粗针0.5  
**ZM139R**  
200, 弯, 细针0.3



镶片持针钳  
TC Needle Holder Curved  
Thick Needle

**ZM136R**  
210, 弯, 粗针0.5, 侧弯杆  
**ZM137R**  
230, 弯, 粗针0.5, 侧弯杆



镶片持针钳  
TC Needle Holder Curved  
Thick Needle

**ZM138R**  
220, 弯, 粗针0.5, 弯杆



镶片持针钳  
TC Needle Holder Angled  
Curved, Thick Needle

**ZM140R**  
260, 角弯, 粗针 0.5



基础器械  
Standard Instruments

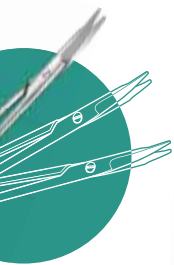
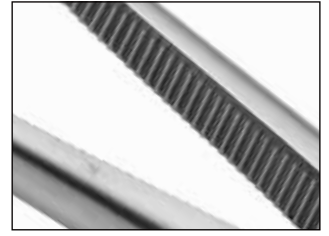

基础器械  
 Standard Instruments

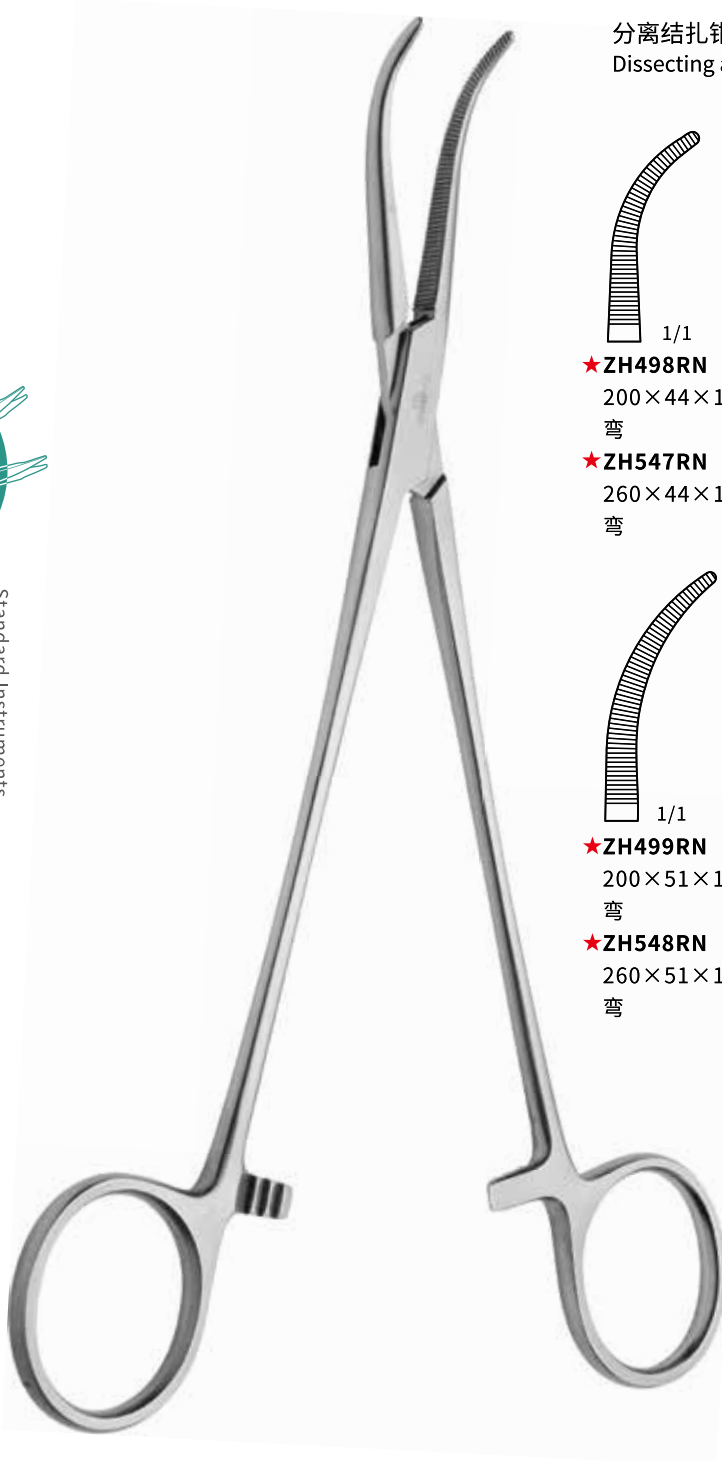

分离结扎钳  
 Dissecting and Ligature Forceps Curved

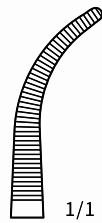

1/1

★ZH498RN

200×44×14

弯

★ZH547RN

260×44×14

弯

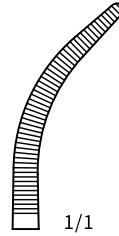

1/1

ZH470RN

135×45×17

弯

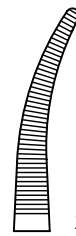

1/1

★ZH562RN

280×47×9

弯

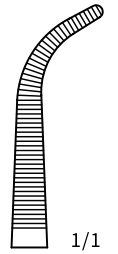

1/1

★ZH549RN

260×50×14

弯

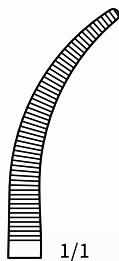

1/1

★ZH499RN

200×51×17

弯

★ZH548RN

260×51×17

弯

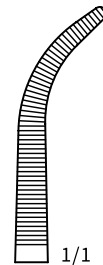

1/1

★ZH496RN

200×52×14

弯

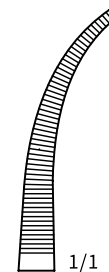

1/1

★ZH305RN

240×53×13

弯

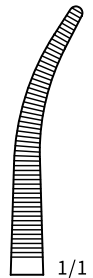

1/1

★ZH497RN

200×54×11

弯

编码后缀注释:RN—亚光无镀层 Note: RN-sand blasted matt surface

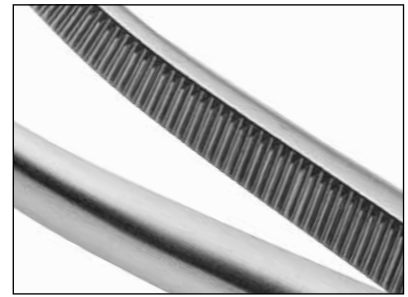

分离结扎钳  
 Dissecting and Ligature Forceps Curved

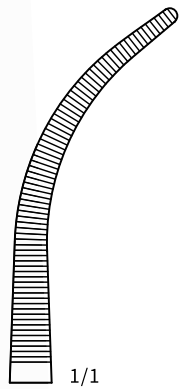
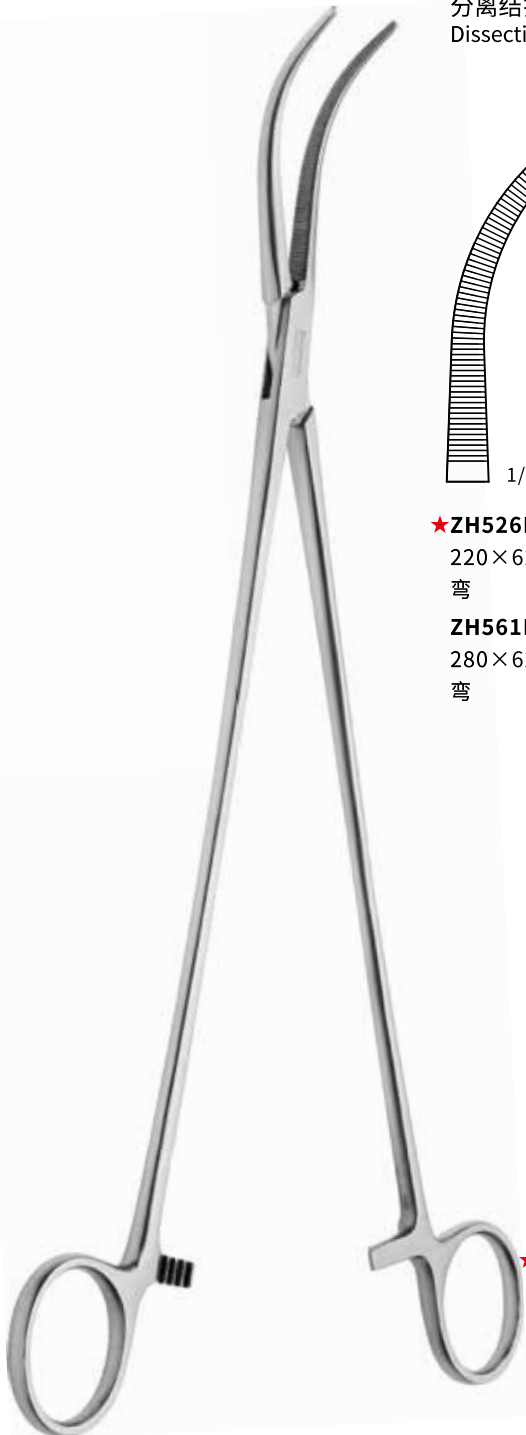

★ZH526RN  
 220×62×22  
 弯  
 ZH561RN  
 280×62×22  
 弯

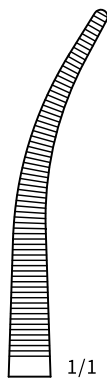

★ZH525RN  
 220×61×13  
 弯  
 ★ZH560RN  
 280×61×13  
 弯

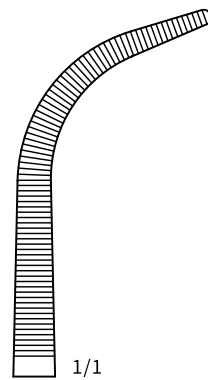

★ZH528RN  
 240×60×26  
 弯

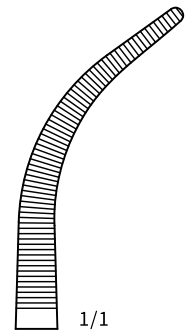

★ZH515RN  
 220×55×22  
 弯  
 ★ZH410RN  
 270×55×22  
 弯  
 ZH555RN  
 280×55×22  
 弯

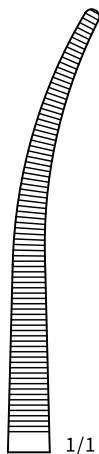

★ZH531RN  
 240×71×12  
 弯

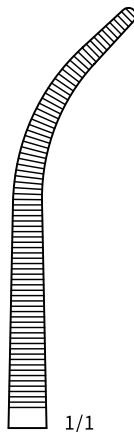

★ZH530RN  
 240×68×17  
 弯

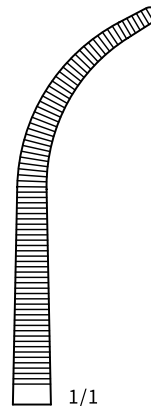

★ZH529RN  
 240×65×19  
 弯

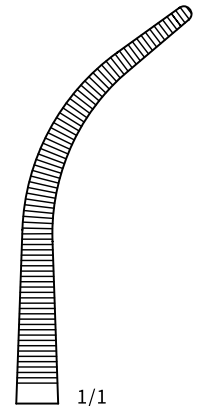

★ZH516RN  
 220×65×23  
 弯  
 ZH556RN  
 280×65×23  
 弯

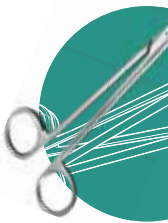

基础器械  
 Standard Instruments

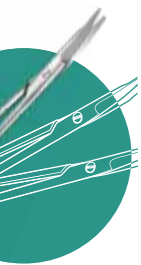
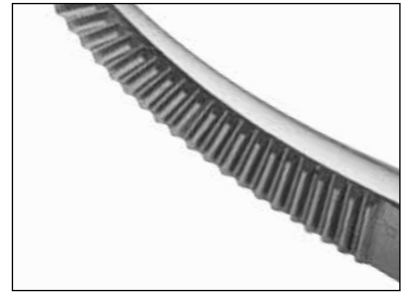

基础器械  
 Standard Instruments

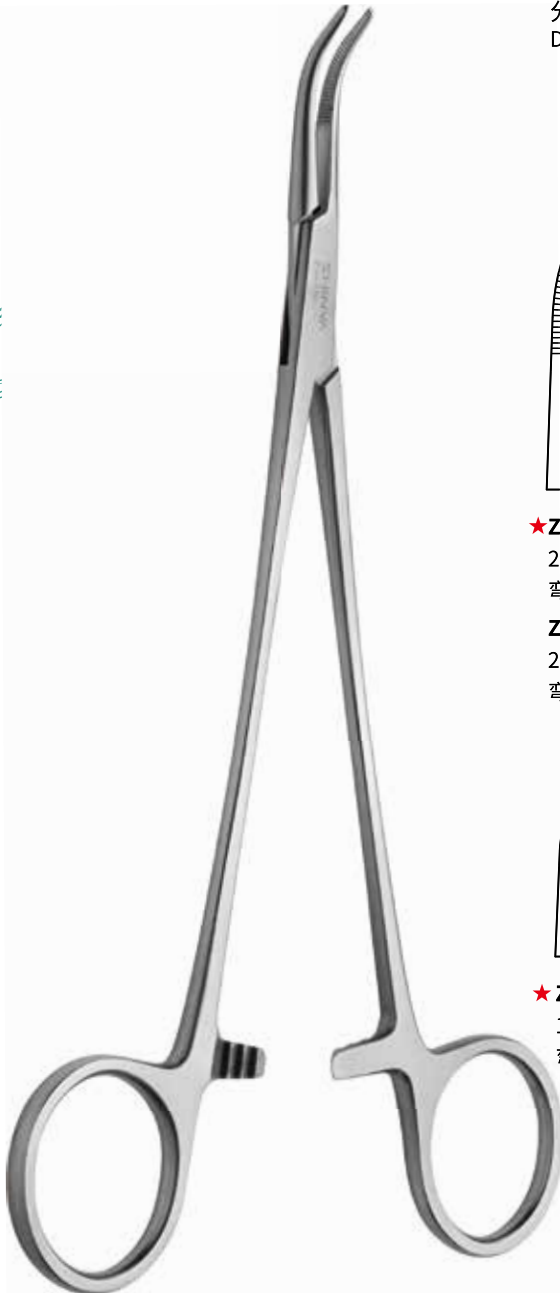

分离结扎钳  
 Dissecting and Ligature Forceps Curved, Half Teeth

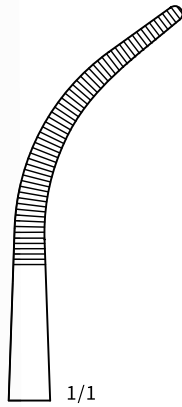

★ZH518RN  
 220×65×23  
 弯, 半齿  
 ZH559RN  
 280×65×23  
 弯, 半齿

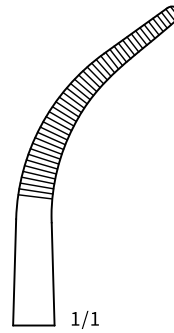

★ZH517RN  
 220×55×22  
 弯, 半齿  
 ZH558RN  
 280×55×22  
 弯, 半齿

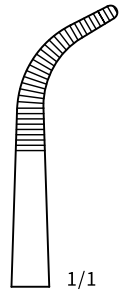

★ZH500RN  
 200×50×14  
 弯, 半齿  
 ★ZH545RN  
 260×50×14  
 弯, 半齿

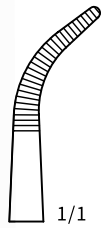

★ZH477RN  
 180×38×12  
 弯, 半齿

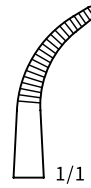

ZH471RN  
 140×33×11  
 弯, 半齿

编码后缀注释: RN—亚光无镀层

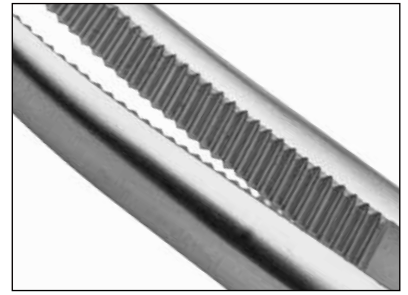

分离结扎钳  
Dissecting and Ligature Forceps Curved, Half Teeth

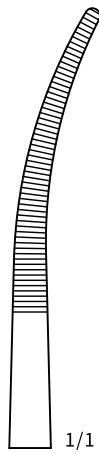

★ZH543RN  
240×71×12  
弯, 半齿

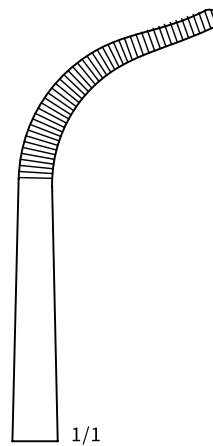

ZH327RN  
240×70×26  
弯, 半齿

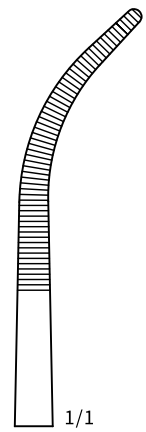

★ZH542RN  
240×68×17  
弯, 半齿

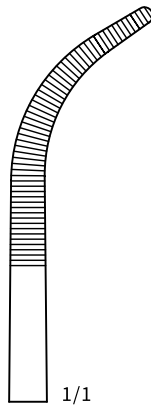

★ZH541RN  
240×65×19  
弯, 半齿

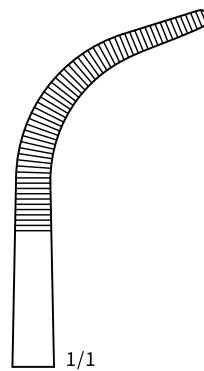

ZH540RN  
240×60×26  
弯, 半齿

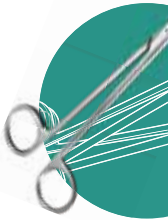

基础器械  
Standard Instruments

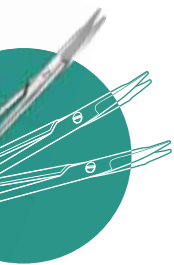

基础器械  
 Standard Instruments



分离结扎钳  
 Dissecting and Ligature Forceps, Curved, Curved Handle

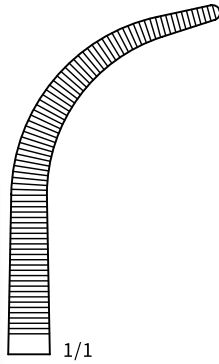

★ZH523RN  
 220×59×28  
 弯, 弯柄

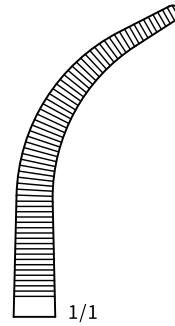

ZH522RN  
 220×54×22  
 弯, 弯柄

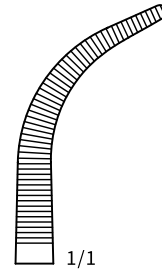

★ZH504RN  
 200×47×20  
 弯, 弯柄

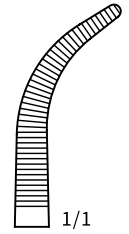

★ZH481RN  
 180×41×14  
 弯, 弯柄

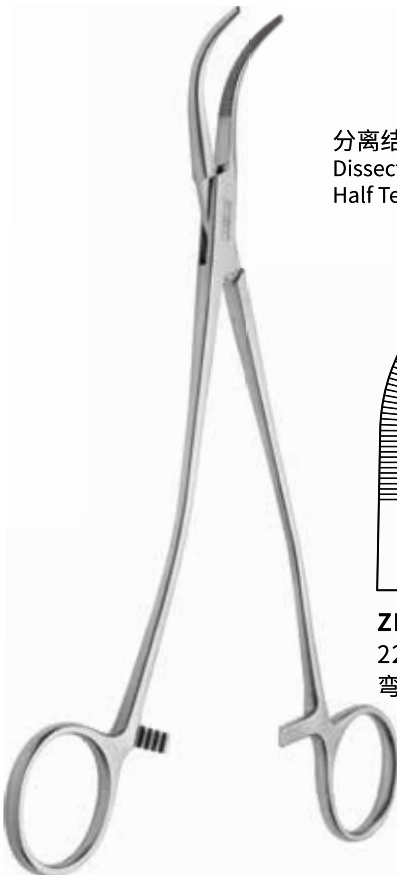

分离结扎钳  
 Dissecting and Ligature Forceps, Curved, Curved Handle,  
 Half Teeth

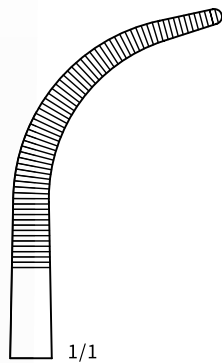
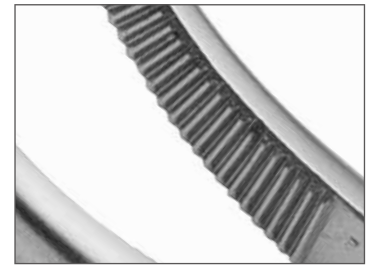

ZH519RN  
 220×59×28  
 弯, 弯柄, 半齿

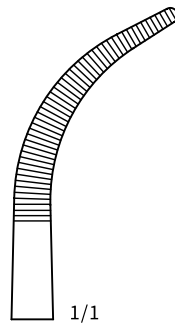

ZH527RN  
 220×54×22  
 弯, 弯柄, 半齿

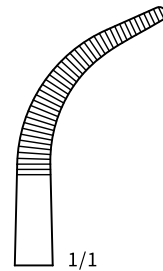

ZH495RN  
 200×47×20  
 弯, 弯柄, 半齿

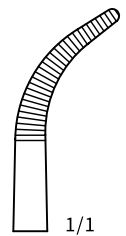

ZH494RN  
 180×41×14  
 弯, 弯柄, 半齿

编码后缀注释: RN—亚光无镀层



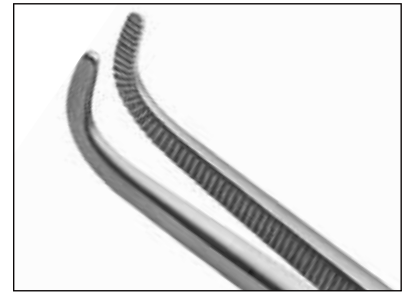

分离结扎钳  
 Dissecting and Ligature Forceps Angled Curved

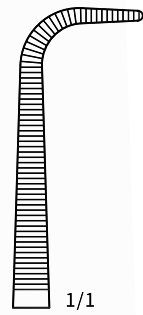
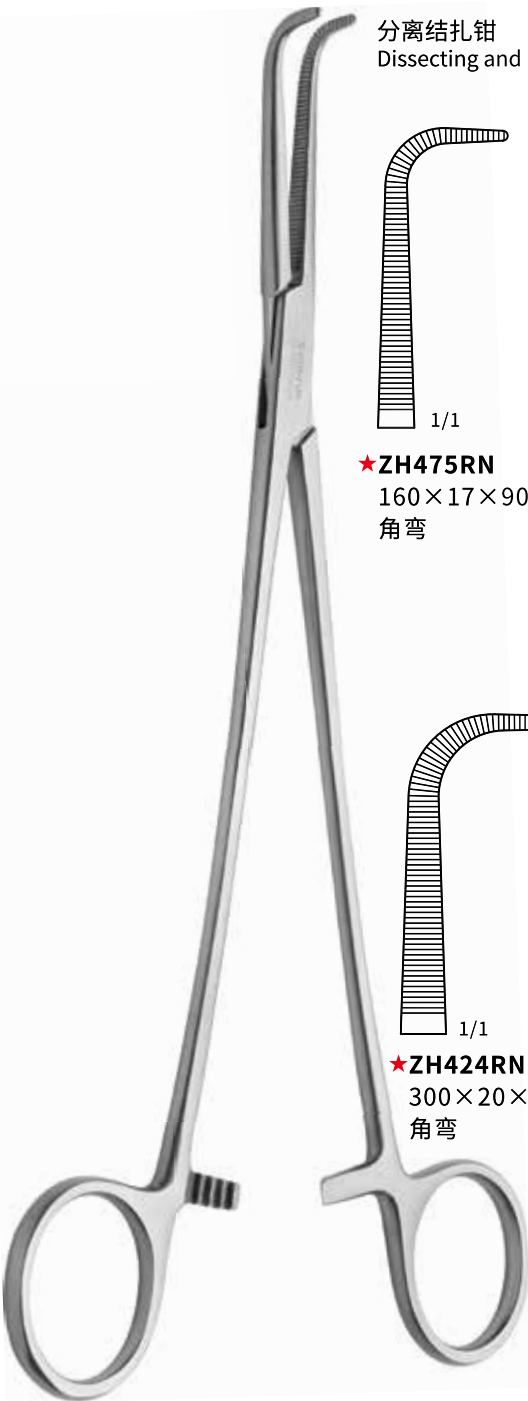

★ZH475RN  
 160×17×90°  
 角弯

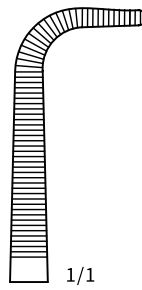

★ZH371RN  
 220×18×90°  
 角弯

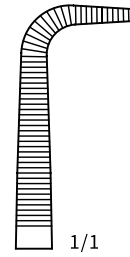

★ZH550RN  
 280×16×90°  
 角弯

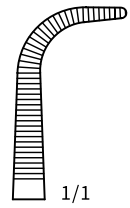

★ZH482RN  
 180×15×90°  
 角弯

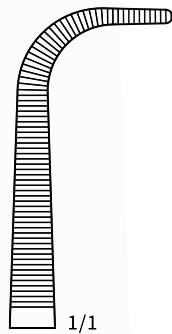

★ZH424RN  
 300×20×90°  
 角弯

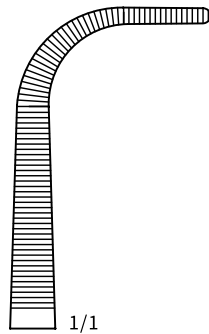

★ZH423RN  
 250×25×90°  
 角弯

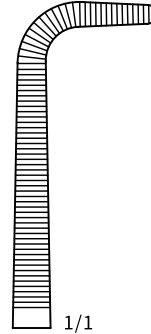

★ZH535RN  
 240×19×90°  
 角弯

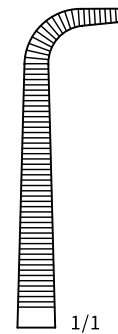

★ZH506RN  
 200×14×90°  
 角弯

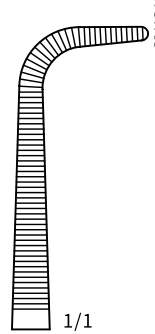

★ZH507RN  
 200×18×90°  
 角弯

★ZH524RN  
 220×14×90°  
 角弯

★ZH538RN  
 240×14×90°  
 角弯



基础器械  
 Standard Instruments

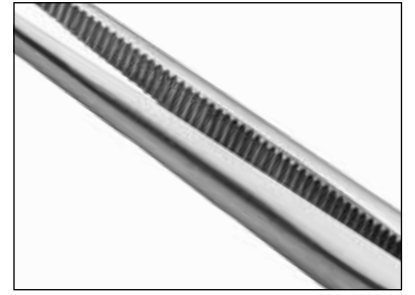

分离结扎钳  
 Dissecting and Ligature Forceps Angled Curved

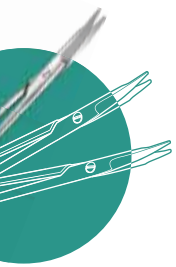

基础器械  
 Standard Instruments

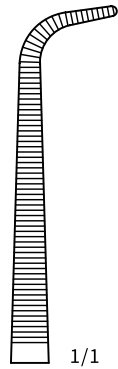
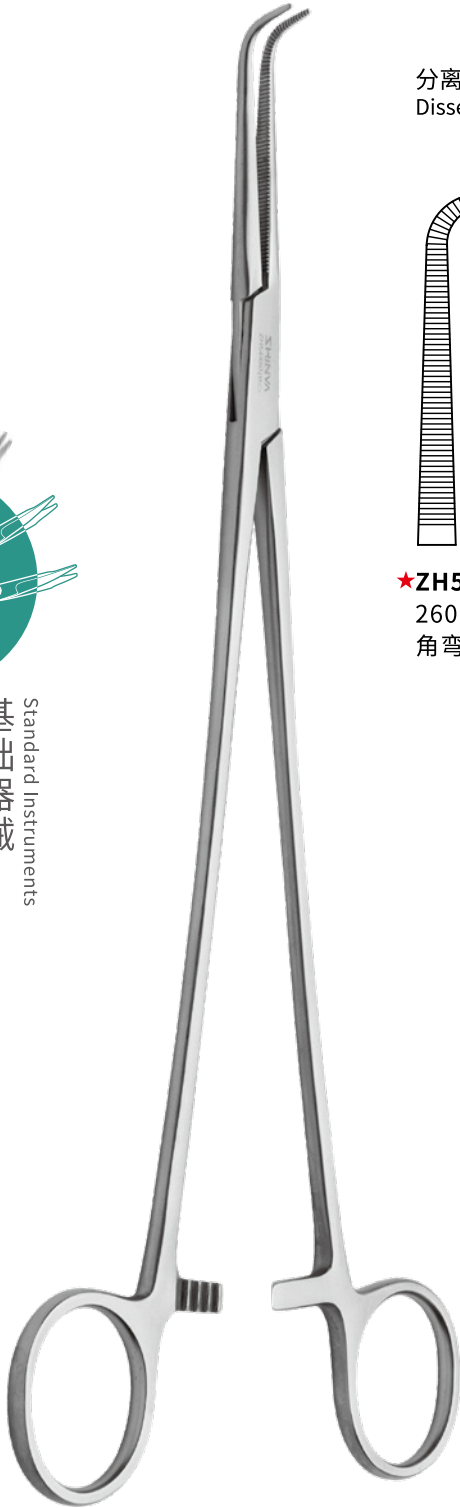

★ZH544RN  
 260×14×100°  
 角弯

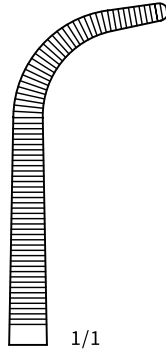

★ZH536RN  
 240×21×100°  
 角弯



★ZH505RN  
 200×17×100°  
 角弯

★ZH537RN  
 240×17×100°  
 角弯

1/1  
 ★ZH554RN  
 280×17×100°  
 角弯

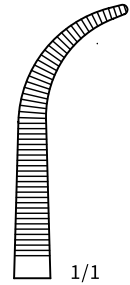

1/1  
 ★ZH553RN  
 280×15×105°  
 角弯

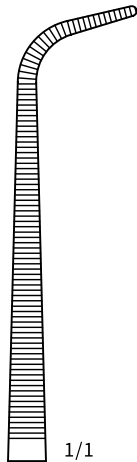

1/1  
 ★ZH552RN  
 280×16×100°  
 角弯

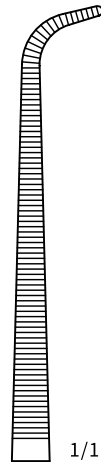

1/1  
 ★ZH551RN  
 280×12×100°  
 角弯

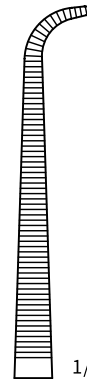

1/1  
 ★ZH546RN  
 260×10×100°  
 角弯

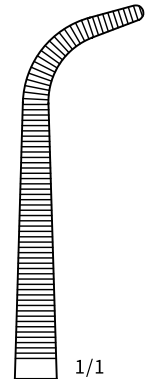

1/1  
 ★ZH501RN  
 200×17×105°  
 角弯

编码后缀注释: RN—亚光无镀层

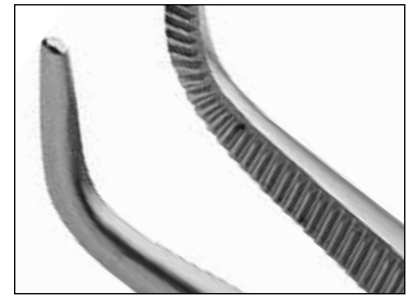

分离结扎钳  
 Dissecting and Ligature Forceps Angled Curved

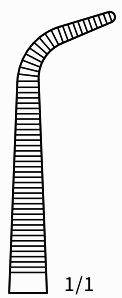
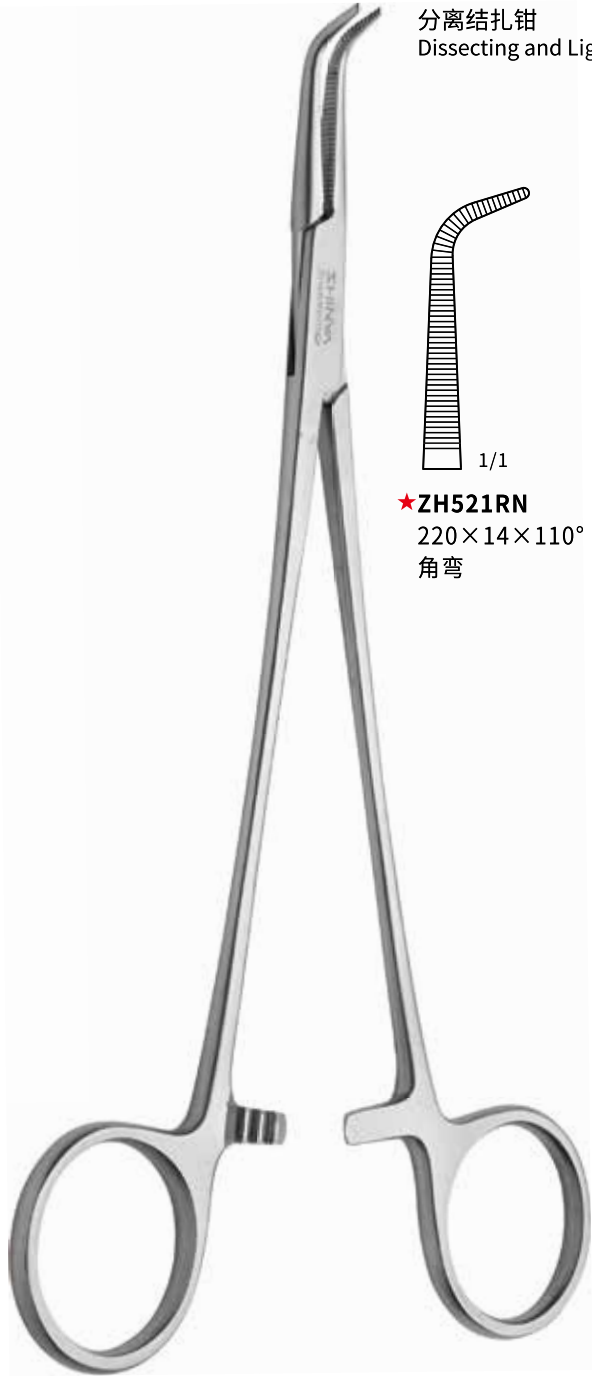

★ZH521RN  
 220×14×110°  
 角弯

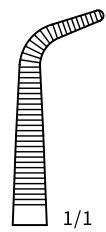

★ZH483RN  
 180×12×110°  
 角弯

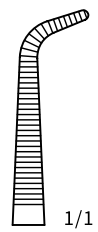

★ZH480RN  
 180×10×110°  
 角弯

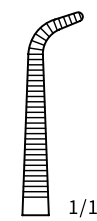

★ZH473RN  
 140×8×110°  
 角弯

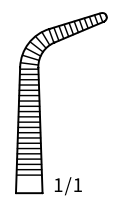

ZH472RN  
 140×12×110°  
 角弯

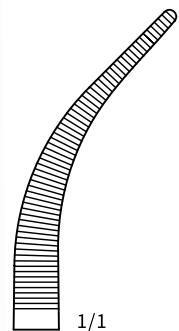

ZH425RN  
 300×20×135°  
 角弯

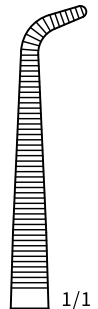

★ZH520RN  
 220×10×110°  
 角弯

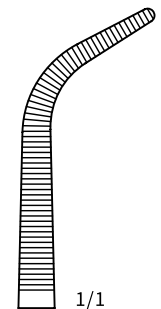

ZH476RN  
 160×18×120°  
 角弯

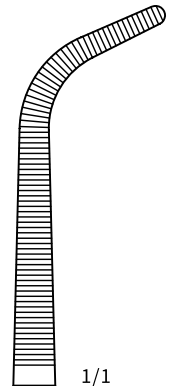

★ZH502RN  
 200×20×115°  
 角弯



基础器械  
 Standard Instruments

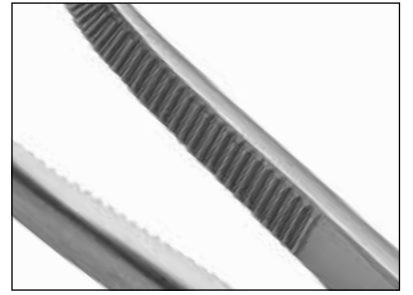

分离结扎钳  
 Dissecting and Ligature Forceps Angled Curved, Half Teeth

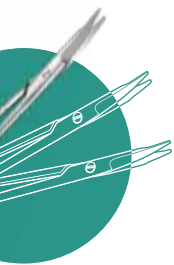

基础器械  
 Standard Instruments

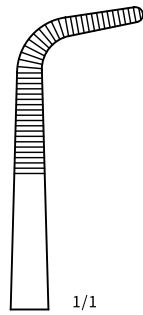

★ZH503RN  
 200×17×100°  
 角弯, 半齿

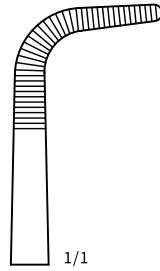

★ZH493RN  
 180×20×90°  
 角弯, 半齿

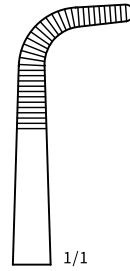

★ZH492RN  
 180×16×90°  
 角弯, 半齿

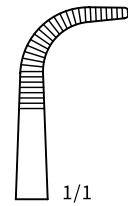

★ZH478RN  
 180×15×90°  
 角弯, 半齿

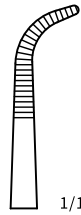

★ZH474RN  
 140×9×100°  
 角弯, 半齿

★ZH534RN  
 240×17×100°  
 角弯, 半齿

★ZH296RN  
 220×20×90°  
 角弯, 半齿

ZH557RN  
 280×17×100°  
 角弯, 半齿

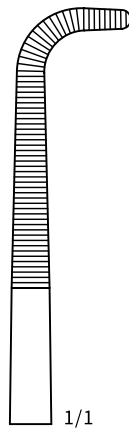

★ZH514RN  
 220×16×90°  
 角弯, 半齿

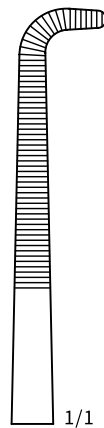

★ZH513RN  
 220×12×90°  
 角弯, 半齿

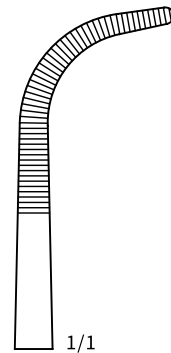

★ZH533RN  
 240×21×100°  
 角弯, 半齿

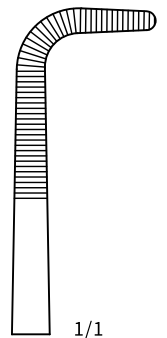

★ZH532RN  
 240×19×90°  
 角弯, 半齿

编码后缀注释: RN—亚光无镀层



分离结扎钳  
Dissecting and Ligature Forceps Angled Curved, Half Teeth

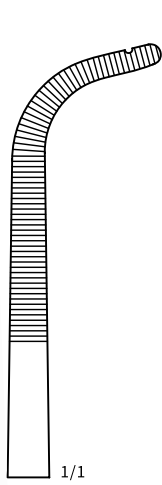

★ZH297RN  
220×20×103°  
带槽, 半齿

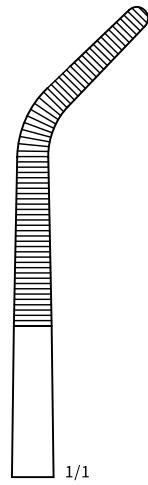

ZH512RN  
220×18×135°  
角弯, 半齿

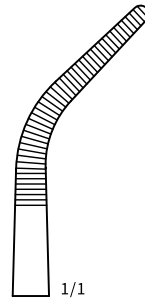

ZH491RN  
180×18×135°  
角弯, 半齿

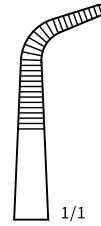

★ZH479RN  
180×12×110°  
角弯, 半齿

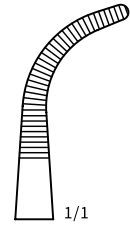

★ZH369RN  
200×14×110°  
角弯, 半齿

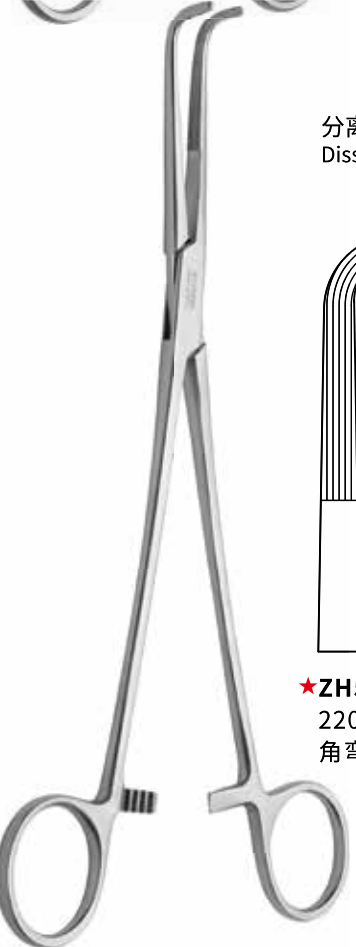
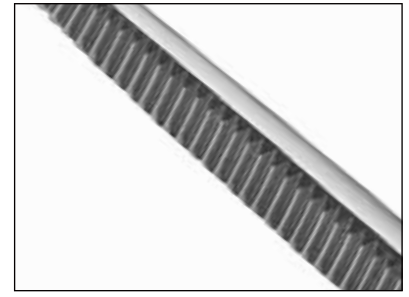

分离结扎钳  
Dissecting and Ligature Forceps Angled Curved

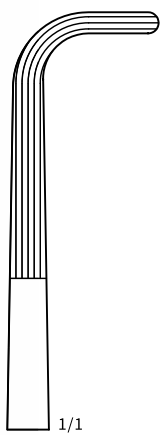

★ZH511RN  
220×20×90°  
角弯, 竖齿

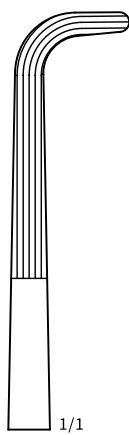

★ZH510RN  
220×16×90°  
角弯, 竖齿

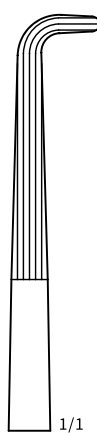

★ZH509RN  
220×12×90°  
角弯, 竖齿

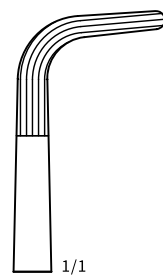

ZH486RN  
180×20×90°  
角弯, 竖齿

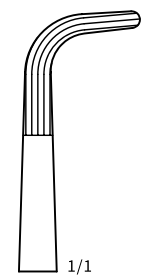

★ZH485RN  
180×16×90°  
角弯, 竖齿

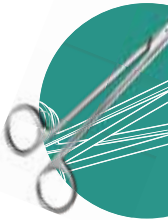
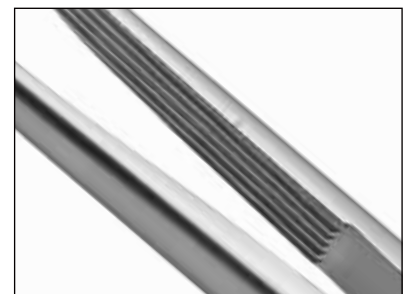

基础器械  
Standard Instruments

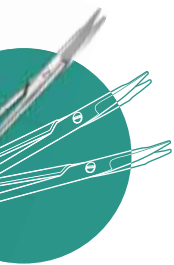

基础器械  
 Standard Instruments



分离结扎钳  
 Dissecting and Ligature Forceps Angled Curved

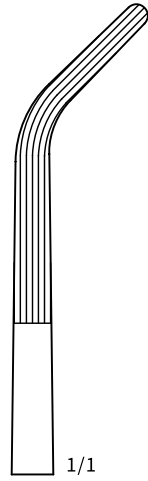

**ZH508RN**  
 220×18×135°  
 角弯, 竖齿

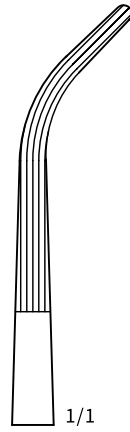

**ZH366RN**  
 220×15×135°  
 角弯, 竖齿

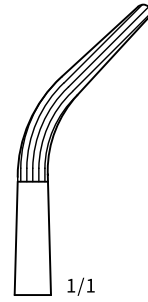

**ZH484RN**  
 180×18×135°  
 角弯, 竖齿

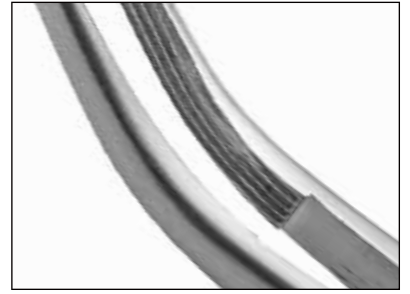

分离结扎钳  
 Dissecting and Ligature Forceps Angled Curved

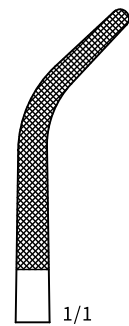

**ZH488RN**  
 180×15×135°  
 角弯, 网纹

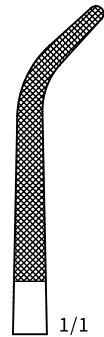

**ZH487RN**  
 180×12×135°  
 角弯, 网纹

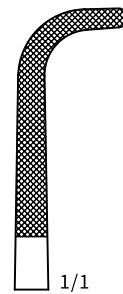

★**ZH490RN**  
 180×15×90°  
 角弯, 网纹

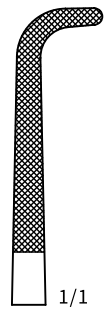

★**ZH489RN**  
 180×12×90°  
 角弯, 网纹

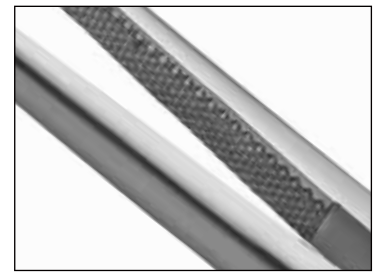

编码后缀注释: R—电镀 RN—亚光无镀层



器械钳 (持物钳)  
Holding Forceps  
Straight, Serrated  
★ZE150R  
250×12, 直有槽



器械钳 (持物钳)  
Holding Forceps  
★ZE152R  
320, 三叉  
★ZE155R  
250, 三叉



器械钳 (持物钳)  
Holding Forceps  
Curved, Serrated  
★ZE151R  
250×12, 弯有槽



子弹钳  
Sponge and  
Dressing Forceps  
★ZE055R  
230, 直, 麦粒  
straight  
★ZE059R  
270, 弯圆  
Curved, Blunt



基础器械  
Standard Instruments

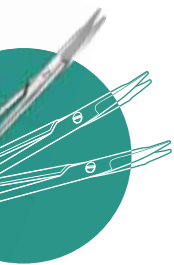

基础器械  
 Standard Instruments



组织镊  
 Tissue Forceps

- ★ZD555R/RB 125
- ★ZD557R/RB 140
- ★ZD559R/RB 160
- ★ZD560R/RB 180
- ★ZD561R/RB 200
- ★ZD562R/RB 250



医用镊 (敷料镊)  
 Dressing Forceps

- ★ZD045R/RB 125
- ★ZD047R/RB 140
- ★ZD049R/RB 160
- ★ZD050R/RB 180
- ★ZD051R/RB 200
- ★ZD053R/RB 220
- ★ZD052R/RB 250
- ★ZD055RB 300



组织镊  
 Tissue Forceps

- ZD063RB 125, 2×3 钩
- ZD064RB 140, 2×3 钩
- ZD065RB 160, 2×3 钩
- ZD066RB 180, 2×3 钩
- ZD067RB 200, 2×3 钩

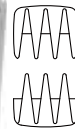

组织镊  
 Tissue Forceps

- ZD068RB 125, 3×4 钩
- ZD069RB 140, 3×4 钩
- ZD070RB 160, 3×4 钩

编码后缀注释: R—电镀 RB—刷光无镀层 Note: R-chrome plated, RB-brushed matt surface



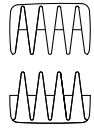

组织镊  
 Tissue Forceps

**ZD071RB**  
 140, 4×5 钩  
**ZD072RB**  
 160, 4×5 钩



组织镊  
 Dissecting Forceps  
 Bayonet-Shaped

★**ZD878MB**  
 140, 枪状有齿  
 ★**ZD870MB**  
 160, 枪状有齿



医用镊  
 Dissecting Forceps

★**ZD025R/RN**  
 125, 精细头  
 ★**ZD027R/RN**  
 140, 精细头  
 ★**ZD029R/RN**  
 160, 精细头



整形镊  
 Adson Dissecting Forceps  
 without Hook

★**ZD222R/RN**  
 125x1.6, 有齿



整形镊  
 Adson Dissecting Forceps  
 with Hook

★**ZD511R/RN**  
 125, 1x2有钩



基础器械  
 Standard Instruments

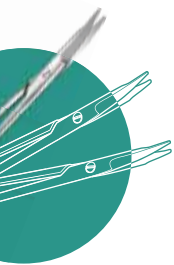

基础器械  
Standard Instruments



手术剪  
Surgical Scissors  
Non-Sterile, Disposable  
**ZC638P**  
140, 尖圆直, 非无菌, 一次性  
140, Straight, Sharp/Blunt



医用镊  
Dissecting Forceps Non-Sterile, Disposable  
**ZD272P**  
200, 带导销, 敷料用, 非无菌, 一次性  
200, With Pin  
**ZD614P**  
145, 1×2钩, 非无菌, 一次性



止血钳  
Haemostatic Forceps  
Straight, Pean  
Non-Sterile, Disposable  
**ZH712P**  
125, 弯全, 非无菌, 一次性 Curved  
**ZH714P**  
150, 直全, 非无菌, 一次性 Straight  
**ZH719P**  
185, 弯全, 非无菌, 一次性 Curved



持针钳  
Needle Holder  
Thick Needle  
Non-Sterile, Disposable  
**ZM274P**  
150, 非无菌, 一次性  
**ZM276P**  
200, 非无菌, 一次性



子弹钳  
Sponge and  
Dressing Forceps  
Non-Sterile, Disposable  
**ZE060P**  
270, 非无菌, 一次性



### FH- I 型缝合器械(ZM100)

#### FH- I suturing instruments set

序号	编 码	名 称	规 格	单 位	数 量
1	ZM234R	持针钳	140,粗针	把	1
2	ZM698R	缝合针	1/2,圆,8×20	包	1
3	ZM666R	缝合针	1/2,弯三角,8×20	包	1
4	ZM654	缝合线	4#	卷	1
5	ZM657	缝合线	7#	卷	1
6	ZD045R	医用镊	125	把	1
7	ZD555R	组织镊	125,不锈钢	把	1
8	ZE012R	组织钳	140	把	1
9	ZC314R	手术剪	140,圆直	把	1
10	ZH144R	止血钳	140,直全	把	1
11	ZH145R	止血钳	140,弯全	把	1
12	ZS549R	不锈钢腰子盘	190×115×25,浅型	个	1
13	ZS520R	不锈钢换药碗	Φ140	个	1



### DB-II型基础外科简易器械包 (ZB102)

#### DB-II minor surgical instruments set (ZB102)

序号	编 码	名 称	规 格	单 位	数 量
1	ZB084R	手术刀柄	4#	把	1
2	ZC344R	手术剪	140,直尖	把	1
3	ZC444R	手术剪	140,弯尖	把	1
4	ZH442R	止血钳	160,直,全齿	把	1
5	ZH443R	止血钳	160,弯,全齿	把	1
6	ZM234R	持针钳	140,直,粗针	把	1
7	ZD557R	组织镊	140,1×2钩	把	1
8	ZD047R	医用镊	140,直	把	1

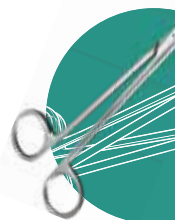

基础器械  
Standard Instruments

