

德国·柯尔曼  
Surgical Instruments Catalog  
手术器械图册

**Klmmmd**  
Karlmed GmbH

**Karlmed GmbH**

Carl-Zeiss-Ring 12  
85737 Ismaning Germany  
Phone: 089-23711160  
Email: office@karlmed.de

中国总代理：新华手术器械有限公司  
山东省淄博市高新区泰美路7号 新华医疗科技园  
电话：0533-3595351  
传真：0533-3595352  
邮编：255086  
网址：[www.shinvasurgical.com](http://www.shinvasurgical.com)

 Made in Germany

# COMPANY PROFILE

## 公司简介



Karlmed GmbH柯尔曼医疗公司坐落于全球医疗器械领域的制造中心—德国。传承了德国高水平的金属加工工艺技术,通过多年的传承与发展,致力于将最高水平的手工技能、机械加工技术和外科医生的临床理念汇集在一起,制造出高度创新的高品质手术器械。

公司秉承品质、创新和服务的宗旨,致力于为外科医生提供完美的手术器械。

# CONTENTS

## 目录

### 神经—显微外科手术器械

- P01 Nano涂层系列显微器械
- P11 显微持针钳(网花圆柄)
- P13 Sensation系列显微器械
- P17 钛合金系列显微器械
- P21 内镜显微剪
- P23 椎板咬骨钳
- P25 手术头架
- P30 动脉瘤夹钳

### 心血管外科手术器械

- P32 手术剪
- P33 超锋利精细手术剪
- P37 持针钳
- P39 血管钳
- P55 钢丝钳/夹持钳
- P57 钛夹钳/胸腔镊
- P58 胸腔镊
- P61 止血夹
- P62 外科牵开器/显微冲洗针
- P63 探针(记忆)
- P64 剥离器
- P65 手术刀柄/拉钩
- P66 吸引管/髓核钳
- P67 手术剪
- P70 夹持钳
- P71 持针钳
- P72 外科牵开器
- P81 乳突牵开器
- P82 打孔器
- P83 拉钩

### 喉显微外科手术器械

- P85 显微喉剪
- P88 喉钳
- P89 显微钩/显微刀
- P90 剥离器/快装手柄
- P91 吸引管

### 专业化手术器械方案

- P92 KU1000颈动脉内膜剥脱手术器械
- P93 KU1002颅内搭桥器械(用于浅部手术) Nano涂层系列
- P93 KU1003颅内搭桥器械(用于中部手术) 钛合金系列
- P94 KU1004颅内搭桥器械(用于中部手术) Nano涂层系列
- P94 KU1005颅内搭桥器械(用于深部手术) Sensation系列
- P95 KU1006喉显微外科手术器械
- P96 KU1007胸腔外科手术器械
- P96 KU1008冠状动脉旁路移植手术器械
- P98 KU1009瓣膜置换手术器械
- P99 瓣膜置换手术器械
- P100 大血管手术器械
- P101 冠状动脉旁路移植手术器械
- P102 微创瓣膜置换手术器械
- P103 微创冠状动脉旁路移植器械
- P104 颈动脉内膜剥脱手术器械



MICRO INSTRUMENTS  
显微器械

— Nano涂层系列

- 低反光率
- 极其坚硬的纳米级涂层
- 超高耐磨耐腐蚀



Automatic lock  
自锁装置

- Secure the suture needle.  
可牢固锁住缝合针。



Golf Handle  
高尔夫手柄

- Cylindrical handle for arbitrary rotation.  
圆柱环形手柄，可任意旋转握持。
- High friction, can be firmly held with gloves.  
高摩擦力，戴手套也能牢固握好。



Plano Handle  
扁柄

- Suitable for microscope use more stable.  
适用显微镜下操作更稳。



Diamonded  
镶钻石

- High hardness diamond;  
高硬度钻石；
- Hold the fine suture needle, suture and tissue firmly;  
牢固抓住精细缝合针、缝线和组织；
- High wear resistance.  
高耐磨性能。











Fine scissors, precise cutting  
精细剪刀, 精准剪切









RONDO GOLF HANDLE

 10mm	 10mm	 10mm	 10mm
* KM0359C	* KM0360C	* KM0365C	* KM0366C
150mm	150mm	180mm	180mm
 10mm	 10mm	 10mm	 10mm
KM1018C	KM1021C	KM1024C	KM1027C
180mm 25°	180mm 45°	180mm 60°	180mm 90°
 10mm			
KM1030C			
180mm 125°			







RONDO GOLF HANDLE  
POINTED

 10mm	 10mm	 10mm
* KM1003C	* KM1006C	* KM1009C
180mm 25°	180mm 45°	180mm 60°
KM1033C	KM1036C	KM1039C
210mm 25°	210mm 45°	210mm 60°
 10mm	 10mm	
* KM1012C	* KM1015C	
180mm 90°	180mm 125°	
KM1042C	KM1045C	
210mm 90°	210mm 125°	

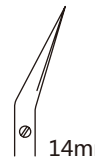





RONDO GOLF HANDLE  
POINTED

 14mm	 14mm	 14mm
<b>KM1004C</b>	<b>KM1007C</b>	<b>KM1010C</b>
180mm 25°	180mm 45°	180mm 60°
<b>KM1034C</b>	<b>KM1037C</b>	<b>KM1040C</b>
210mm 25°	210mm 45°	210mm 60°
 14mm	 14mm	
<b>KM1013C</b>	<b>KM1016C</b>	
180mm 90°	180mm 125°	
<b>KM1043C</b>	<b>KM1046C</b>	
210mm 90°	210mm 125°	



PLANO HANDLE  
POINTED  
YASARGIL

 14mm	 14mm
<b>* KM0517C</b>	<b>* KM0518C</b>
230mm	230mm
 14mm	 14mm
<b>* KM0519C</b>	<b>* KM0520C</b>
230mm	230mm





Micro-Nadelhalter  
Micro Needle Holder

显微持针钳

Micro-Pinzetten  
Micro Tweezer

显微镊

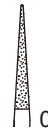





 0.8mm	 1.0mm	 1.2mm
<b>KF0770C</b>	<b>KF0772C</b>	<b>KF0774C</b>
150mm 7/0-8/0	150mm 5/0-6/0	150mm 4/0
<b>* KF0780C</b>	<b>KF0782C</b>	<b>* KF0784C</b>
180mm 7/0-8/0	180mm 5/0-6/0	180mm 4/0
<b>* KF0796C</b>	<b>* KF0798C</b>	<b>* KF0800C</b>
210mm 7/0-8/0	210mm 5/0-6/0	210mm 4/0
<b>KF0812C</b>	<b>KF0814C</b>	<b>* KF0816C</b>
230mm 7/0-8/0	230mm 5/0-6/0	230mm 4/0
 0.3mm	 0.3mm	 0.8mm
<b>* KF0766C</b>	<b>* KF0767C</b>	<b>* KF0781C</b>
150mm 8/0-10/0	150mm 8/0-10/0	180mm 7/0-8/0

RONDO GOLF HANDLE

 DIAMOND





 0.3mm	 0.5mm	 0.7mm	 1.0mm
<b>* KP0940C</b>	<b>KP0942C</b>	<b>KP0944C</b>	<b>KP0946C</b>
150mm	150mm	150mm	150mm
<b>* KP0954C</b>	<b>KP0956C</b>	<b>* KP0958C</b>	<b>KP0960C</b>
180mm	180mm	180mm	180mm
<b>KP0968C</b>	<b>KP0970C</b>	<b>* KP0972C</b>	<b>KP0974C</b>
210mm	210mm	210mm	210mm
<b>KP0982C</b>	<b>* KP0984C</b>	<b>KP0986C</b>	<b>KP0988C</b>
230mm	230mm	230mm	230mm
 0.3mm			
<b>* KP0941C</b>			
150mm			
<b>* KP0955C</b>			
180mm			

RONDO GOLF HANDLE

 DIAMOND

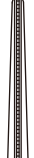

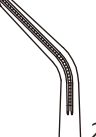
 1.2mm	 1.5mm	 2.0mm
<b>KP1082C</b>	<b>KP1084C</b>	<b>KP1086C</b>
150mm	150mm	150mm
<b>* KP1092C</b>	<b>KP1094C</b>	<b>KP1096C</b>
180mm	180mm	180mm
<b>* KP1102C</b>	<b>KP1104C</b>	<b>* KP1106C</b>
210mm	210mm	210mm
 2.0mm		
<b>* KP1107C</b>		
210mm		

RONDO GOLF HANDLE

 DE BAKEY



 φ1.0mm	 φ1.5mm	 φ2.0mm
<b>* KP1150C</b>	<b>KP1152C</b>	<b>KP1154C</b>
150mm	150mm	150mm
<b>* KP1156C</b>	<b>KP1158C</b>	<b>KP1160C</b>
180mm	180mm	180mm
<b>* KP1162C</b>	<b>KP1164C</b>	<b>KP1166C</b>
210mm	210mm	210mm
<b>KP1168C</b>	<b>KP1170C</b>	<b>KP1172C</b>
230mm	230mm	230mm

RONDO GOLF HANDLE

 DIAMOND



MICRO NEEDLE HOLDER  
显微持针钳(网花圆柄)

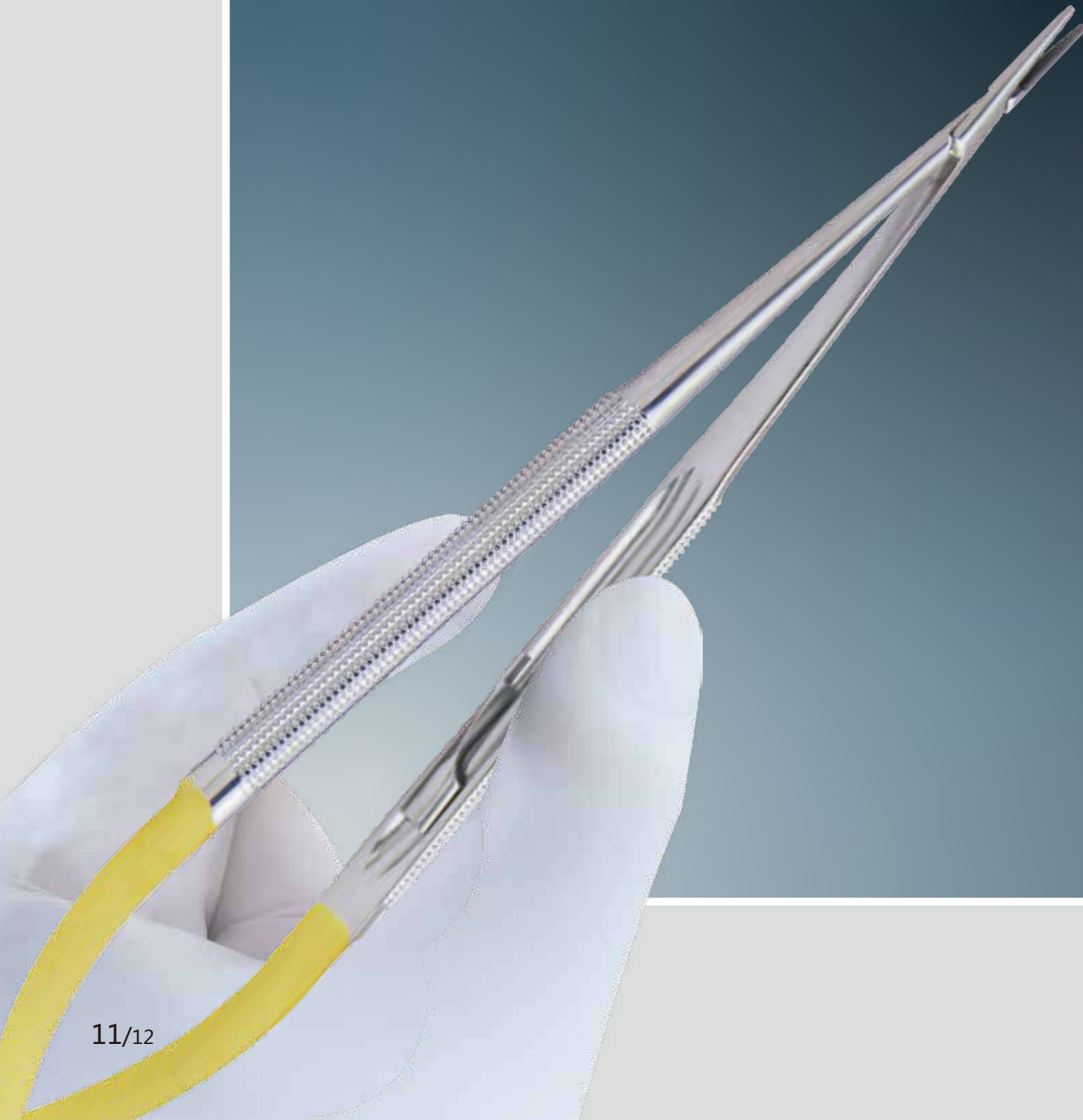

Ergonomic knurled round handle  
滚花圆手柄

- High friction, can be firmly held with gloves.  
高摩擦力，戴手套也能牢固握持。
- Cylindrical handle for improved rotation ability.  
圆柱形手柄，提高旋转能力。

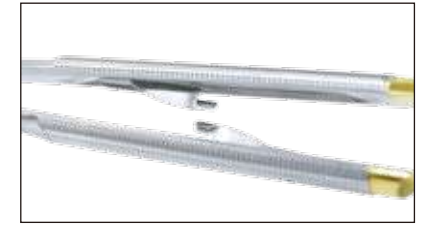

Automatic lock  
自锁装置

- Lock the suture needle  
牢牢锁住缝合针

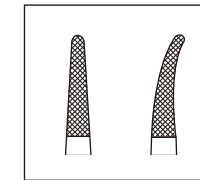

TC insert  
碳钨合金镶片

- High hardness TC insert  
高硬度碳钨合金镶片
- Grab the suture needle firmly  
牢固抓取缝合针

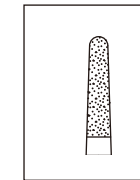

Diamond  
镶钻石

- High wear resistance  
高耐磨性
- High hardness diamond  
高硬度钻石

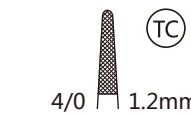

\* KF0532B

180mm

\* KF0548B

210mm

\* KF0564B

230mm

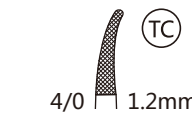

\* KF0533B

180mm

\* KF0549B

210mm

\* KF0565B

230mm

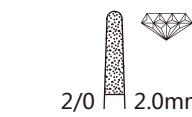

\* KF0486B

230mm

\* KF0502B

250mm

RONDO HANDLE

TC TC-INSERT

Diamond DIAMOND

SENSATION MICRO INSTRUMENTS  
显微器械

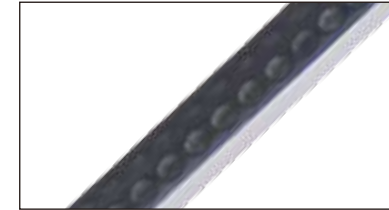

Sensation Golf Handel  
Sensation 高尔夫手柄

- Ergonomic golf handle, good grip feel, wearing gloves can also be safely grabbed.  
人机工程学高尔夫柄，握持手感更佳，戴手套也能安全抓取。
- Polymer material, lighter weight, relieve fatigue.  
高分子材质，分量更轻，缓解术中疲劳。



Gun Type Bayonet Type Design  
枪状刺刀型

- Unblocked field of view.  
术中不遮挡手术视野。
- Suitable for fine use under microscope.  
适用于显微镜下精细操作。

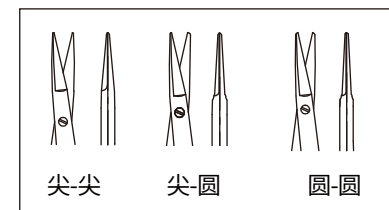

Specialized work Jaws  
专业化工作端设计

- Jaws design with different shapes, Suitable for shear and dissection in surgery.  
不同形状剪切刃口设计，满足术中锋利剪切剥离，保护组织的多种操作需求。







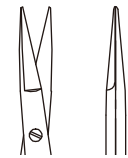

Micro-Schere  
Micro Scissors

显微剪

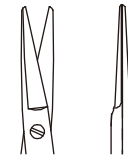
Micro-Nadelhalter/Micro-Pinzetten  
Micro Needle Holder/Micro Tweezer

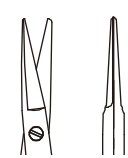
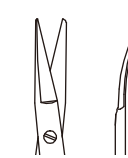
显微持针钳/显微镊



- |  |  |  |
|--|--|--|
| <br>* KM0182B<br>210mm<br>尖-尖   | <br>* KM0183B<br>210mm<br>尖-尖   | <br>* KM0254B<br>210mm<br>圆-圆   |
| <br>* KM0255B<br>210mm<br>圆-圆   | <br>* KM0326B<br>210mm<br>尖-圆   | <br>* KM0327B<br>210mm<br>尖-圆   |
| <br>* KM0191B<br>230mm<br>尖-尖 | <br>* KM0192B<br>230mm<br>尖-尖 | <br>* KM0335B<br>230mm<br>尖-圆 |
| <br>* KM0336B<br>230mm<br>尖-圆 |  |  |



PLANO PEEK HANDLE  
SENSATION

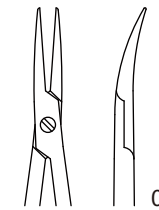

- |   |
|---|
| <br>* KF1493B<br>210mm |
|---|

PLANO PEEK HANDLE  
SENSATION

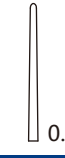
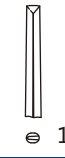

- |   |
|---|
| <br>* KP2142B<br>210mm   |
| <br>* KP2350B<br>210mm   |
| <br>* KP2198B<br>230mm |

PLANO PEEK HANDLE  
SENSATION



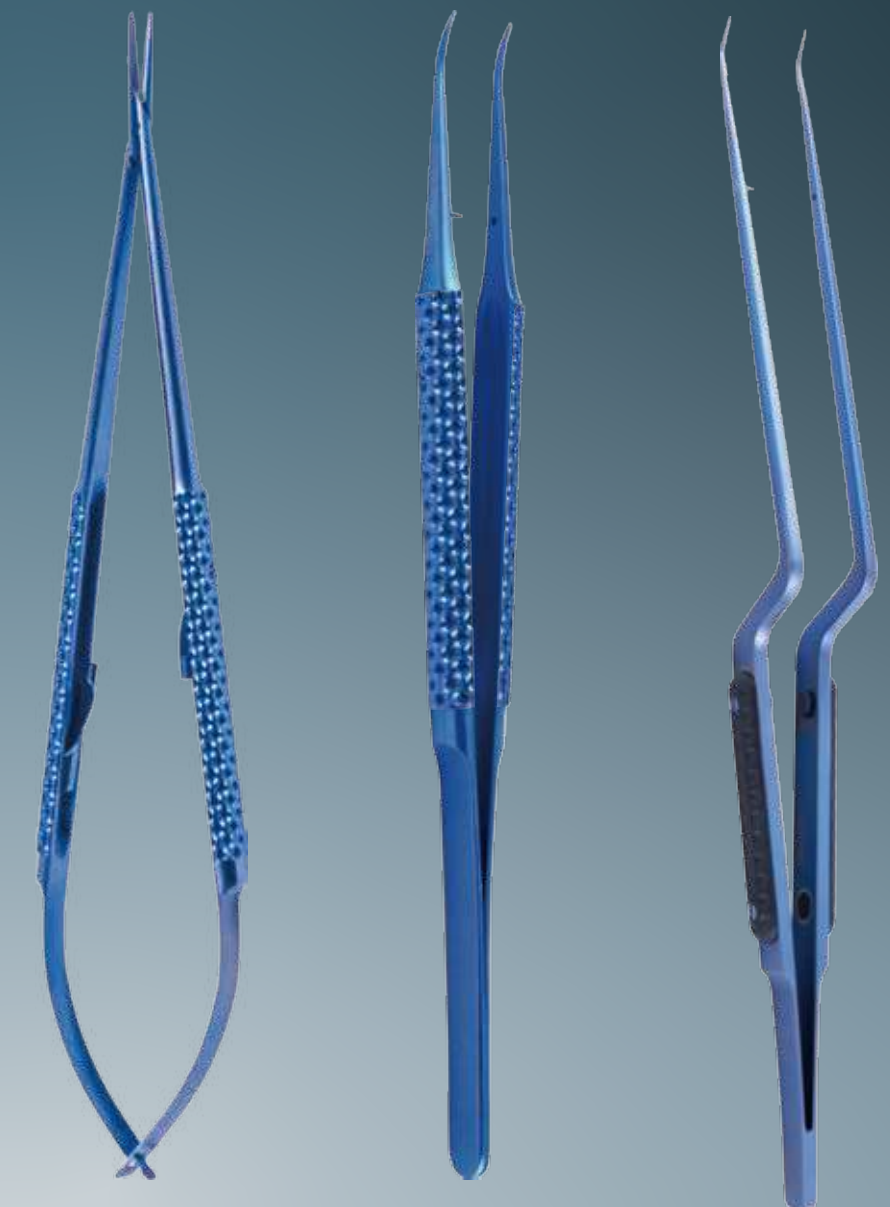

TITANIUM MICRO INSTRUMENTS

超轻显微器械

— 钛合金系列

- 钛合金质量轻
- 有效缓解术中疲劳



**Golf Handle**  
高尔夫圆柄

- Cylindrical handle for arbitrary rotation.  
圆柱形手柄，提高旋转灵活操作。
- High friction, can be firmly held with gloves.  
高摩擦力，戴手套也能牢固握持。



**Diamond**  
镶钻石

- Set with high hardness diamond, high wear resistance.  
镶高硬度钻石，高耐磨性。
- Hold a fine needle, suture, or tissue firmly.  
牢固抓住精细缝针、缝线或组织。



0.3mm * KP1309T 150mm	0.3mm * KP1308T 150mm	φ1mm * KP1528T 150mm
* KP1323T 180mm	* KP1322T 180mm	* KP1534T 180mm

RONDO GOLF HANDLE

DIAMOND  
TITANIUM



φ1mm * KP1546T 230mm	0.3mm * KP1350T 230mm	0.3mm * KP1351T 230mm
----------------------------	-----------------------------	-----------------------------

RLANO PEEK HANDLE

DIAMOND  
TITANIUM  
SENSATION



8/0-10/0 0.3mm * KF1812T 180mm	8/0-10/0 0.3mm * KF1813T 180mm
--------------------------------------	--------------------------------------

RONDO GOLF HANDLE

DIAMOND  
TITANIUM



## MICRO SCISSORS 显微剪

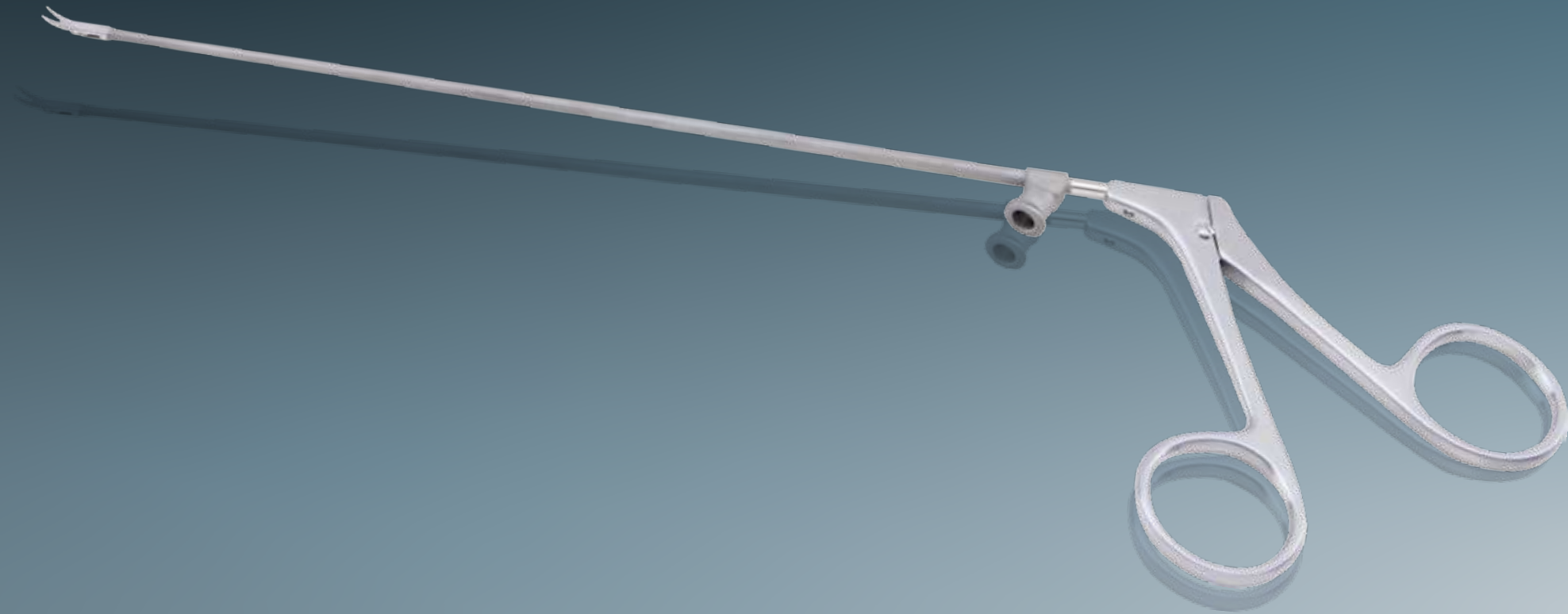

### Fine working Jaws 精细工作头

A variety of specifications of the working head can fully adapt to different environment, to achieve intraoperative stripping, shearing and other operations, the shape of the working jaws, joints are smooth treatment, to avoid intraoperative scratches.

多种规格的工作头可充分适应不同的手术环境，实现术中剥离、剪切等操作，工作头外形、关节处均作光滑处理，避免术中划伤组织。



### Taper, coat working rod 锥度涂层工作杆

The rod part adopts taper tube design, fine size and reduce the shaking of the internal connecting rod, to maintain the stability of the working head, and on the surface of the frosting treatment, to avoid dazzling, dazzling.

杆部采用锥度管设计，精细尺寸并减小内部连杆晃动，保持工作头稳定，并在表面进行磨砂处理，避免术中炫光、刺眼。



### Luer Connector 鲁尔接口

The front of the handle is equipped with a flushing joint, which is convenient for cleaning and eliminating the internal cavity of the instrument, thus prolonging the service life and ensuring the quality of the instrument is always maintained at the first-class level.

手柄前方配有冲洗接头，便于器械管腔内部的清洁、消杀，从而延长使用寿命，保证器械品质始终维持一流水准。



\* KM1082C  
180mm Straight 直



\* KM1083C  
180mm Right 右弯



\* KM1084C  
180mm Left 左弯



\* KM1085C  
180mm Up 上弯

DETACHABLE KERRISON PUNCH  
椎板咬骨钳·可拆卸式

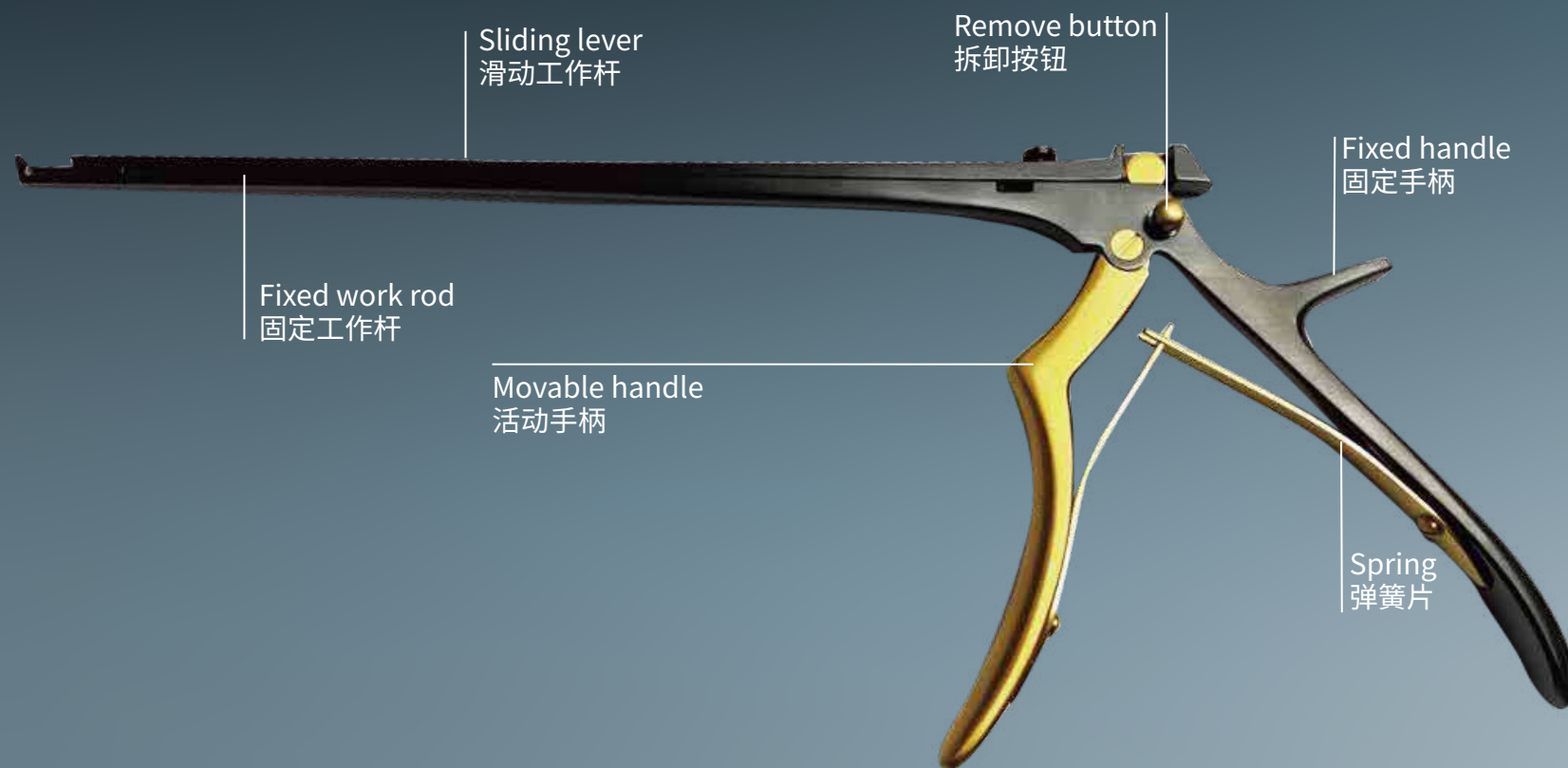

① Hold the Movable Handle  
握紧活动手柄

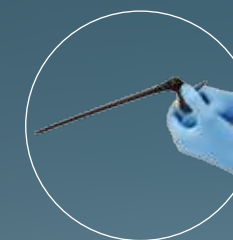

② Press on Remove button  
按住拆卸按钮



③ Press on Remove button,  
Release Movable handle  
按住拆卸按钮的同时松开  
活动手柄

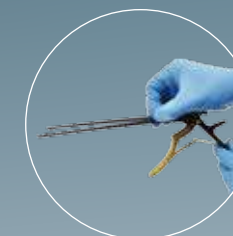

④ Open the Sliding Lever  
打开滑动工作杆

Disassembly diagram  
拆卸示意图

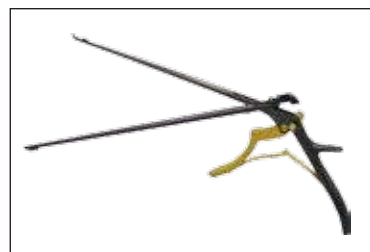

Detachable  
可拆卸式结构

- Easy to clean.  
术后清洗更方便。



Nano Coating  
Nano涂层

- Low reflectance  
低反光率
- The coating is extremely hard  
涂层及其坚硬
- Ultra-high wear resistance  
超高的耐磨性



Multi-angle working Jaws  
多角度工作头

- Ultra-thin cutting Jaws , Cutting precision  
超薄刃口设计, 咬切精准
- Excellent Cutting  
优良的咬切性能

\* KC1389C

230mm  
90°  
Jaws 2mm

\* KC1410C

230mm  
110°  
Jaws 3mm

\* KC1430C

230mm  
130°  
Jaws 3mm

\* KC1388C

230mm  
90°  
Jaws 1mm

\* KC1390C

230mm  
90°  
Jaws 3mm

\* KC1411C

230mm  
110°  
Jaws 4mm

\* KC1431C

230mm  
130°  
Jaws 4mm

\* KC1428C

230mm  
130°  
Jaws 1mm

\* KC1409C

230mm  
110°  
Jaws 2mm

\* KC1429C

230mm  
130°  
Jaws 2mm

\* KC1432C

230mm  
130°  
Jaws 5mm

## HEAD RESTING SYSTEM 手术头架系统

A compact structure to prevent accidental release.  
防止意外脱开的锁紧装置

Skull fixation tripod of different sizes for adults and children, The two models can be quickly exchanged and adapted

适配成人与儿童的不同尺寸的颅骨固定三脚架，两种型号可快速调换适配

Titanium skull positioning nail Reusable  
钛合金颅骨定位钉可重复使用的

Embedded insulation ring ensures that the head frame is insulated from the operating bed

嵌入式绝缘环，保证头架与手术床绝缘

Safety structure to prevent the head frame from accidentally disconnecting  
加配防脱开保险装置，防止头架意外脱开

Two metal supports, can be used as hand support, flexible operation  
两个金属支架，可用作手托，灵活操作

适配 Leylalviridis

Navigation adapter, can be used to adjust the hand support direction, height  
导航适配器，可用于调节手托的方向、高度

Universal joint: can rotate and tilt 360°  
方向关节：可360°旋转和倾斜

The whole body adopts high strength aluminum alloy material, lighter weight, high hardness Nano coating

Silicone Head Pad With traction function  
适配硅胶头拖具备牵引功能





\* KH0000C  
MF-I型 涂层



\* KH0005C  
头托牵引架 涂层



\* KH0003B  
牵开臂式 牵开系统



\* KH0002P  
MF-III型 碳纤维



\* KR0382B  
RZ- I 型 软轴牵开器



\* KR0383B  
RZ- II 型 软轴牵开器



\* KR0402B  
转接器, I 型软轴牵开器



\* KR0403B  
转接器, II型软轴牵开器



\* KR0404B  
转接器, III型软轴牵开器



\* KR0405B  
转接器, IV型软轴牵开器



\* KR0781B  
长200, 头宽7/9, 带刻度

\* KR1039B  
长200, 头宽11/13, 带刻度

\* KR1040B  
长200, 头宽15/18, 带刻度

\* KR1218B  
长200, 头宽11/13, 带凹

\* KR1217B  
长200, 头宽15/18, 带凹



\* KR0406B  
转接器, V型软轴牵开器



\* KR0407B  
转接器, VI型软轴牵开器



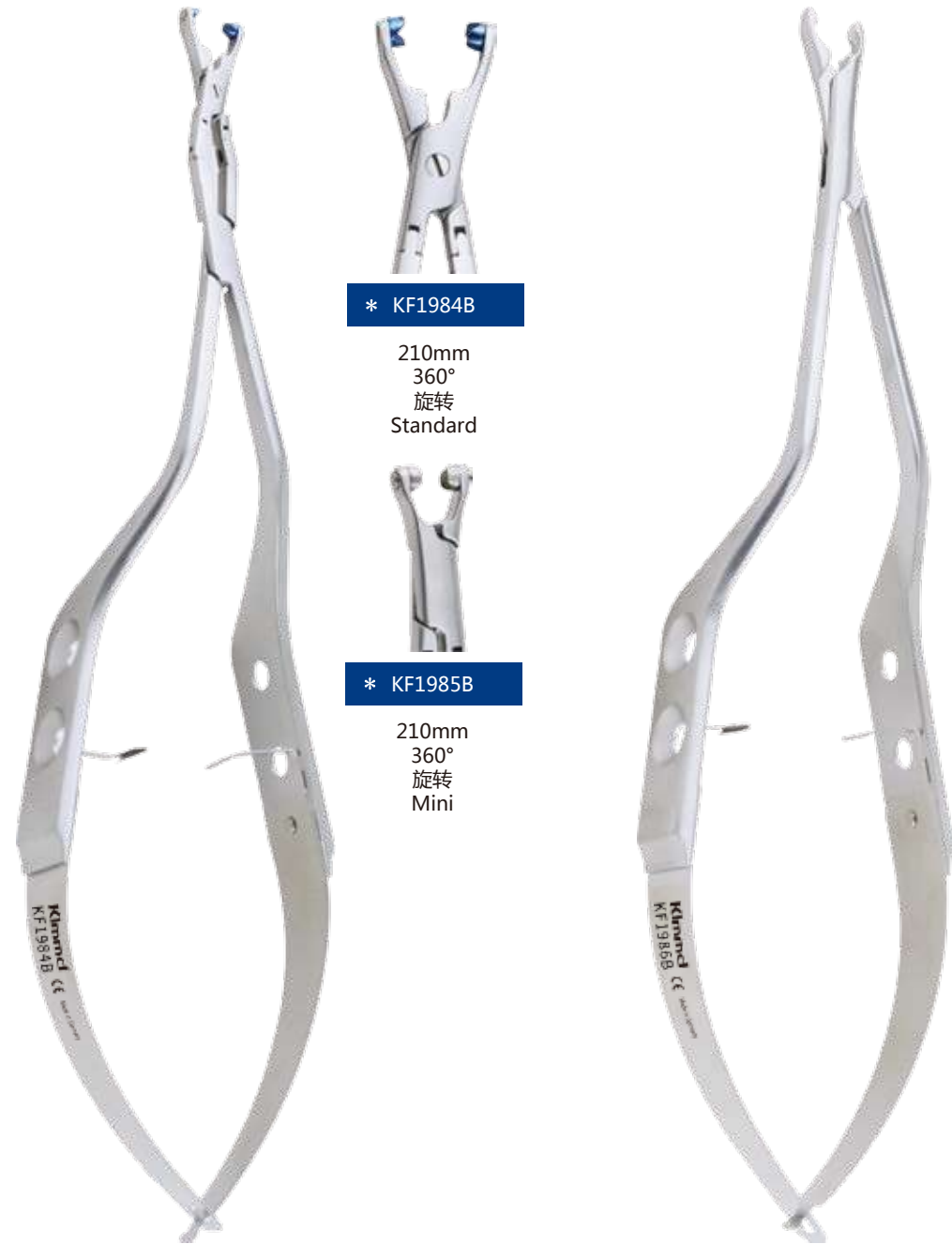

\* KF1984B

210mm  
360°  
旋转  
Standard

\* KF1985B

210mm  
360°  
旋转  
Mini

\* KF1986B

210mm  
Standard

\* KF1987B

210mm  
Mini



\* KS0119B

245mm  
瓣膜手术

METZENBAUM FINO  
S-SHAPE HANDLE



超  
锋  
利  
精  
细  
手  
术  
剪  
  
SUPER SHARP CISSORS



**Fine anti-slip teeth**  
精细防滑齿

Increase the friction between the tissue and the cutting edge, prevent the slip of the shear tissue, and the shear effect is better.  
增大组织与刃口摩擦力，防治剪切组织滑落，剪切效果更佳。



**The Blade TC-insert**  
刃口镶嵌硬质合金

High hardness Blade, prolong the use of life.  
高硬度刃口，延长使用寿命。



SUPER CUTTING

TC-INSERT

KS0059B	KS0071B
145mm	145mm
* KS0061B	* KS0073B
180mm	180mm
* KS0063B	KS0075B
200mm	200mm
* KS0066B	KS0077B
230mm	230mm

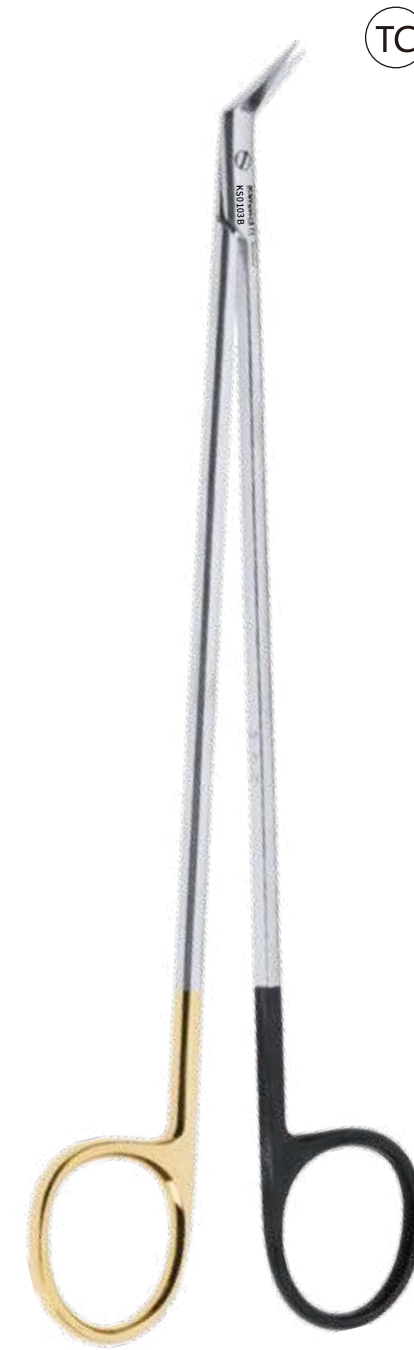

SUPER CUTTING

TC-INSERT

KS0103B	* KS0113B	* KS0105B
180mm 25°	180mm 45°	180mm 60°
KS0108B	KS0109B	KS0110B
180mm 25°	180mm 45°	180mm 60°
KS0106B	KS0107B	
180mm 90°	180mm 125°	
KS0111B	KS0112B	
180mm 90°	180mm 125°	

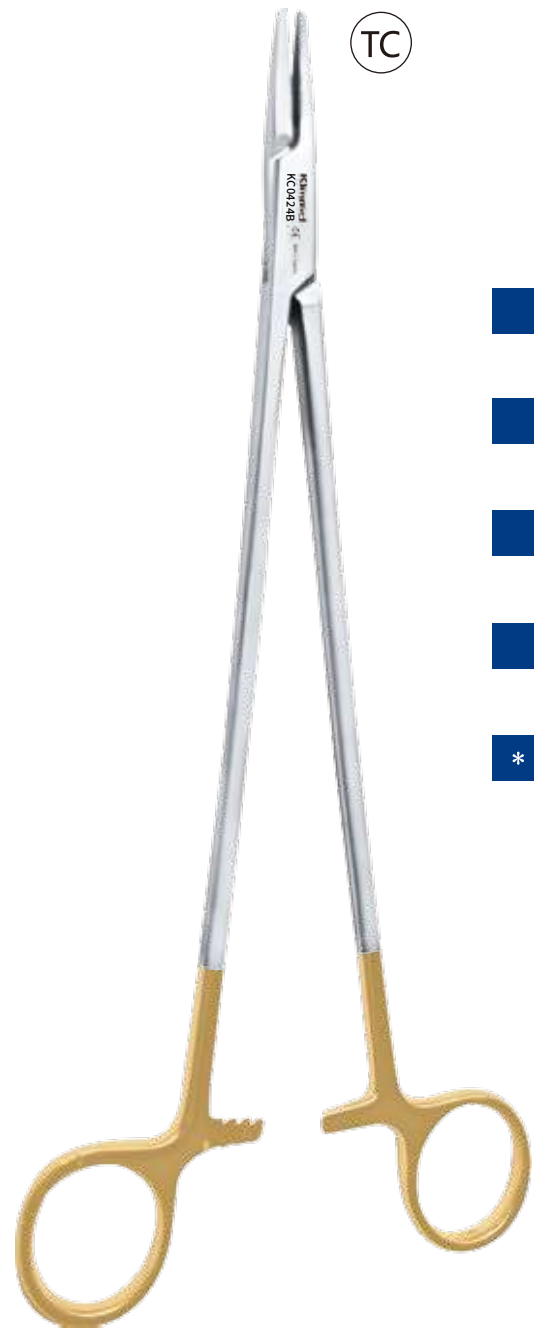

TC-INSERT

TC

0.5mm up to 3/0	0.4mm 4/0-6/0	0.2mm 6/0-10/0
KC0424B 160mm	KC0433B 160mm	KC0451B 160mm
KC0425B 180mm	* KC0434B 180mm	KC0452B 180mm
KC0426B 200mm	KC0435B 200mm	* KC0453B 200mm
KC0427B 220mm	KC0436B 220mm	KC0454B 220mm
* KC0428B 250mm	KC0437B 250mm	KC0455B 250mm



TC-INSERT

TC

KC0394B 210mm
* KC0395B 230mm
KC0396B 270mm

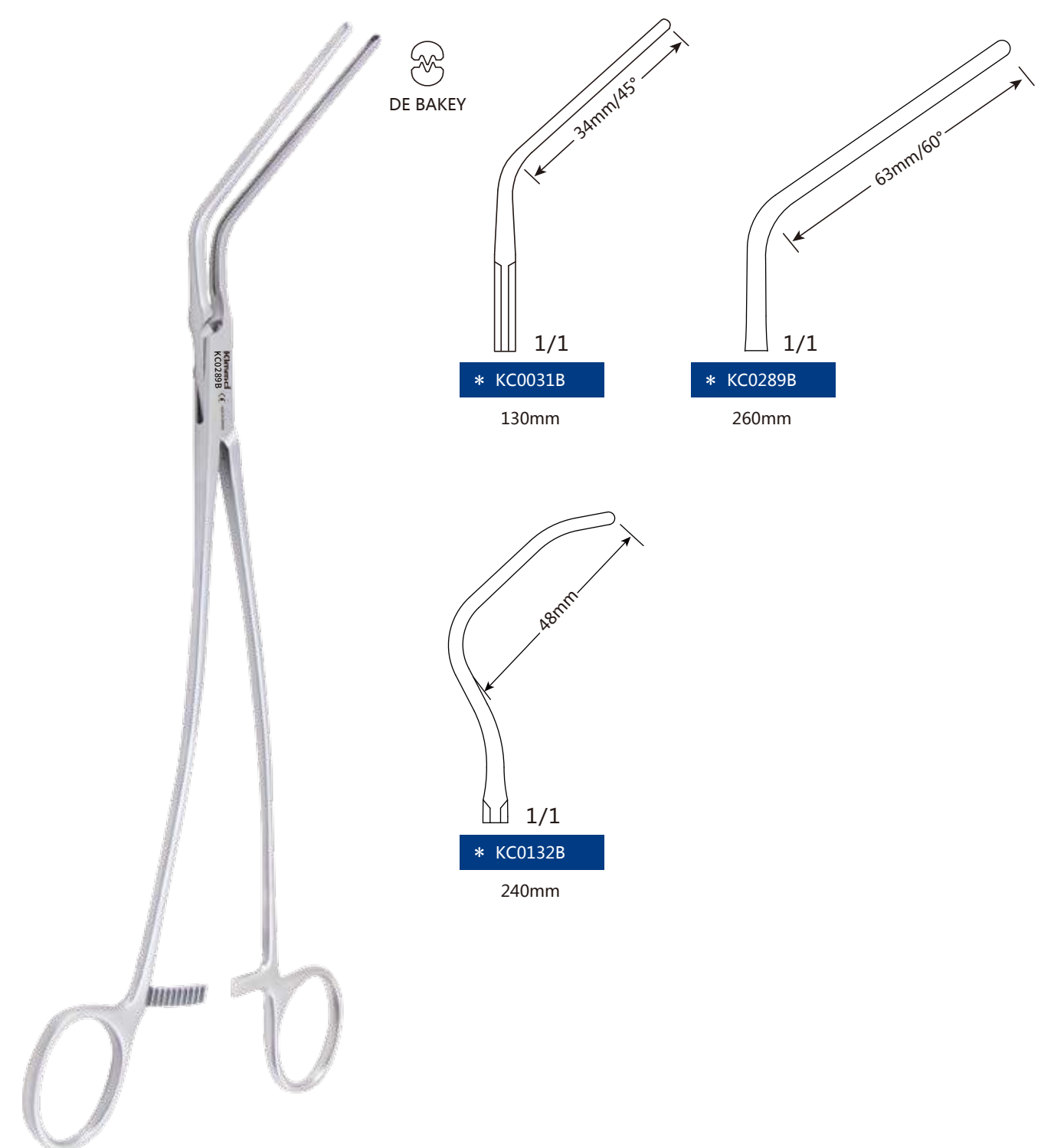





\* KC0287B  
200mm

\* KC0288B  
200mm

LAMBERT-KAY

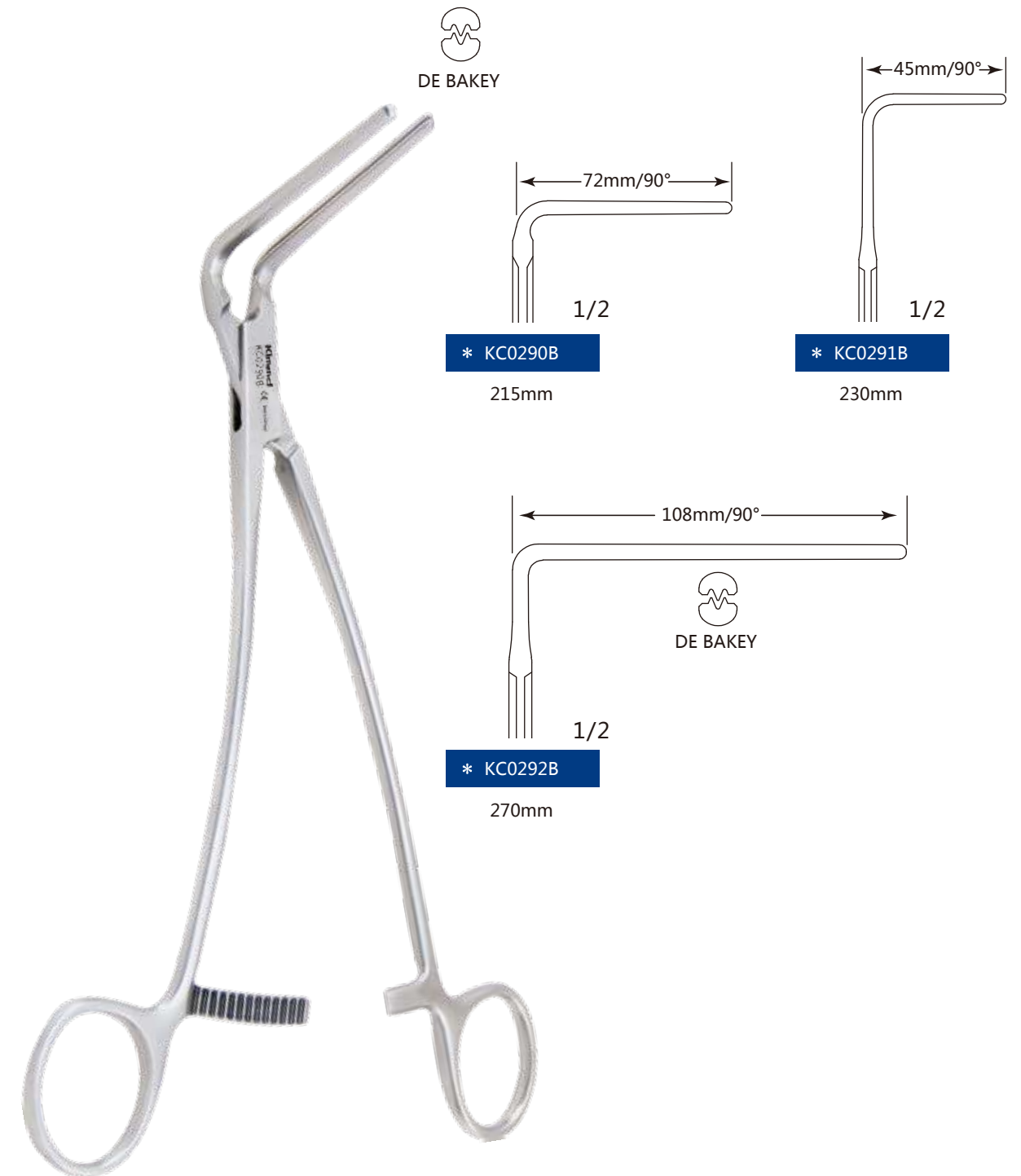

\* KC0290B  
215mm

\* KC0291B  
230mm

\* KC0292B  
270mm

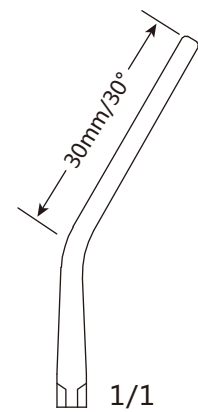

\* KC0311B  
160mm

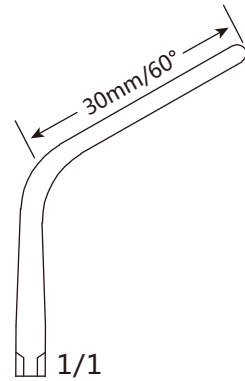

\* KC0312B  
160mm

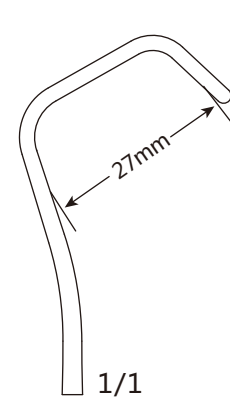

KC0048B  
180mm

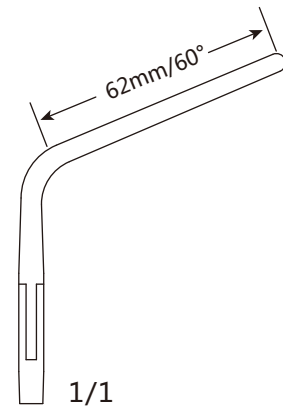

KC0075B  
215mm

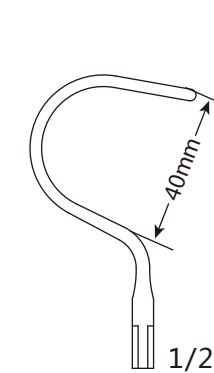

KC0052B  
240mm

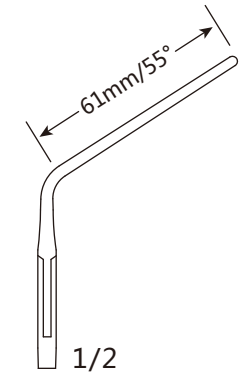

KC0289B  
260mm

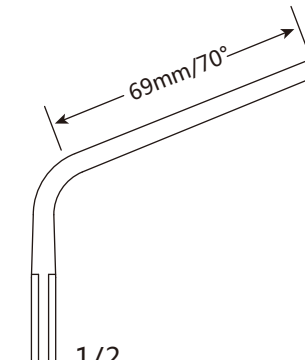

KC0110B  
255mm

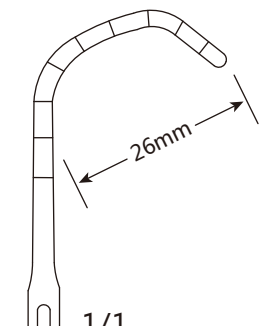

KC0308B  
145mm

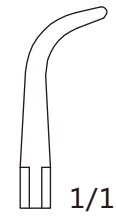

\* KC1525B

130mm  
105°

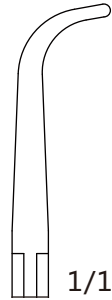

\* KC1553B

160mm  
105°

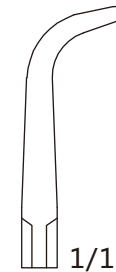

\* KC1526B

180mm  
105°

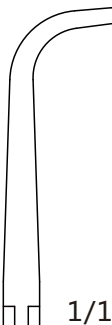

\* KC1527B

200mm  
105°

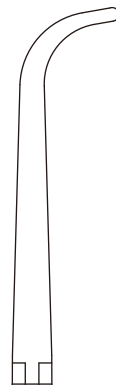

\* KC1528B

230mm  
105°

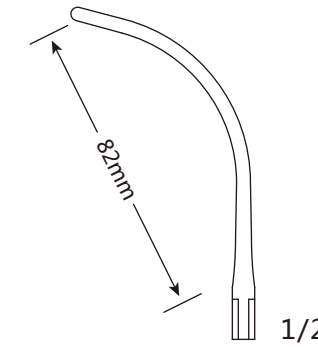

\* KC0058B

250mm

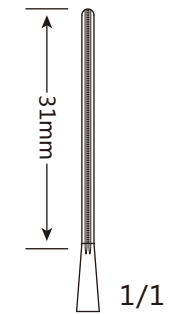

KC0014B

125mm

KC0016B

150mm

KC0018B

165mm

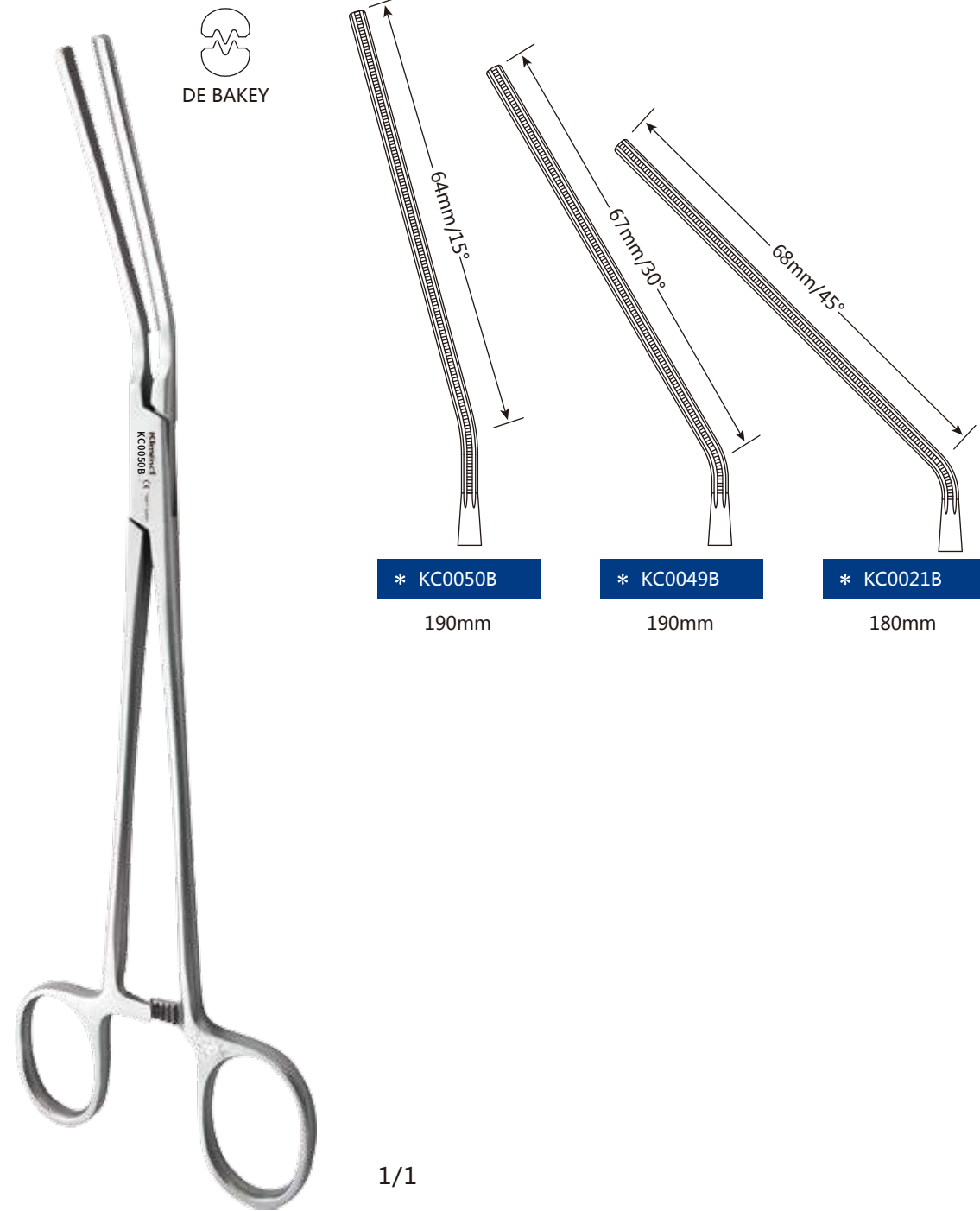







COOLEY

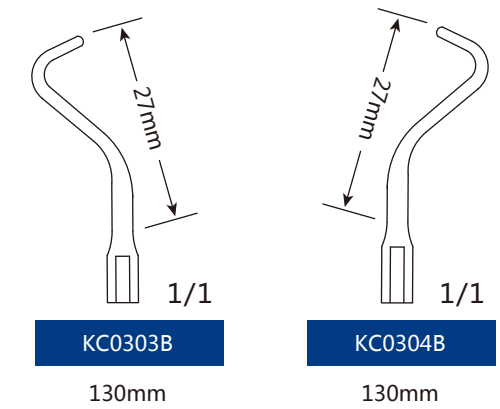
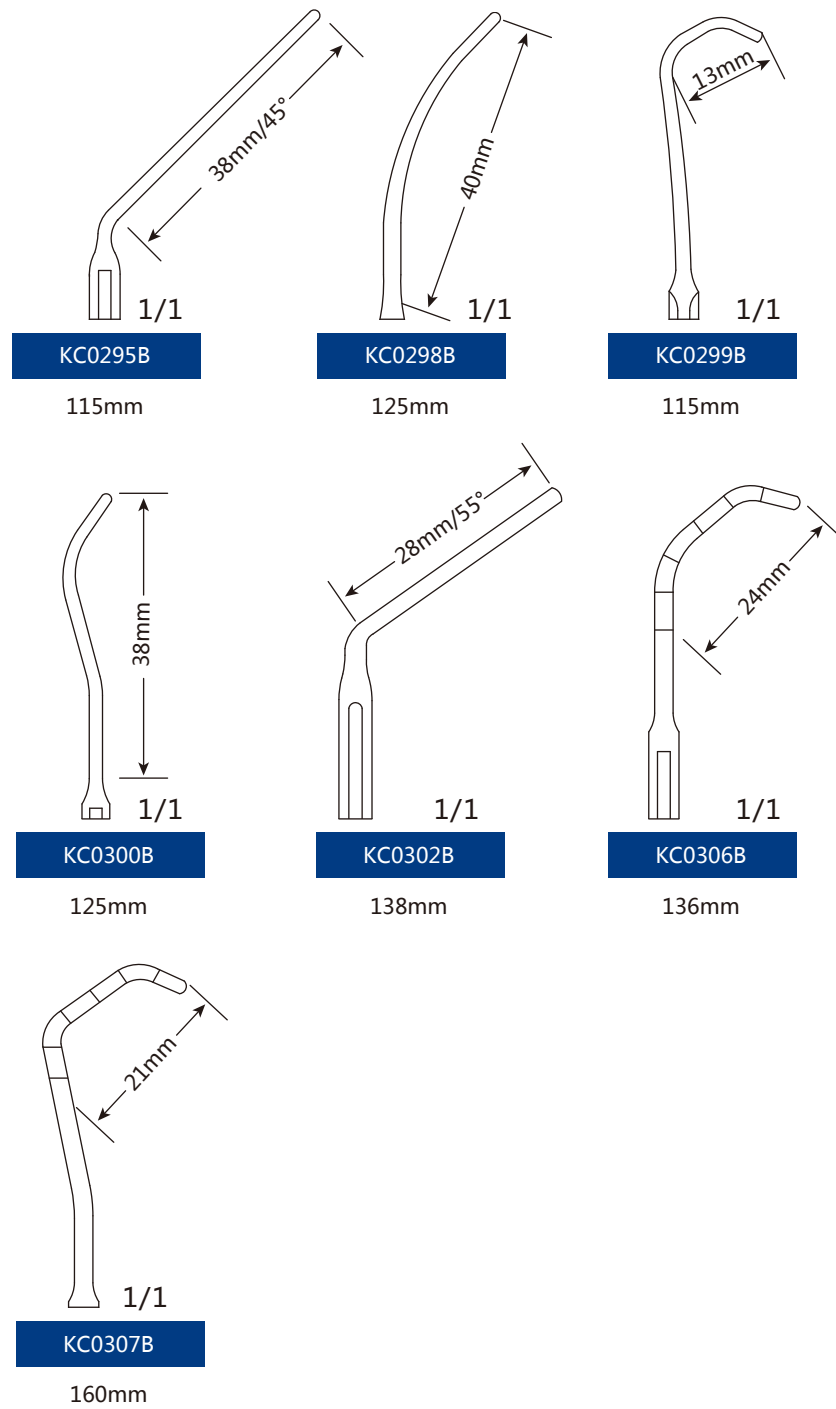



Drahtklemme/Haltezange

钢丝钳

Wire Clamp/Holding Forceps

夹持钳



TC

\* KC0004B

200mm

TC-INSERT



\* KC0337B

220mm

Clip Applikator  
Clip Applier

钛夹钳

Clip Applikator/Herz-Kreislauf-Pinzetten  
Clip Applier/Cardiovascular Tweezer

钛夹钳/胸腔镊



\* KC1490B  
200mm  
小号  
(适用泰利福款钛夹)



KC1491B  
200mm  
小号宽槽  
(适用泰利福款钛夹)



\* KC1492B  
200mm  
中号  
(适用泰利福款钛夹)



\* KP2631B  
230mm  
Jaws 2mm







\* KP2572B  
205mm  
\* KP2573B  
255mm



RLANO HANDLE

DE BAKEY



 1.2mm	 1.5mm	 2.0mm
<b>KP2615B</b>	<b>KP2600B</b>	<b>KP2605B</b>
180mm	180mm	180mm
* <b>KP2613B</b>	<b>KP2593B</b>	<b>KP2636B</b>
200mm	200mm	200mm
<b>KP2628B</b>	<b>KP2598B</b>	<b>KP2599B</b>
210mm	220mm	220mm
<b>KP2611B</b>	<b>KP2502B</b>	* <b>KP2507B</b>
240mm	240mm	240mm
 2.5mm	 2.0mm	
<b>KP2604B</b>	<b>KP2584B</b>	
180mm	180mm 40°	
<b>KP2596B</b>	<b>KP2591B</b>	
200mm	200mm 40°	
<b>KP2603B</b>	<b>KP2583B</b>	
220mm	220mm 40°	
<b>KP2606B</b>	* <b>KP2590B</b>	
250mm	250mm 40°	







RLANO HANDLE

DE BAKEY

TC-INSERT



 1.5mm	 2.0mm	 2.7mm	 3.5mm
* <b>KP2527B</b>	* <b>KP2530B</b>	<b>KP2533B</b>	<b>KP2535B</b>
195mm	195mm	195mm	195mm
<b>KP2528B</b>	<b>KP2531B</b>	<b>KP2534B</b>	<b>KP2536B</b>
240mm	240mm	240mm	240mm



Atraumatischer Clip  
Atraumatic Clip

止血夹

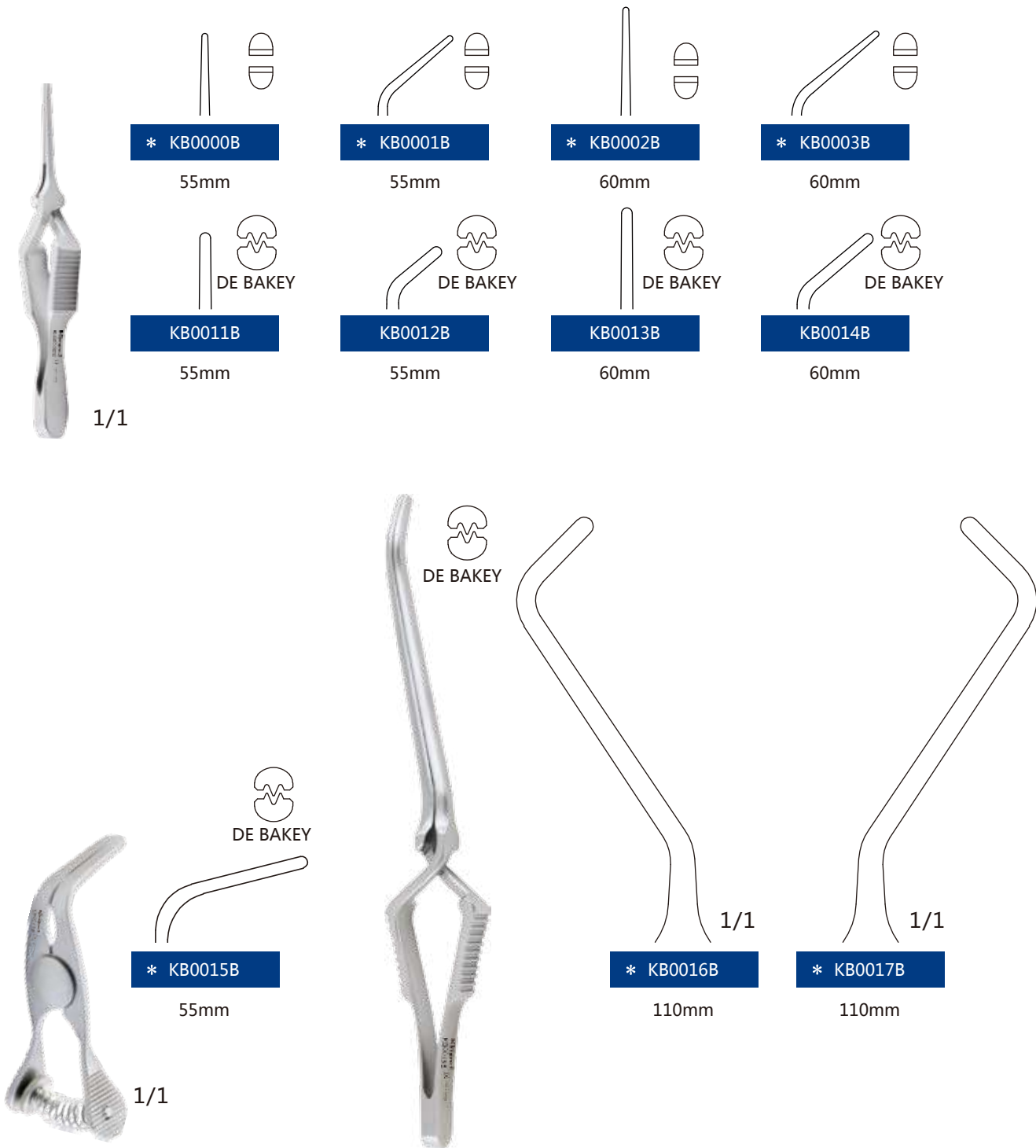

Atraumatischer Clip/Selbsthaltender Retraktor/Schiffsausrichtung Nadel  
Atraumatic Clip/Self Retaining Retractor/Vessel Irrigation Needle 止血夹/外科牵开器/显微冲洗针

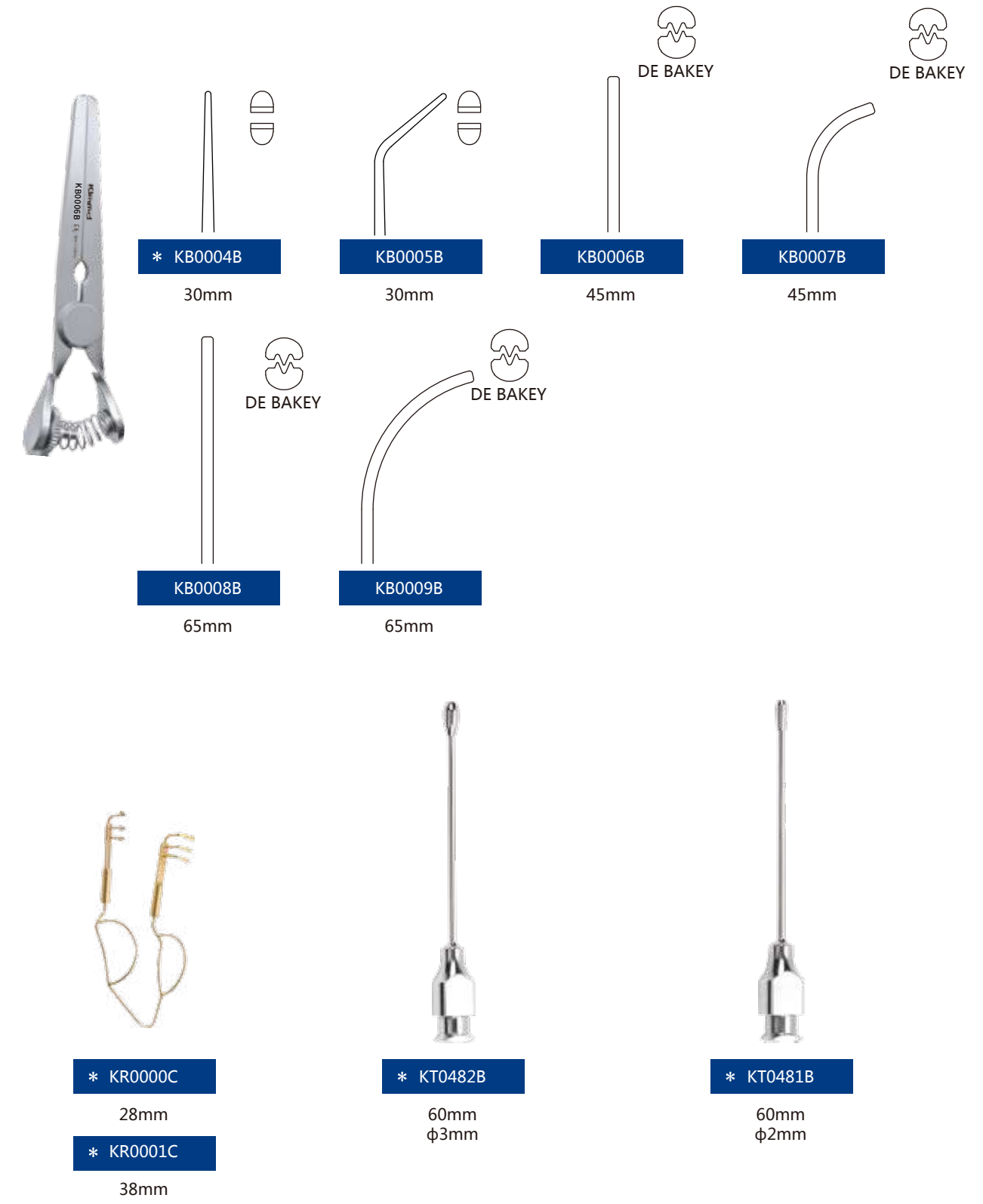

Sonde  
Probe









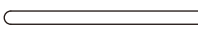

探针

Periosteal Raspatoris/Stripper

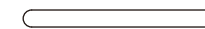
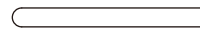
骨膜剥离器/剥离器



MEMORY 记忆合金

 <b>* KN0016B</b> 180mm φ1mm	 KN0017B 180mm φ1.25mm	 <b>* KN0018B</b> 180mm φ1.5mm	 KN0019B 180mm φ1.75mm
 <b>* KN0020B</b> 180mm φ2.0mm	 KN0021B 180mm φ2.25mm	 <b>* KN0022B</b> 180mm φ2.5mm	 KN0023B 180mm φ3.0mm
 KN0024B 180mm φ3.5mm	 KN0025B 180mm φ4.0mm	 KN0026B 180mm φ4.5mm	 KN0027B 180mm φ5.0mm



**\* KD0000B**  
180mm  
Jaws 1mm/2mm  
**\* KD0001B**  
180mm  
Jaws 3mm/4mm



**\* KD0136C**  
240mm  
Jaws 1.5mm/3mm  
**\* KD0134C**  
240mm  
Jaws 2mm/4mm



**\* KR0416B**  
210mm  
φ1mm  
90°

Skalpel Igriff/Retraktor  
Scalpel Handle/Retractor

手术刀柄/拉钩



\* KK0502B

155mm



\* KR0590B

240mm  
Jaws 4mm

\* KR0591B

240mm  
Jaws 8mm

Saugrohr/Laminektomie Pinzetten  
Suction Tube/Laminectomy Forceps

吸引管/髓核钳



\* KT0000B

280mm



\* KC0494B

260mm  
Jaws 5mm

\* KC0498B

300mm  
Jaws 3mm



### Handle 手柄

The new pen-holding handle combines ergonomics and cambered surface design to improve the surgical feel of doctors. At the same time, it can effectively relieve hand fatigue of doctors.

全新的握笔式手柄结合人体工程学，弧面设计全方位提升医生的手术使用手感。同时有效缓解医生手部疲劳。



### Luer 鲁尔接头

The upper part of the handle is equipped with a flushing joint, which is convenient for cleaning and eliminating the internal cavity of the instrument, thus prolonging the service life.

手柄上方配有冲洗接头，便于器械管腔内部的清洁、消杀，从而延长使用寿命。



### Scissors 手术剪

The cutting edge of the scissors is sharp and accurate, which can accurately cut the tissue or suture line. At the same time, the coating treatment ensures that the cutting edge is always sharp.

剪刀刃口锋利、配合精准，可对组织或缝合线准确完成剪切，同时镀层处理保证刃口始终锋利。



### Forceps 夹持钳

A variety of specifications of the forceps head can meet different surgical needs, with a variety of tooth shapes can realize the tissue without damage grasp and maintain stability.

多种规格的钳头可满足不同的手术需求，搭配各种齿形可实现对组织的无损伤抓取并保持稳定。



### Needle Holder 持针钳

The working head is inlaid with hard alloy sheet or emery coating, and the suture needle can be held stably during the operation to avoid needle rotation; At the same time, the shape of the working head and joints were smoothed to avoid the intraoperative hook suture.

工作头镶嵌硬质合金片或金刚砂涂层，手术中可稳定夹持缝合针避免转针现象；同时工作头外形、关节处均作光滑处理，避免术中钩拉缝合线。



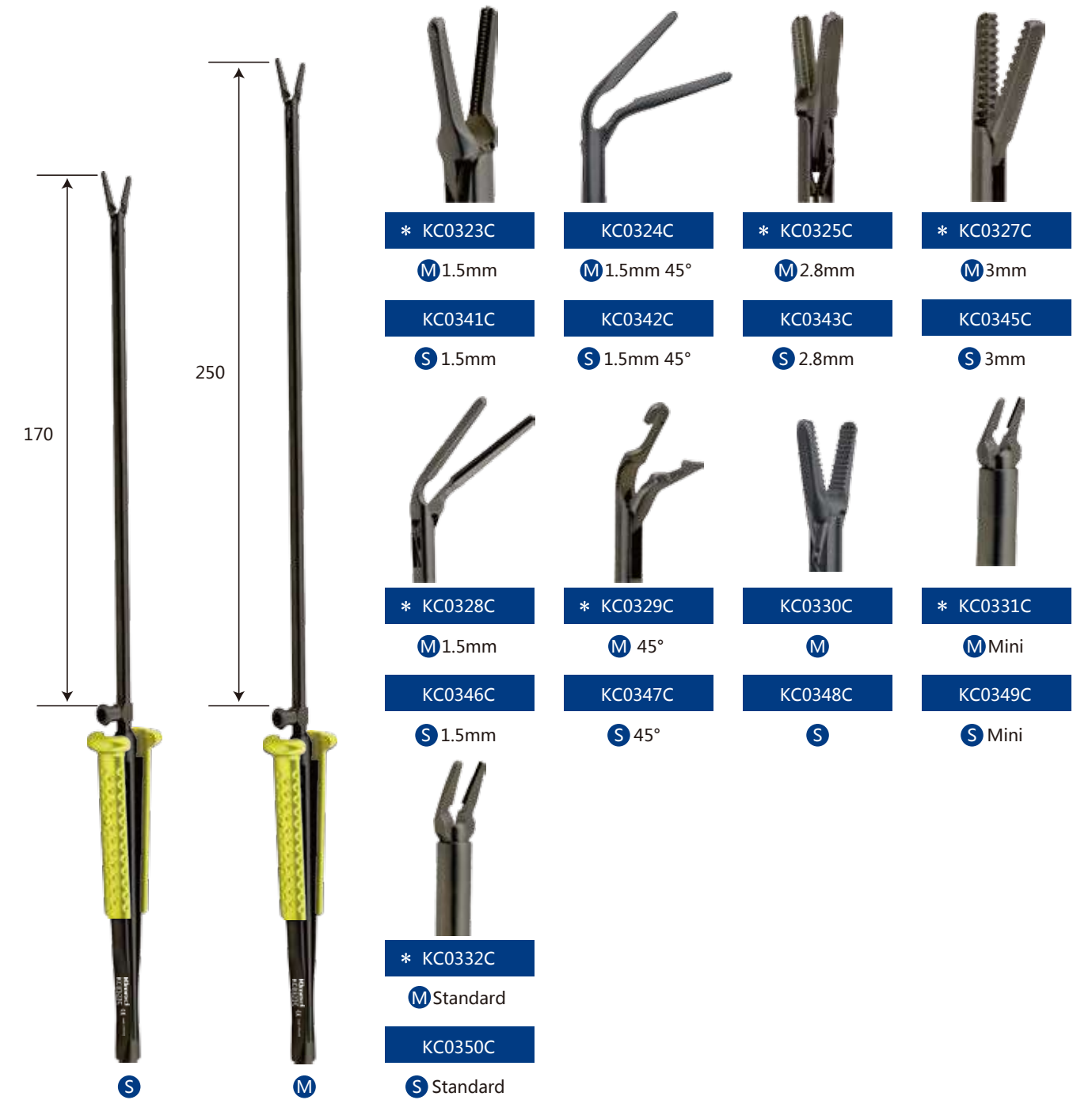
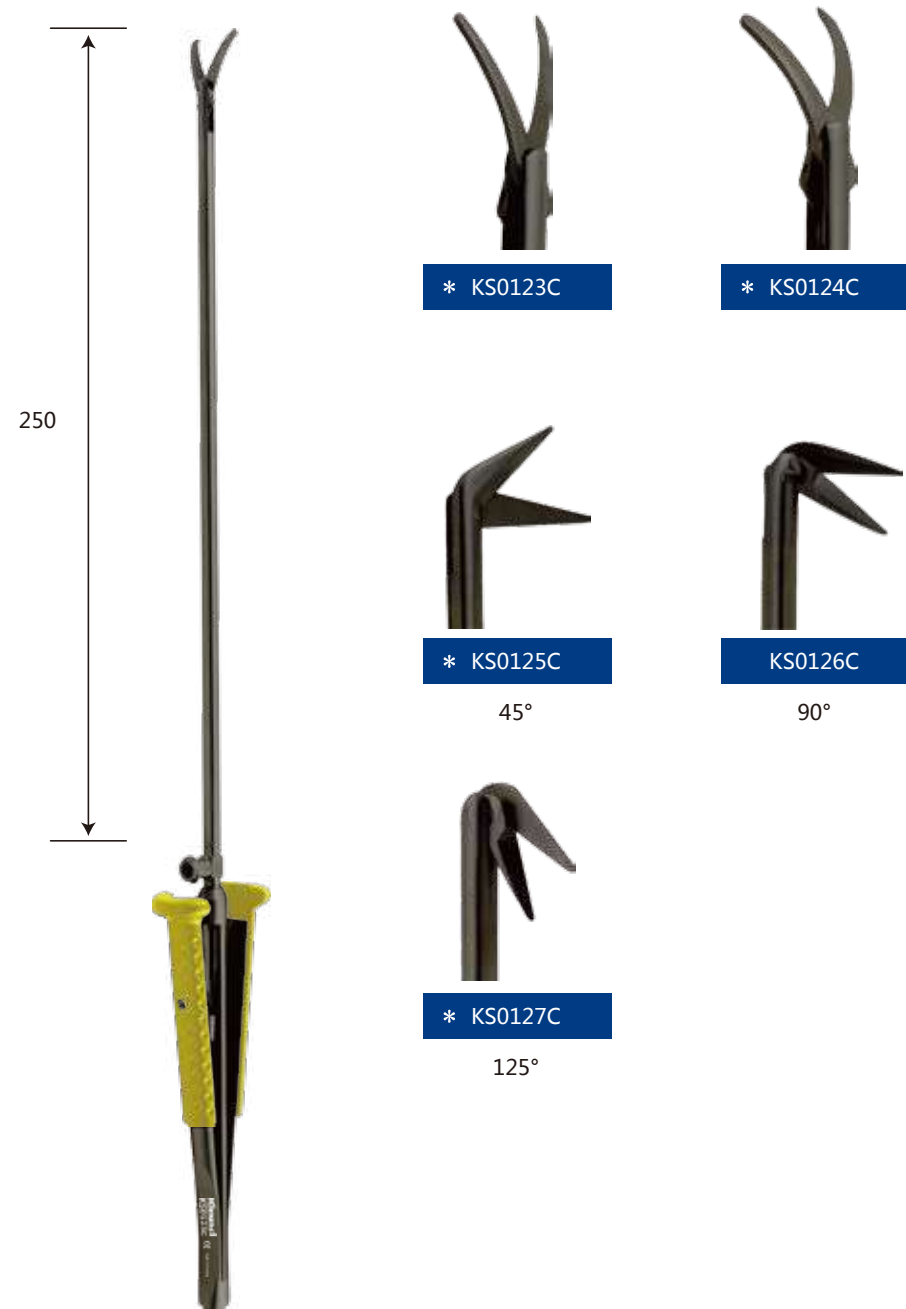

Nadelhalter/Scalpellgriff  
Needle Holder/Scalpel Handle

持针钳/手术刀柄

Selbsthaltender Retraktor  
Self Retaining Retractor

外科牵开器

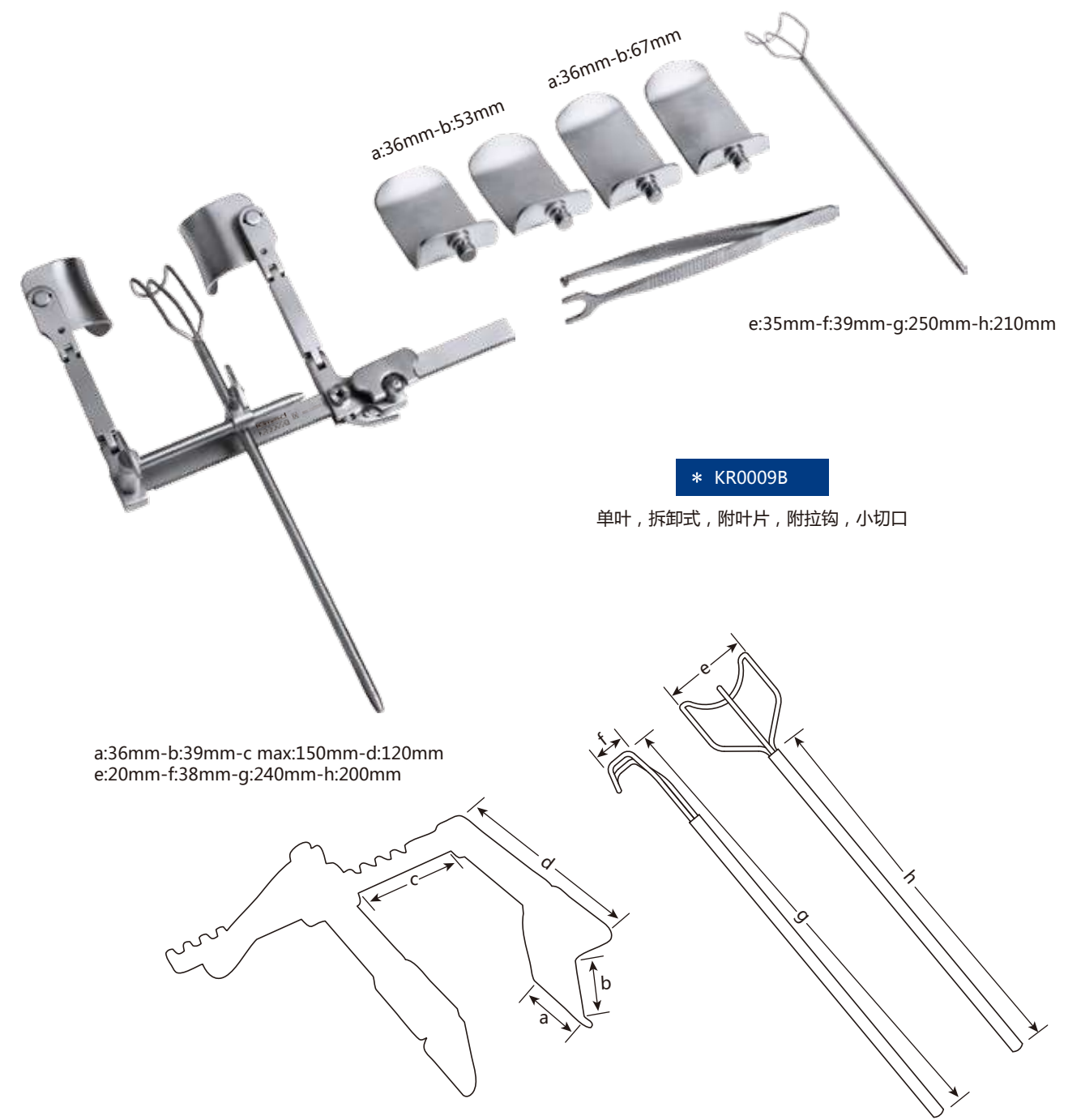
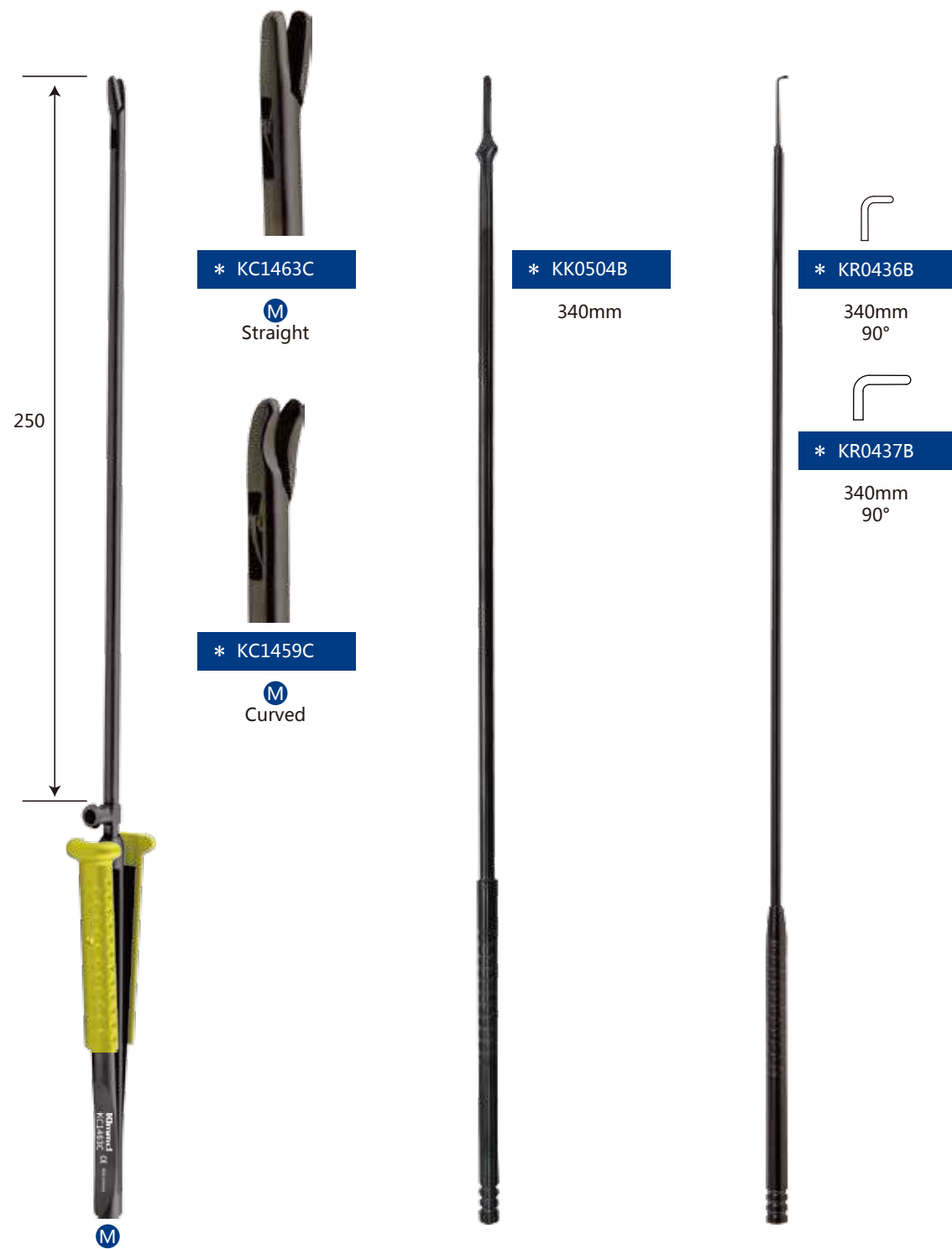



KR0015B

a:100mm-b:40mm-c max:165mm-d:200mm

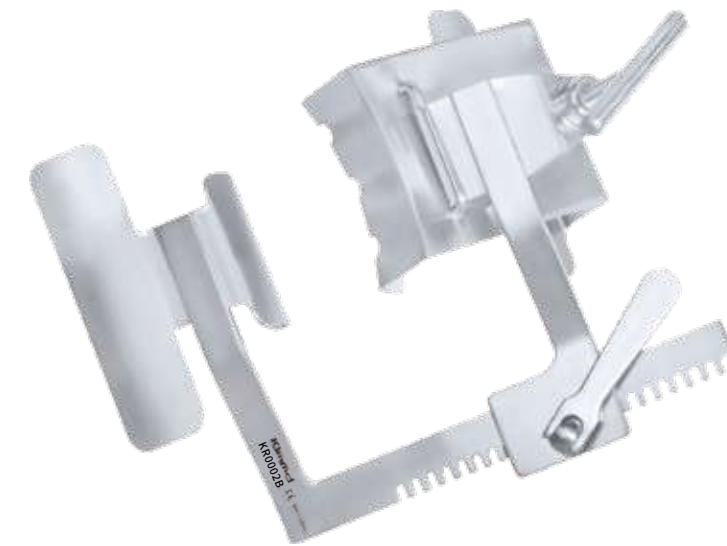
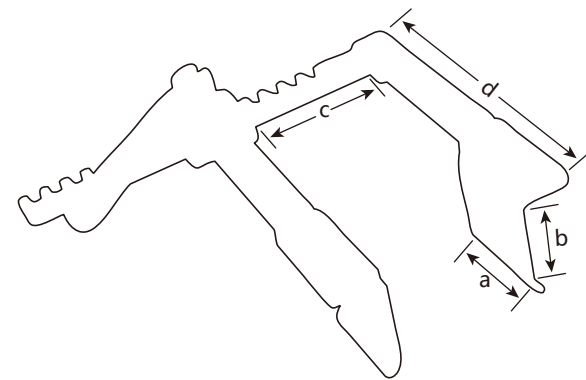

KR0002B

a:92mm-b:46mm-c max:140mm-d:222mm

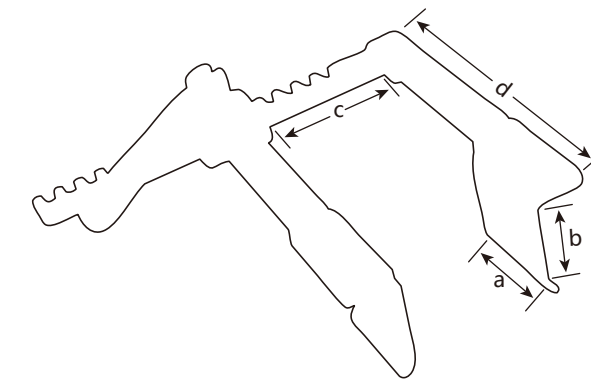

Selbsthaltender Retraktor  
Self Retaining Retractor

外科牵开器



**KR0079B**

a:20mm-b:36/32/28mm-c max:195mm-d:190mm

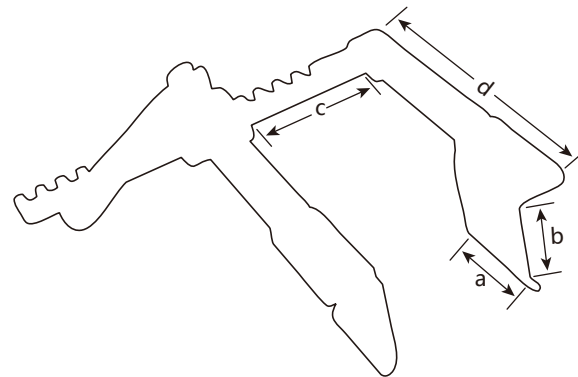

Selbsthaltender Retraktor  
Self Retaining Retractor

外科牵开器



**\* KR0097B**

a:100mm-b:36mm-c max:150mm-d:200mm-e:35mm-f:22mm-g:250mm-h:205mm

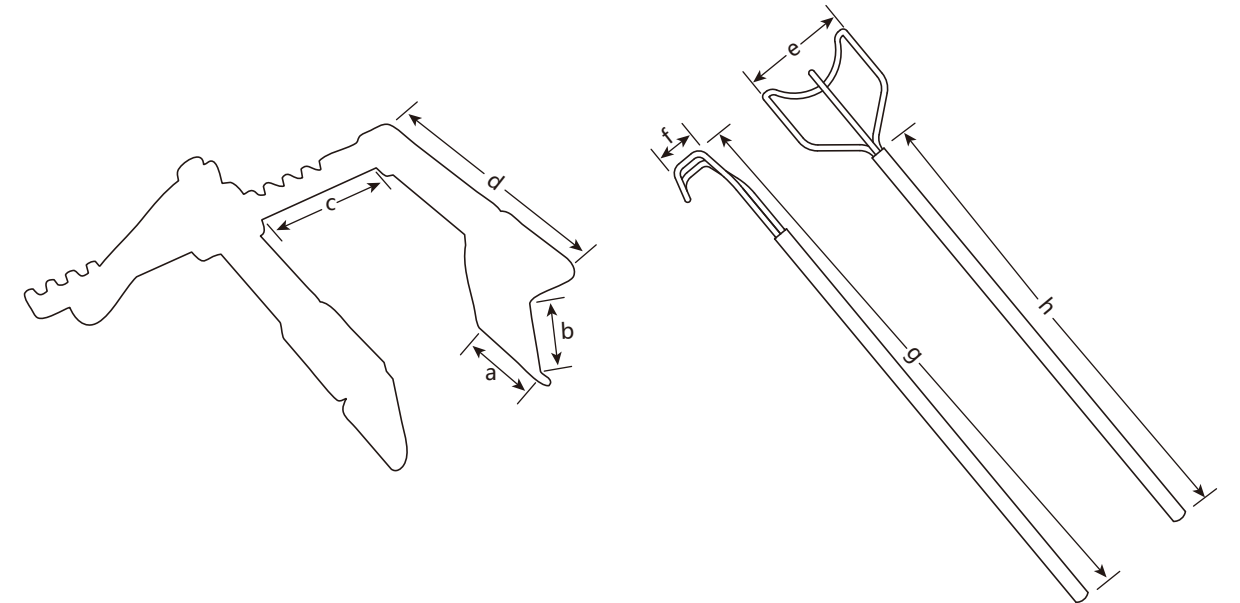



Selbsthaltender Retraktor  
Self Retaining Retractor

外科牵开器

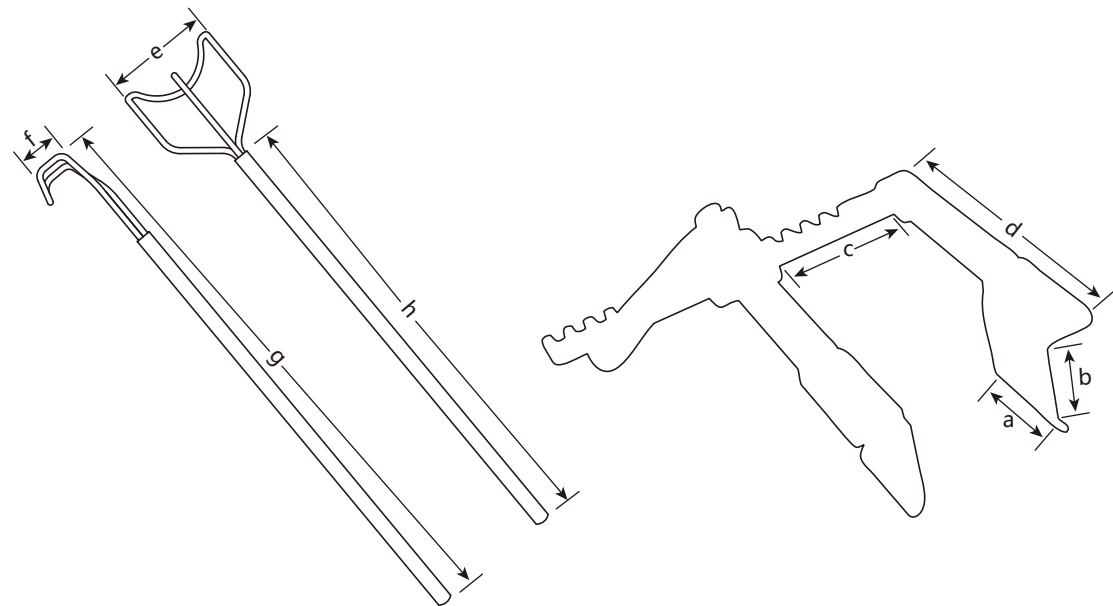
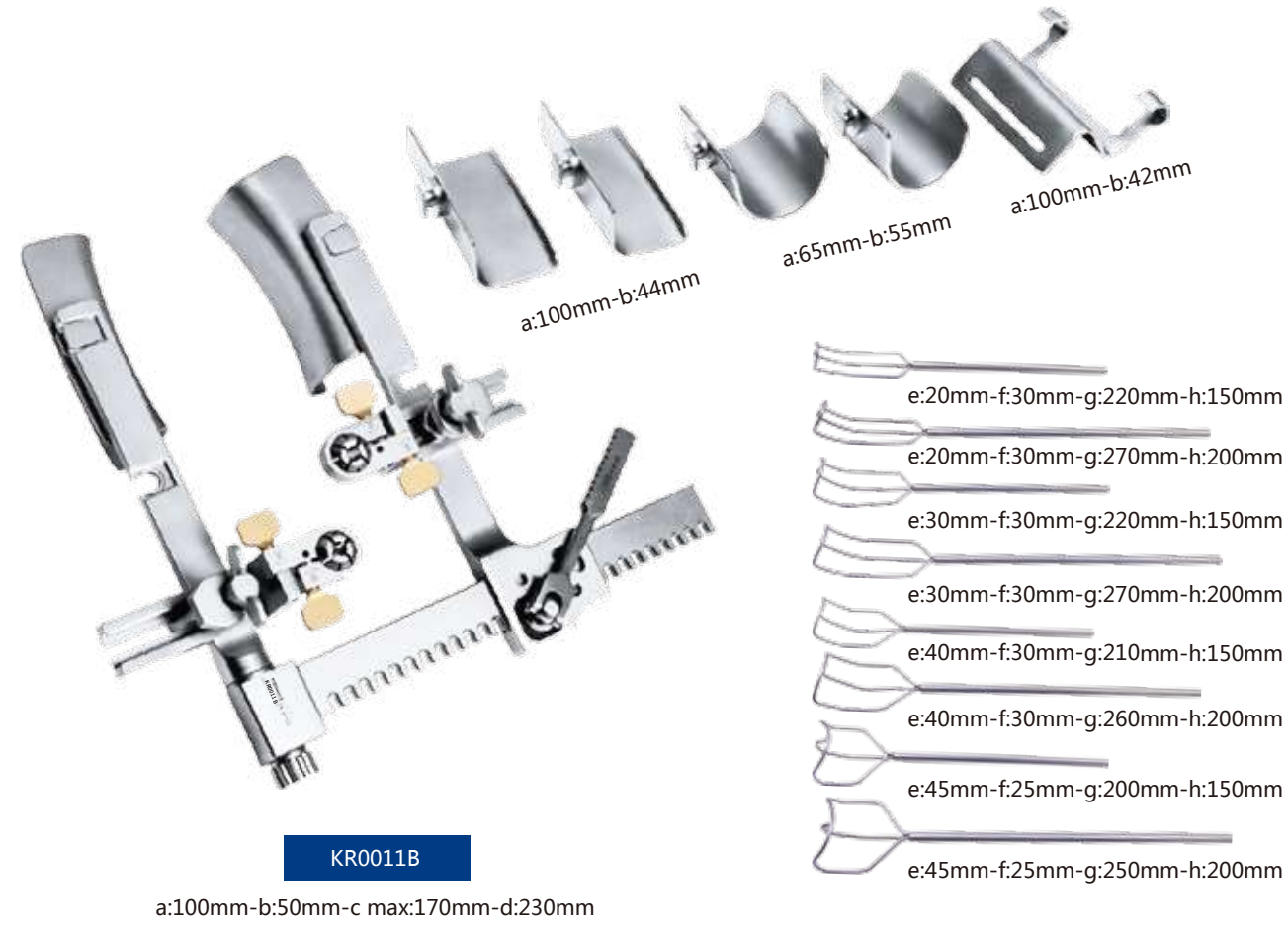

Selbsthaltender Retraktor  
Self Retaining Retractor

外科牵开器

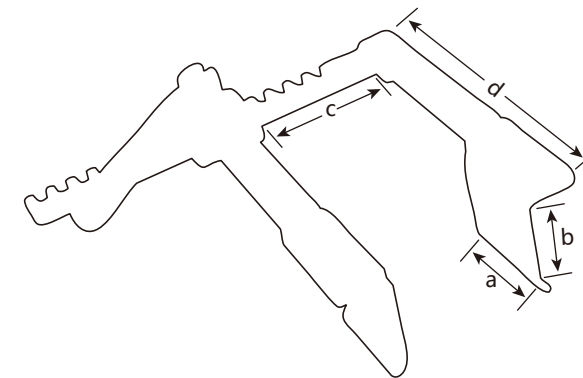
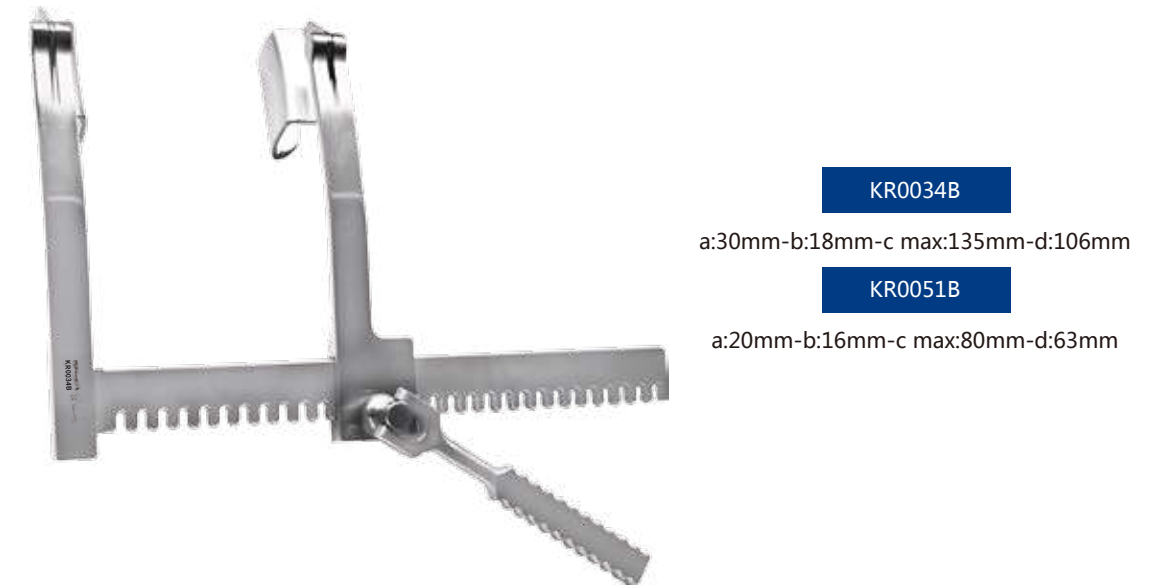



**KR0087B**

a:18mm-b:22mm-c max:125mm-d:150mm

**KR0069B**

a:30mm-b:24mm-c max:115mm-d:150mm

**KR0073B**

a:35mm-b:30mm-c max:180mm-d:205mm

**KR0068B**

a:37mm-b:30mm-c max:220mm-d:185mm

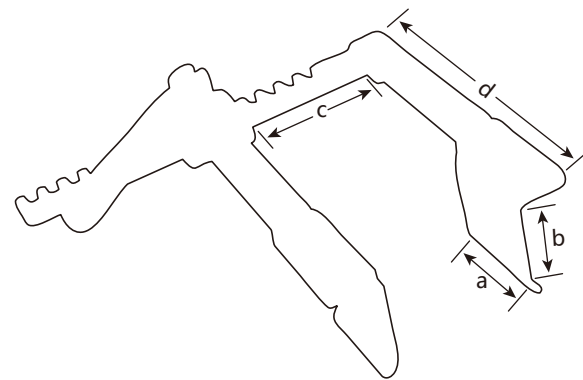

**KR0038B**

a:65mm-b:60mm-c max:200mm-d:200mm

**KR0095B**

a:60mm-b:52mm-c max:175mm-d:170mm

**KR0078B**

a:25mm-b:22mm-c max:90mm-d:105mm

**KR0042B**

a:18mm-b:18mm-c max:80mm-d:78mm

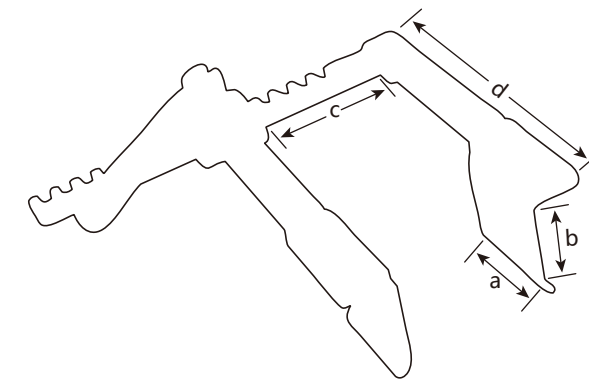

Selbsthaltender Retraktor  
Self Retaining Retractor

乳突牵开器



\* KR2397B

170, 活动式

Aorta Punch  
Aortic Punch

打孔器

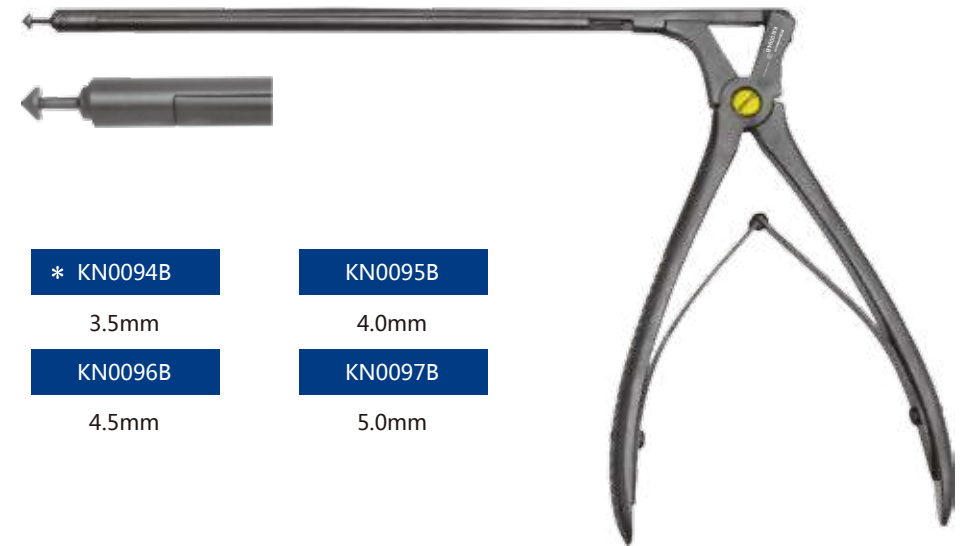

\* KN0094B

3.5mm

KN0096B

4.5mm

KN0095B

4.0mm

KN0097B

5.0mm



KN0079B

3.0mm

KN0082B

4.5mm

\* KN0080B

3.5mm

KN0083B

5.0mm

\* KN0081B

4.0mm



\* KR1234B

小切口



\* KR0816B

250



## MICRO LARYNGEAL INSTRUMENTS

### 喉显微手术器械

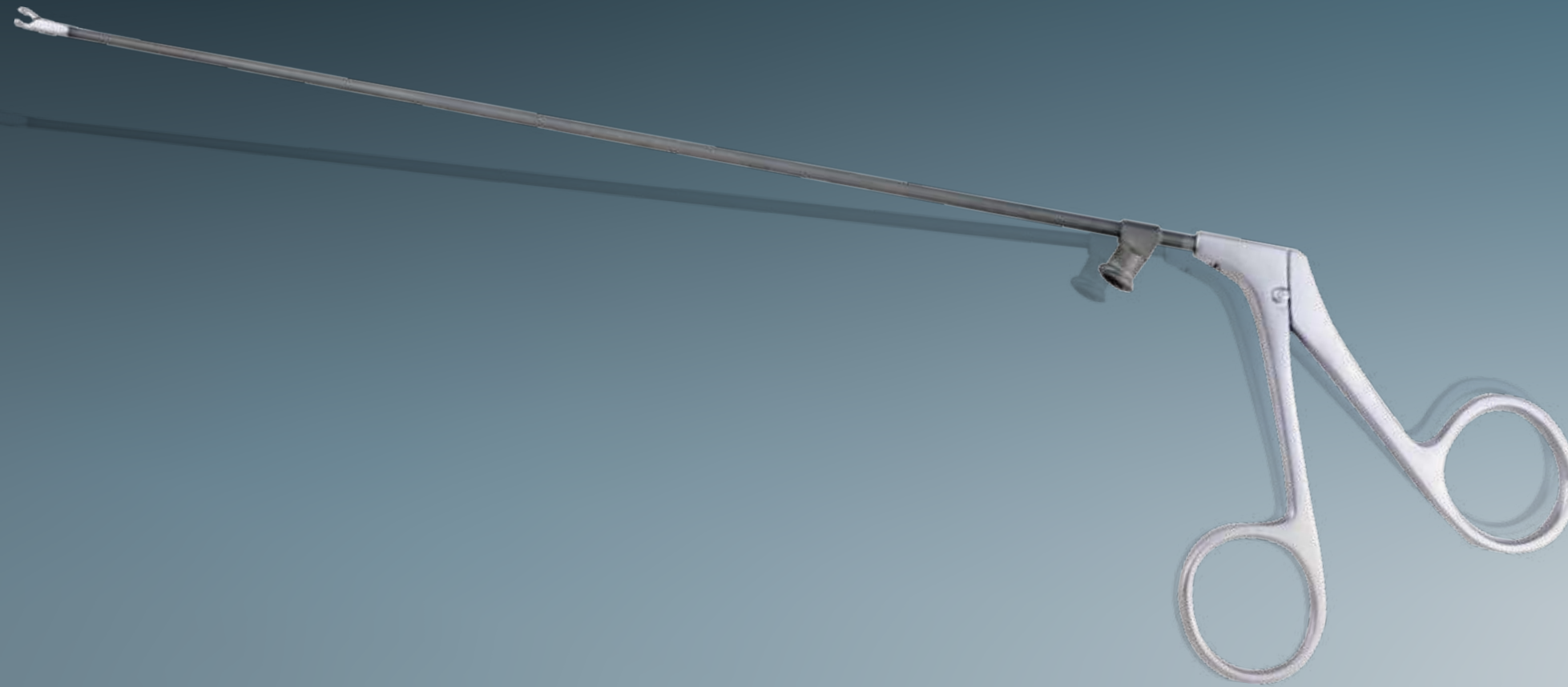

#### Fine working Jaws 精细工作头

A variety of specifications of the working head can fully adapt to different environment, to achieve intraoperative clamp, stripping, shearing and other operations, the shape of the working jaws, joints are smooth treatment, to avoid intraoperative scratches.

多种规格的工作头可充分适应不同的手术环境，实现术中钳取、剥离、剪切等操作，工作头外形、关节处均作光滑处理，避免术中划伤组织。



#### Luer Connector 鲁尔接口

The front of the handle is equipped with a flushing joint, which is convenient for cleaning and eliminating the internal cavity of the instrument, thus prolonging the service life and ensuring the quality of the instrument is always maintained at the first-class level.

手柄前方配有冲洗接头，便于器械管腔内部的清洁、消杀，从而延长使用寿命，保证器械品质始终维持一流水准。



#### Taper, coat working rod 锥度涂层工作杆

The rod part adopts taper tube design, fine size and reduce the shaking of the internal connecting rod, to maintain the stability of the working head, and on the surface of the frosting treatment, to avoid dazzling, dazzling.

杆部采用锥度管设计，精细尺寸并减小内部连杆晃动，保持工作头稳定，并在表面进行磨砂处理，避免术中炫光、刺眼。

Micro Larynx Schere  
Micro Laryngeal Scissors

显微喉剪



\* KM1088B

230mm  
Straight



\* KM1089B

230mm  
45°  
Upward



\* KM1090B

230mm  
15°  
Upward



\* KM1091B

230mm  
Right



\* KM1092B

230mm  
Left

Laryngealzange  
Laryngeal Forceps

喉钳



\* KC1721B

230mm  
Straight 2mm



\* KC1722B

230mm  
Upward 2mm



\* KC1723B

230mm  
Right 2mm



\* KC1724B

230mm  
Left 2mm



\* KC1725B

230mm  
Straight 1mm



\* KC1726B

230mm  
Right 1mm



\* KC1727B

230mm  
Left 1mm



\* KC1728B

230mm  
Upward 1mm



\* KC1729B

230mm  
Right 3mm



\* KC1730B

230mm  
Right 2mm



\* KC1731B

230mm  
Left 3mm



\* KC1732B

230mm  
Left 2mm



\* KC1750B

230mm  
Straight 2mm

Micro Haken/Micro Messer  
Micro Hooks/Micro Knife

显微钩/显微刀

Stripper/ Schnellkupplungsgriff  
Strippers/Quick Coupling Handle

剥离器/快装手柄

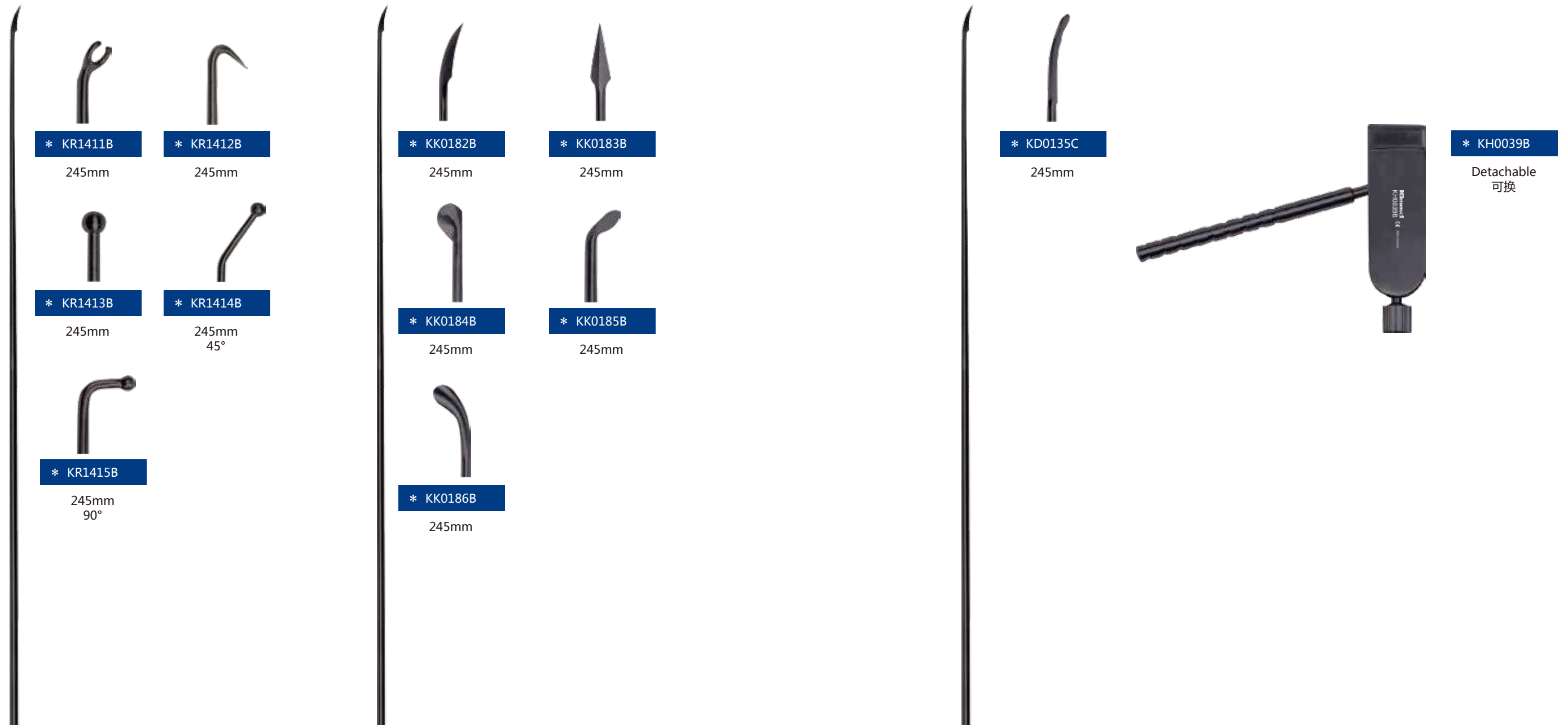

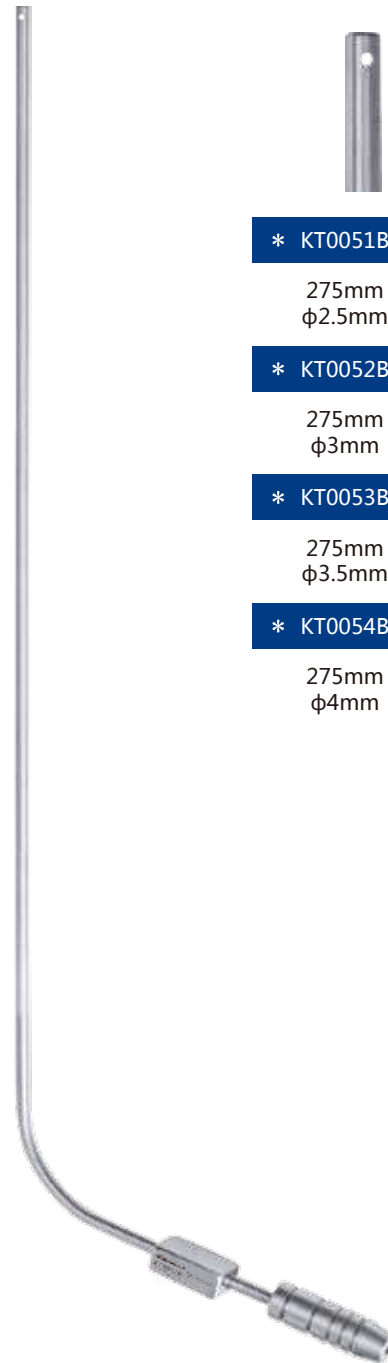

\* KT0051B

275mm  
φ2.5mm

\* KT0052B

275mm  
φ3mm

\* KT0053B

275mm  
φ3.5mm

\* KT0054B

275mm  
φ4mm

KU1000 颈动脉内膜剥脱手术器械

序号	编码	名称	规格	单位	数量
1	KS0073B	手术剪	180, 弯, 尖头, 镶片	把	1
2	KS0061B	手术剪	180, 弯, 宽头, 镶片	把	1
3	KS0113B	手术剪	180×45°	把	1
4	KS0105B	手术剪	180×60°	把	1
5	KB0016B	凹凸齿止血夹	110, 左弯, 反力式	把	1
6	KB0017B	凹凸齿止血夹	110, 右弯, 反力式	把	1
7	KP0954C	显微镊	180×0.3, 直, 金刚砂, 高尔夫, 涂层	把	1
8	KP1156C	显微镊	180×Φ1.0, 直, 金刚砂, 高尔夫, 涂层	把	1
9	KP1092C	显微镊	180×1.2, 直, DeBAKEY齿, 高尔夫, 涂层	把	1
10	KF0784C	显微持针钳	180×1.2, 直, 金刚砂, 高尔夫型, 自锁, 涂层	把	1
11	KM0366C	显微剪	180, 尖头, 刃长10, 弯, 高尔夫, 涂层	把	1
12	KC0043B	主动脉阻断钳	140, 弯	把	1
13	KC0031B	主动脉阻断钳	130, 弯	把	1
14	KD0000B	骨膜剥离器	180×1×2, 弯/弯, 双头	把	1
15	KD0001B	骨膜剥离器	180×3×4, 弯/弯, 双头	把	1
16	KC1525B	止血钳	130×13	把	1
17	KC1526B	止血钳	180×15	把	1

KU1002颅内搭桥器械（用于浅部手术）Nano涂层系列

序号	编码	名称	规格	单位	数量
1	KF0766C	显微持针钳	150×0.3, 直, 金刚砂, 高尔夫型, 自锁, 涂层	把	1
2	KF0767C	显微持针钳	150×0.3, 弯, 金刚砂, 高尔夫型, 自锁, 涂层	把	1
3	KP0941C	显微镊	150×0.3, 弯, 金刚砂, 高尔夫, 涂层	把	1
4	KP0940C	显微镊	150×0.3, 直, 金刚砂, 高尔夫, 涂层	把	1
5	KP1150C	显微镊	150×Φ1.0, 直, 金刚砂, 高尔夫, 涂层	把	1
6	KM0359C	显微剪	150, 尖头, 刃长10, 直, 高尔夫, 涂层	把	1
7	KM0360C	显微剪	150, 尖头, 刃长10, 弯, 高尔夫, 涂层	把	1

KU1003颅内搭桥器械（用于中部手术）钛合金系列

序号	编码	名称	规格	单位	数量
1	KF1812T	显微持针钳	180×0.3, 直, 金刚砂, 自锁, 钛合金	把	1
2	KF1813T	显微持针钳	180×0.3, 弯, 金刚砂, 自锁, 钛合金	把	1
3	KP1323T	显微镊	180×0.3, 弯, 金刚砂, 钛合金	把	1
4	KP1322T	显微镊	180×0.3, 直, 金刚砂, 钛合金	把	1
5	KP1534T	显微镊	180×Φ1, 直型, 环形, 镶金钢砂, 圆柄	把	1
6	KM0365C	显微剪	180, 尖头, 刃长10, 直, 高尔夫, 涂层	把	1
7	KM0366C	显微剪	180, 尖头, 刃长10, 弯, 高尔夫, 涂层	把	1

KU1004颅内搭桥器械（用于中部手术）Nano涂层系列

序号	编码	名称	规格	单位	数量
1	KF0780C	显微持针钳	180×0.8, 直, 金刚砂, 高尔夫型, 自锁, 涂层	把	1
2	KF0781C	显微持针钳	180×0.8, 弯, 金刚砂, 高尔夫型, 自锁, 涂层	把	1
3	KP0955C	显微镊	180×0.3, 弯, 金刚砂, 高尔夫, 涂层	把	1
4	KP0954C	显微镊	180×0.3, 直, 金刚砂, 高尔夫, 涂层	把	1
5	KP1156C	显微镊	180×Φ1.0, 直, 金刚砂, 高尔夫, 涂层	把	1
6	KM0365C	显微剪	180, 尖头, 刃长10, 直, 高尔夫, 涂层	把	1
7	KM0366C	显微剪	180, 尖头, 刃长10, 弯, 高尔夫, 涂层	把	1

KU1005颅内搭桥器械（用于深部手术）Sensation系列

序号	编码	名称	规格	单位	数量
1	KM0183B	显微剪	210, 尖头, 刃长10, 弯, peek柄, 枪状	把	1
2	KM0255B	显微剪	210, 圆头, 刃长10, 弯, peek柄, 枪状	把	1
3	KP1351T	显微镊	230×0.3, 弯, 金刚砂, 钛合金	把	1
4	KP1350T	显微镊	230×0.3, 直, 金刚砂, 钛合金	把	1
5	KP1546T	显微镊	230×Φ1, 直, 金刚砂, 钛合金	把	1
6	KF1493B	显微持针钳	210×0.3, 弯, 金刚砂, PEEK柄, 枪状	把	1



KU1006喉显微外科手术器械

序号	编码	名称	规格	单位	数量
1	KC1725B	喉钳	230×1, 管式, 直型, 麦粒形	把	1
2	KC1726B	喉钳	230×1, 管式, 右弯, 麦粒形	把	1
3	KC1727B	喉钳	230×1, 管式, 左弯, 麦粒形	把	1
4	KC1728B	喉钳	230×1, 管式, 上弯, 麦粒形	把	1
5	KC1721B	喉钳	230×Φ2, 管式, 直型, 圆头	把	1
6	KC1722B	喉钳	230×Φ2, 管式, 上弯, 圆头	把	1
7	KC1723B	喉钳	230×Φ2, 管式, 右弯, 圆头	把	1
8	KC1724B	喉钳	230×Φ2, 管式, 左弯, 圆头	把	1
9	KM1088B	显微喉剪	230, 管式, 直型, 涂层	把	1
10	KM1089B	显微喉剪	230×45°, 管式, 上弯, 涂层	把	1
11	KM1090B	显微喉剪	230×15°, 管式, 上弯, 涂层	把	1
12	KM1091B	显微喉剪	230, 管式, 右弯, 涂层	把	1
13	KM1092B	显微喉剪	230, 管式, 左弯, 涂层	把	1
14	KC1729B	喉钳	230×3, 管式, 角弯, 右弯, 抓取型	把	1
15	KC1731B	喉钳	230×3, 管式, 角弯, 左弯, 抓取型	把	1
16	KC1730B	喉钳	230×2, 管式, 角弯, 右弯, 抓取型	把	1
17	KC1732B	喉钳	230×2, 管式, 角弯, 左弯, 抓取型	把	1
18	KC1750B	喉钳	230×2, 管式, 直型, 有齿	把	1
19	KK0182B	显微刀	245, 直形, 镰刀	把	1
20	KK0183B	显微刀	245, 直形, 三角刃	把	1
21	KK0184B	显微刀	245, 直形, 圆刃	把	1
22	KK0185B	显微刀	245, 角弯, 圆刃	把	1
23	KK0186B	显微刀	245, 直形, 圆刃	把	1
24	KR1412B	显微钩	245, 圆弯	把	1
25	KD0200B	剥离器	245×1.5, 弯	把	1
26	KR1411B	显微钩	245	把	1
27	KR1413B	显微钩	245, 直型, 球头	把	1
28	KR1414B	显微钩	245, 角弯, 45°, 球头	把	1
29	KR1415B	显微钩	245, 角弯, 90°, 球头	把	1
30	KH0039B	快装手柄		把	1
31	KT0051B	吸引管	275×Φ2.5, 弯, 喉用, 可控	把	1
32	KT0052B	吸引管	275×Φ3, 弯, 喉用, 可控	把	1
33	KT0053B	吸引管	275×Φ3.5, 弯, 喉用, 可控	把	1
34	KT0054B	吸引管	275×Φ4, 弯, 喉用, 可控	把	1

KU1007胸腔外科手术器械

序号	编码	名称	规格	单位	数量
1	KC1463C	持针钳	280, 直头, 头宽3, 单开, 合金片, 握笔式, 涂层	把	1
2	KC1459C	持针钳	280, 弯头, 头宽3, 单开, 合金片, 握笔式, 涂层	把	1
3	KC0331C	夹持钳	250, 握笔管式, 涂层	把	1
4	KC0332C	夹持钳	250, 握笔管式, 涂层	把	1
5	KC0329C	夹持钳	250, 上翘45°, 单开, 握笔管式, 涂层	把	1
6	KC0323C	夹持钳	250×1.5, 1×2凹凸齿, 直头, 双开, 握笔管式, 涂层	把	1
7	KC0328C	夹持钳	250×1.5, 1×2凹凸齿, 角弯, 单开, 握笔管式, 涂层	把	1
8	KS0125C	手术剪	250, 弯45°, 单开, 握笔管式, 涂层	把	1
9	KS0127C	手术剪	250, 弯125°, 单开, 握笔管式, 涂层	把	1
10	KR0009B	外科牵开器	单叶, 拆卸式, 附叶片, 附拉钩, 小切口	把	1

KU1008冠状动脉旁路移植手术器械

序号	编码	名称	规格	单位	数量
1	KF0548B	显微持针钳	210×1.2, 直, 硬质合金, 自锁, 网花型	把	1
2	KF0564B	显微持针钳	230×1.2, 直, 硬质合金, 自锁, 网花型	把	1
3	KP1102C	显微镊	210×1.2, 直, DeBAKEY齿, 高尔夫, 涂层	把	1
4	KP1106C	显微镊	210×2.0, 直, DeBAKEY齿, 高尔夫, 涂层	把	1
5	KP1107C	显微镊	210×2.0, 弯, DeBAKEY齿, 高尔夫, 涂层	把	1
6	KP2527B	胸腔镊	195×1.5, DeBAKEY齿, 硬质合金	把	1
7	KP1162C	显微镊	210×Φ1.0, 直, 金刚砂, 高尔夫, 涂层	把	1
8	KP0972C	显微镊	210×0.7, 直, 金刚砂, 高尔夫, 涂层	把	1
9	KM1006C	显微剪	180, 尖头, 刃长10, 45°, 高尔夫柄, 涂层	把	1
10	KM1012C	显微剪	180, 尖头, 刃长10, 90°, 高尔夫柄, 涂层	把	1
11	KM1015C	显微剪	180, 尖头, 刃长10, 125°, 高尔夫柄, 涂层	把	1
12	KN0016B	探针	180×1.0, 记忆合金, 血管	把	1
13	KN0018B	探针	180×1.5, 记忆合金, 血管	把	1
14	KN0020B	探针	180×2.0, 记忆合金, 血管	把	1
15	KC0287B	血管钳	200×40, 双角弯, DeBAKEY齿	把	1
16	KC0288B	血管钳	200×47, 双角弯, DeBAKEY齿	把	1

序号	编码	名称	规格	单位	数量
17	KB0000B	止血夹	55, 直头, 横齿, 反力式	把	1
18	KB0001B	止血夹	55, 弯头, 横齿, 反力式	把	1
19	KB0002B	止血夹	60, 直头, 横齿, 反力式	把	1
20	KB0003B	止血夹	60, 弯头, 横齿, 反力式	把	1
21	KC1490B	钛夹钳	200, 小号, 角弯20°	把	1
22	KC1492B	钛夹钳	200, 中号, 角弯20°	把	1
23	KT0482B	显微冲洗针	60×3	把	1
24	KT0481B	显微冲洗针	60×2	把	1
25	KR0000C	外科牵开器	28, 血管	把	1
26	KR0001C	外科牵开器	38, 血管	把	1
27	KC0004B	持针钳	200, 直头, 镶片	把	1
28	KS0073B	手术剪	180, 弯, 尖头, 带齿, 镶片	把	1
29	KN0022B	探针	180×2.5, 记忆合金, 血管	把	1
30	KC0290B	血管钳	215×72×90°, 弯, DeBAKEY齿	把	1
31	KC0292B	血管钳	270×108×92°, 弯, DeBAKEY齿	把	1
32	KC0289B	血管钳	260×65×60°, 弯, DeBAKEY齿	把	1
33	KK0502B	手术刀柄	155, 直型	把	1
34	KC1525B	分离结扎钳	130×13×105°, 角弯, 全齿	把	1
35	KC1553B	分离结扎钳	160×13×105°, 角弯, 全齿	把	1
36	KT0000B	吸引管	280	把	1
37	KR0416B	显微钩	210×Φ1×90°	把	1

KU1009瓣膜置换手术器械

序号	编码	名称	规格	单位	数量
1	KS0119B	手术剪	245, 瓣膜	把	1
2	KC0337B	夹持钳	220	把	1
3	KP2530B	胸腔镊	195×2, DeBAKEY齿, 硬质合金	把	1
4	KP1102C	显微镊	210×1.2, 直, DeBAKEY齿, 高尔夫, 涂层	把	1
5	KC0132B	血管钳	240×40, 双弯, DeBAKEY齿, 弯柄	把	1
6	KC0395B	持针钳	230, 双弯, 头宽2, 合金片	把	1
7	KD0136C	剥离器	240×1.5/3, 双头	把	1
8	KD0134C	剥离器	240×2/4, 双头	把	1
9	KR0590B	拉钩	240×9.5×4	把	1
10	KR0591B	拉钩	240×9.5×8	把	1
11	KP2572B	胸腔镊	205, 熊掌	把	1
12	KP2573B	胸腔镊	255, 熊掌	把	1
13	KC0494B	髓核钳	260×5, 直, 指圈式	把	1
14	KP2631B	胸腔镊	230×2, 直, 瓣膜	把	1
15	KM1006C	显微剪	180, 尖头, 刃长10, 45°, 高尔夫柄, 涂层	把	1
16	KC0292B	血管钳	270×108×92°, 弯, DeBAKEY齿	把	1
17	KR0000C	外科牵开器	28, 血管	把	1
18	KR0001C	外科牵开器	38, 血管	把	1
19	KB0015B	止血夹	55, 弯头, 1×2凹凸齿, 可调式	把	1
20	KM0365C	显微剪	180, 尖头, 刃长10, 直, 高尔夫, 涂层	把	1
21	KF0532B	显微持针钳	180×1.2, 直, 硬质合金, 自锁, 网花型	把	1
22	KC0291B	血管钳	230×45×90°, 弯, DeBAKEY齿	把	1
23	KC1527B	分离结扎钳	200×13×105°, 角弯, 全齿	把	1
24	KC1528B	分离结扎钳	230×13×105°, 角弯, 全齿	把	1
25	KF0548B	显微持针钳	210×1.2, 直, 硬质合金, 自锁, 网花型	把	1

瓣膜置换手术器械

序号	编码	名称	规格	单位	数量
1	KP2599B	胸腔镊	总长210MM, 直头, 头宽2.0MM, 无损伤DeBakey齿	把	1
2	KP2507B	胸腔镊	总长240MM, 直头, 头宽2.0MM, 无损伤DeBakey齿	把	1
3	KP2527B	胸腔镊	总长195MM, 直头, 头宽1.5MM, 镶合金片TC, 无损伤DeBakey齿	把	1
4	KP2530B	胸腔镊	总长195MM, 直头, 头宽2.0MM, 镶合金片TC, 无损伤DeBakey齿	把	1
5	KP2631B	胸腔镊	总长230MM, 直头, 头宽2.0MM, 无损伤Resano齿	把	1
6	KP2572B	胸腔镊	总长200MM, 直头, 头宽8.0MM, Durand齿	把	1
7	KC0289B	血管钳	总长260MM, 弯头, 角度60°, 头宽65MM, 无损伤DeBakey齿, S型钳身环形手柄	把	1
8	KC0132B	血管钳	总长240MM, 弯头, 头宽40MM, 无损伤DeBakey齿, S型钳身环形手柄	把	1
9	KC0428B	持针钳	总长250MM, 直头, 适用于up to 3/0, 镶合金片TC, 齿距0.5MM, 直型钳身环形手柄	把	1
10	KC0436B	持针钳	总长220MM, 直头, 适用于4/0- 6/0, 镶合金片TC, 齿距0.4MM, 直型钳身环形手柄	把	1
11	KC0435B	持针钳	总长200MM, 直头, 适用于4/0- 6/0, 镶合金片TC, 齿距0.4MM, 直型钳身环形手柄	把	1
12	KC0395B	持针钳	总长230MM, 弯头, 适用于1/0- 4/0, 镶合金片TC, S型钳身环形手柄	把	1
13	KF0502B	显微持针钳	总长250MM, 直头, 头宽2.0MM, 适用于1/0- 4/0, 镶金钢砂Diamonded, 网状滚花自锁手柄	把	1
14	KF0486B	显微持针钳	总长230MM, 直头, 头宽2.0MM, 适用于1/0- 4/0, 镶金钢砂Diamonded, 网状滚花自锁手柄	把	1
15	KC0004B	钢丝结扎钳	总长200MM, 直头, 镶合金片TC, 直型钳身环形手柄	把	1
16	KS0066B	手术剪	总长230MM, Metzenbaum超锋利精细型剪刀, 弯头, 前端为宽头, 镶合金片TC	把	1
17	KS0063B	手术剪	总长200MM, Metzenbaum超锋利精细型剪刀, 弯头, 前端为宽头, 镶合金片TC	把	1
18	KS0119B	手术剪	总长245MM, 弯头, Thorek剪, 前端为宽头, S型钳身环形手柄	把	1
19	KR0590B	剥离器	总长240MM, 深度9.5MM, 宽度4MM, 圆形滚花手柄	把	1
20	KR0591B	剥离器	总长240MM, 深度9.5MM, 宽度8MM, 圆形滚花手柄	把	1
21	KD0136C	剥离器	总长240MM, 双头, 一端头宽1.5MM, 一端头宽3MM, 圆形滚花手柄	把	1
22	KR0416B	显微钩	总长210MM, 直径1.0MM, 角度90°	把	1
23	KC0337B	夹持钳	总长220MM, 弯头Allis钳, 头宽7.5MM, 环形手柄	把	1
<b>选配件</b>					
1	KR0097B	外科牵开器	最大牵开距离195MM, 臂长190MM, 瓣叶片宽度100MM, 深度36MM。带有三个规格的拉钩, 总体长度均为180MM, 其余尺寸分别为宽度20MM, 长度60MM; 宽度35MM, 长度60MM; 宽度45MM, 长度60MM。	1	套
2	KR0014B	外科牵开器	最大牵开距离190MM, 臂长240MM。带有两种规格瓣叶片分别为宽度100MM, 深度34MM; 宽度28MM, 深度37MM。	1	套

大血管手术器械

序号	编码	名称	规格	单位	数量
1	KP2502B	胸腔镊	总长240MM, 直头, 头宽1.5MM, 无损伤DeBakey齿	把	1
2	KP2507B	胸腔镊	总长240MM, 直头, 头宽2.0MM, 无损伤DeBakey齿	把	1
3	KP2527B	胸腔镊	总长195MM, 直头, 头宽1.5MM, 镶合金片TC, 无损伤DeBakey齿	把	1
4	KP1102C	显微镊	总长210MM, 直头, 头宽1.2MM, 无损伤DeBakey齿	把	1
5	KR0416B	显微钩	总长210MM, 直径1.0MM, 角度90°	把	1
6	KF0564B	显微持针钳	总长230MM, 直头, 头宽1.2MM, 适用于4/0, 镶合金片TC, 网状滚花自锁手柄	把	1
7	KF0502B	显微持针钳	总长250MM, 直头, 头宽2.0MM, 适用于5/0-8/0, 镶金钢砂Diamonded, 网状滚花自锁手柄	把	1
8	KF0800C	显微持针钳	总长210MM, 直头, 头宽1.2MM, 适用于4/0, 镶金钢砂Diamonded, Golf防滑手柄	把	1
9	KC0428B	持针钳	总长250MM, 直头, 适用于up to 3/0, 镶合金片TC, 齿距0.5MM	把	1
10	KC0436B	持针钳	总长220MM, 直头, 适用于4/0- 6/0, 镶合金片TC, 齿距0.4MM	把	1
11	KC0435B	持针钳	总长200MM, 直头, 适用于4/0- 6/0, 镶合金片TC, 齿距0.4MM	把	1
12	KC0453B	持针钳	总长200MM, 直头, 适用于6/0- 10/0, 镶合金片TC, 齿距0.2MM	把	1
13	KC0395B	持针钳	总长230MM, 弯头, 适用于1/0- 4/0, 镶合金片TC, S型钳身环形手柄	把	1
14	KS0073B	手术剪	总长180MM, Metzenbaum超锋利精细型剪刀, 弯头, 前端为尖头, 镶合金片TC	把	1
15	KS0063B	手术剪	总长200MM, Metzenbaum超锋利精细型剪刀, 弯头, 前端为宽头, 镶合金片TC	把	1
16	KS0066B	手术剪	总长230MM, Metzenbaum超锋利精细型剪刀, 弯头, 前端为宽头, 镶合金片TC	把	1
17	KC1526B	分离结扎钳	总长180MM, Diethrich齿, 角度105°, 头宽13MM, 直型钳身环形手柄	把	1
18	KC1527B	分离结扎钳	总长200MM, Diethrich齿, 角度105°, 头宽13MM, 直型钳身环形手柄	把	1
19	KC0111B	血管钳	总长265MM, 无损伤DeBakey2×3齿, 弯头, C型钳身环形手柄	把	1
20	KC0108B	血管钳	总长320MM, 无损伤DeBakey2×3齿, 弯头, C型钳身环形手柄	把	1
21	KC0311B	血管钳	总长160MM, 无损伤DeBakey齿, 角度30°, 头宽19MM, S型钳身环形手柄	把	1
22	KC0312B	血管钳	总长160MM, 无损伤DeBakey齿, 角度60°, 头宽32MM, S型钳身环形手柄	把	1
23	KC0050B	血管钳	总长190MM, 无损伤DeBakey齿, 角度15°, 直型钳身环形手柄	把	1
24	KC0049B	血管钳	总长190MM, 无损伤DeBakey齿, 角度30°, 直型钳身环形手柄	把	1
25	KC0021B	血管钳	总长180MM, 无损伤DeBakey齿, 角度45°, 直型钳身环形手柄	把	1
26	KC0104B	血管钳	总长180MM, 无损伤DeBakey齿, 角度60°, S型钳身环形手柄	把	1
27	KC0064B	血管钳	总长305MM, 无损伤DeBakey齿, 角度60°, 头宽65MM, S型钳身环形手柄	把	1
28	KC0058B	血管钳	总长250MM, 无损伤DeBakey齿, 弯头, 直型钳身环形手柄	把	1
29	KC0120B	血管钳	总长255MM, 无损伤DeBakey齿, 双弯, 头宽40MM, S型钳身环形手柄	把	1
30	KC0128B	血管钳	总长275MM, 无损伤DeBakey齿, 双弯, 头宽54MM, S型钳身环形手柄	把	1
31	KC0289B	血管钳	总长260MM, 无损伤DeBakey齿, 角度60°, 头宽65MM, S型钳身环形手柄	把	1
32	KR2397B	乳突牵开器	总长170MM, 头部3×3钝钩, 钩深21mm, 可调节式头部	把	1



冠状动脉旁路移植手术器械

序号	编码	名称	规格	单位	数量
1	KK0500B	手术刀柄	总长150MM, 直型, 六方手柄	把	1
2	KS0061B	精细剪	总长180MM, Metzenbaum超锋利精细型剪刀, 弯头, 前端为宽头, 镶合金片TC	把	1
3	KM1006C	冠状动脉剪	总长180MM, 45°角度, 刃长10MM, Golf防滑手柄	把	1
4	KM1012C	冠状动脉剪	总长180MM, 90°角度, 刃长10MM, Golf防滑手柄	把	1
5	KM1015C	冠状动脉剪	总长180MM, 125°角度, 刃长10MM, Golf防滑手柄	把	1
6	KF0796C	显微持针钳	总长210MM, 直头, 头宽0.8MM, 适用于7/0-8/0, 镶金钢砂Diamonded, Golf防滑手柄	把	1
7	KF0798C	显微持针钳	总长210MM, 直头, 头宽1.0MM, 适用于5/0-6/0, 镶金钢砂Diamonded, Golf防滑手柄	把	1
8	KF0800C	显微持针钳	总长210MM, 直头, 头宽1.2MM, 适用于4/0, 镶金钢砂Diamonded, Golf防滑手柄	把	1
9	KN0016B	探针	总长180MM, 直径1.0MM, 记忆合金材质	把	1
10	KN0018B	探针	总长180MM, 直径1.5MM, 记忆合金材质	把	1
11	KN0020B	探针	总长180MM, 直径2.0MM, 记忆合金材质	把	1
12	KP2583B	胸腔镊	总长210MM, 弯头, 头宽2.0MM, 无损伤DeBakey齿	把	1
13	KP2628B	胸腔镊	总长210MM, 直头, 头宽1.2MM, 无损伤DeBakey齿	把	1
14	KP2599B	胸腔镊	总长210MM, 直头, 头宽2.0MM, 无损伤DeBakey齿	把	1
15	KP2527B	胸腔镊	总长195MM, 直头, 头宽1.5MM, 镶合金片TC, 无损伤DeBakey齿	把	1
16	KP2530B	胸腔镊	总长195MM, 直头, 头宽2.0MM, 镶合金片TC, 无损伤DeBakey齿	把	1
17	KP1162C	显微镊	总长210MM, 直径1.0MM, 环形, 镶金钢砂Diamonded, Golf防滑手柄	把	1
18	KP0970C	显微镊	总长210MM, 直头, 头宽0.5MM, 镶金钢砂Diamonded, Golf防滑手柄	把	1
19	KB0000B	显微止血夹	总长55MM, 直型, Diethrich齿, 压力值120g	把	1
20	KB0001B	显微止血夹	总长55MM, 弯型, Diethrich齿, 压力值120g	把	1
21	KB0011B	显微止血夹	总长55MM, 直型, 无损伤DeBakey齿, 压力值120g	把	1
22	KB0012B	显微止血夹	总长55MM, 弯型, 无损伤DeBakey齿, 压力值120g	把	1
23	KR0000C	外科牵开器	总长28MM, 头部3×3齿, 镀金表面	把	1
27	KR0001C	外科牵开器	总长38MM, 头部3×3齿, 镀金表面	把	1
28	KT0481B	显微平头冲洗针	总长60MM, 头部直径2.0MM, 直头	把	1
29	KT0482B	显微平头冲洗针	总长60MM, 头部直径3.0MM, 直头	把	1
30	KC1490B	钛夹钳	总长200MM, 用于Small钛夹, 指圈式, 柄部黄色 (适用于泰利福款)	把	1
31	KC1492B	钛夹钳	总长200MM, 用于Medium钛夹, 指圈式, 柄部黄色 (适用于泰利福款)	把	1
32	KC1491B	钛夹钳	总长200MM, 用于Small-Wide钛夹, 指圈式, 柄部红色 (适用于泰利福款)	把	1
33	KC0287B	主动脉侧壁钳	总长200MM, 无损伤DeBakey齿, 40MM宽, S型钳身环形手柄	把	1
34	KC0288B	主动脉侧壁钳	总长200MM, 无损伤DeBakey齿, 50MM宽, S型钳身环形手柄	把	1
35	KN0080B	打孔器	总长140MM, 头部直径3.5MM	把	1
36	KN0081B	打孔器	总长140MM, 头部直径4.0MM	把	1

选配件

1	KR0015B	胸骨牵开器 选配件	最大牵开距离165MM, 可拆卸。有三种规格瓣叶片分别为宽度120MM, 深度32MM; 宽度100MM, 深度32MM; 宽度60MM, 深度24MM。	套	1
2	KR0079B	乳内牵开器 选配件	最大牵开距离195MM, 臂长190MM, 大瓣叶片宽度100MM, 深度24MM。小瓣叶片有三种规格宽度均为20MM, 深度分别为36MM、32MM、28MM。	套	1
3	KR0002B	外科牵开器	最大牵开距离140MM, 臂长222MM, 瓣叶片宽度92MM, 深度46MM。	套	1

微创瓣膜置换手术器械

序号	编码	名称	规格	单位	数量
1	KS0123C	手术剪	总长340MM, 弯头, 30°弧头, 握笔管式手柄	把	1
2	KS0124C	手术剪	总长340MM, 弯头, 70°弧头, 握笔管式手柄	把	1
3	KC1459C	持针钳	总长340MM, 弯头, 镶合金片TC, 握笔管式手柄	把	1
4	KC1463C	持针钳	总长340MM, 直头, 镶合金片TC, 握笔管式手柄	把	1
5	KC0325C	夹持钳	总长340MM, 直头, 头宽2.8MM, 无损伤DeBakey齿, 握笔管式手柄	把	1
6	KC0327C	夹持钳	总长340MM, 直头, 头宽3MM, 无损伤DeBakey齿, 握笔管式手柄	把	1
7	KC0329C	夹持钳	总长340MM, 上弯, 45°, 握笔管式手柄	把	1
8	KR0436B	显微钩	总长340MM, 90°弯, 头端长5MM, 滚花直型手柄	把	1
9	KR0437B	显微钩	总长340MM, 90°弯, 头端长9MM, 滚花直型手柄	把	1
10	KK0504B	手术刀柄	总长340MM, 直型, 滚花直型手柄	把	1
11	KC0498B	髓核钳	总长300MM, 直型, 头宽3MM, 枪状指圈式手柄	把	1
12	KC3400B	血管钳	总长460MM, 弯型, 链式, DeBakey齿, 枪状手柄	把	1
13	KC3403B	夹持钳	总长360MM, 直型, 指圈式手柄	把	1

选配件

1	KR0009B	外科牵开器	最大牵开距离150MM, 可拆卸。有1个叶片拆卸镊, 3对叶片, 1个拉钩。叶片尺寸有2种规格, 宽度均为36MM, 深度分别为53MM、67MM。拉钩尺寸为宽度35MM, 深度39MM, 总长250MM。	套	1
2	KR0816B	外科牵开器	整套器械包含1个万向调节模块, 1个操作杆, 1个扳手, 1个安装钳, 2个折叠款叶片, 3个常规款叶片, 3个侧翼款叶片。2个折叠款叶片宽度均为10MM, 长度分别为35MM、44MM。3个常规款叶片和3个侧翼款叶片尺寸一致, 分别为宽度30MM, 长度31MM; 宽度34MM, 长度40MM; 宽度34MM, 50MM。	套	1

微创冠状动脉旁路移植器械

序号	编码	名称	规格	单位	数量
1	KC0323C	夹持钳	总长340MM, 直头, 头宽1.5MM, 无损伤DeBakey齿, 握笔管式手柄	把	1
2	KC0331C	夹持钳	总长340MM, MINI, 握笔管式手柄	把	1
3	KC0332C	夹持钳	总长340MM, Standard, 握笔管式手柄	把	1
4	KC0329C	夹持钳	总长340MM, 上弯, 45°, 握笔管式手柄	把	1
5	KS0123C	手术剪	总长340MM, 弯头, 30°弧头, 握笔管式手柄	把	1
6	KS0125C	手术剪	总长340MM, 角弯, 45°, 握笔管式手柄	把	1
7	KS0127C	手术剪	总长340MM, 角弯, 125°, 握笔管式手柄	把	1
8	KC1459C	持针钳	总长340MM, 弯头, 镶合金片TC, 握笔管式手柄	把	1
9	KC1463C	持针钳	总长340MM, 直头, 镶合金片TC, 握笔管式手柄	把	1
10	KR0436B	显微钩	总长340MM, 90°弯, 头端长5MM, 滚花直型手柄	把	1
11	KR0437B	显微钩	总长340MM, 90°弯, 头端长9MM, 滚花直型手柄	把	1
12	KN0016B	探针	总长180MM, 杆部直径1MM, 记忆合金	把	1
13	KN0018B	探针	总长180MM, 杆部直径1.5MM, 记忆合金	把	1
14	KN0020B	探针	总长180MM, 杆部直径2MM, 记忆合金	把	1
15	KN0022B	探针	总长180MM, 杆部直径2.5MM, 记忆合金	把	1
16	KK0504B	手术刀柄	总长340MM, 直型, 滚花直型手柄	把	1
17	KN0094B	打孔器	总长180MM, 头部直径3.5MM, 枪状手柄	把	1

选配件

KR0016B	外科牵开器	最大牵开距离145MM, 可拆卸。有3对I型的叶片, 3对II型的叶片, 1个叶片拆装钳, 1个调整扳手。叶片尺寸有3种规格, 宽度均为35MM, 深度分别为40MM、50MM、60MM。	套	1
KR0020B	外科牵开器	整套器械包含1个支架, 2个中转组件, 1个床夹组件, 2个螺杆组件, 5个叶片, 1个叶片拆卸镊。叶片尺寸有5种规格, 分别为宽度30MM, 深度110MM; 宽度30MM, 深度90MM; 宽度30MM, 深度70MM; 宽度20MM, 深度60MM; 宽度20MM, 深度45MM。	套	1
KR0019B	外科牵开器	最大牵开距离76MM, 可拆卸。有3对I型的叶片, 3对II型的叶片, 1个叶片拆装钳, 1个调整扳手。叶片尺寸有3种规格, 宽度均为35MM, 深度分别为40MM、50MM、60MM。	套	1

颈动脉内膜剥脱手术器械

序号	编码	名称	规格	单位	数量
1	KS0073B	手术剪	180, 弯, 尖头, 带齿, 镶片	把	1
2	KS0061B	手术剪	180, 弯, 钝头, 带齿, 镶片	把	1
3	KS0113B	手术剪	180×45°, 带齿, 镶片	把	1
4	KS0105B	手术剪	180×60°, 带齿, 镶片	把	1
5	KB0016B	止血夹	110, 左弯, 1×2凹凸齿, 反力式	把	1
6	KB0017B	止血夹	110, 右弯, 1×2凹凸齿, 反力式	把	1
7	KP0954C	显微镊	180×0.3, 直, 金刚砂, 高尔夫, 涂层	把	1
8	KP1156C	显微镊	180×Φ1.0, 直, 金刚砂, 高尔夫, 涂层	把	1
9	KP1092C	显微镊	180×1.2, 直, DeBAKEY齿, 高尔夫, 涂层	把	1
10	KF0784C	显微持针钳	180×1.2, 直, 金刚砂, 高尔夫型, 自锁, 涂层	把	1
11	KM0366C	显微剪	180, 尖头, 刃长10, 弯, 高尔夫, 涂层	把	1
12	KC0043B	血管钳	150×18, 双弯, DeBAKEY齿, 弯柄	把	1
13	KC0031B	血管钳	130, 角弯45°, DeBAKEY齿, 直柄	把	1
14	KD0000B	骨膜剥离器	180×1×2, 双头, 弯	把	1
15	KD0001B	骨膜剥离器	180×3×4, 双头, 弯	把	1
16	KC1525B	分离结扎钳	130×13×105°, 角弯, 全齿	把	1
17	KC1526B	分离结扎钳	180×13×105°, 角弯, 全齿	把	1

选配件

1	KR2397B	乳突牵开器	170, 活动式	把	1
2	KC0361B	夹持钳	160	把	1
3	KC0362B	夹持钳	190	把	1
4	KC0303B	血管钳	130, 左弯, COOLEY齿	把	1
5	KC0304B	血管钳	130, 右弯, COOLEY齿	把	1