

口腔科
Oral Instruments

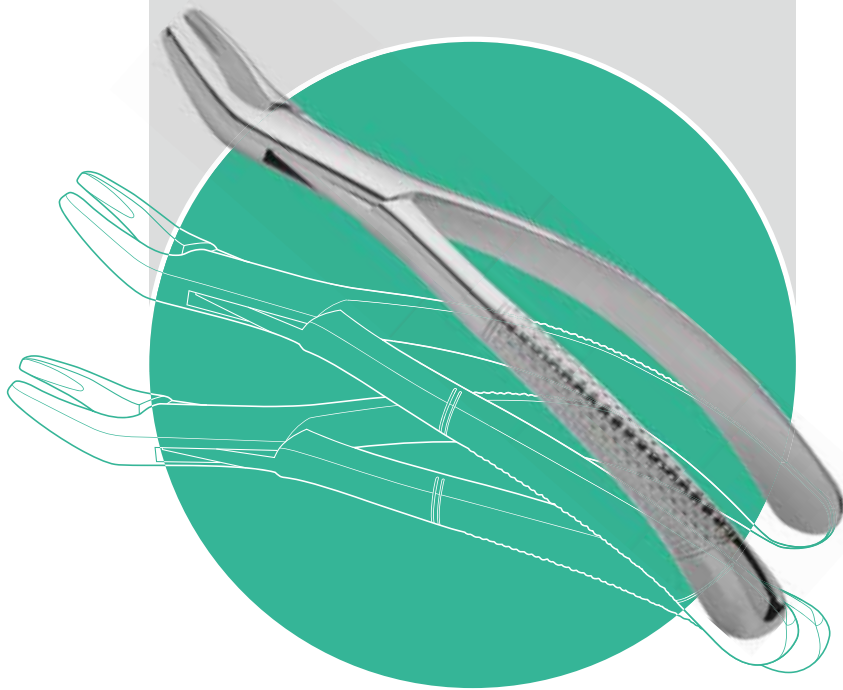

QUALITY
OUR WAY TO SUCCESS

Oral Instruments

拔牙钳(成人)
 Tooth Forceps For Adults



口腔科
 Oral Instruments



拔牙钳
 Tooth Forceps

★**ZR1101Rs**
 1#, 成人, 镶鳃式
 拔除上颌切牙用。
 For maxillary incisors

321	123
-----	-----



拔牙钳
 Tooth Forceps

★**ZR1102Rs**
 8#, 成人, 镶鳃式
 拔除上颌双尖牙用。
 For maxillary canine

54	45
----	----



拔牙钳
 Tooth Forceps

★**ZR1103Rs**
 10#, 成人, 镶鳃式
 拔除上颌第三磨牙用。
 For maxillary 3rd molar

76	67
----	----



拔牙钳
 Tooth Forceps

★**ZR1105Rs**
 15#, 成人, 镶鳃式
 拔除下颌磨牙用。
 For mandibular molars

76	67
----	----

拔牙钳(成人)
Tooth Forceps For Adults



拔牙钳
Tooth Forceps

★**ZR1106Rs**
16#, 成人, 镶鳃式
拔除下颌磨牙用。
For mandibular molars

76 | 67



拔牙钳
Tooth Forceps

★**ZR1107Rs**
17#, 成人, 镶鳃式
拔除下颌磨牙用。
For mandibular molars

76 | 67



拔牙钳
Tooth Forceps

★**ZR1108Rs**
18L#, 成人, 镶鳃式
拔除上颌左侧磨牙用。
For maxillary left molars

| 67



拔牙钳
Tooth Forceps

★**ZR1109Rs**
18R#, 成人, 镶鳃式
拔除上颌右侧磨牙用。
For maxillary right molars

76 |



口腔科
Oral Instruments

拔牙钳 (成人)
 Tooth Forceps For Adults

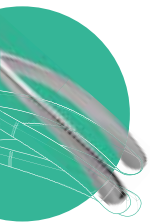

口腔科
 Oral Instruments



拔牙钳
 Tooth Forceps

★**ZR1113Rs**
 23#, 成人, 镶鳃式
 拔除下颌磨牙用
 For mandibular molars

76	67
----	----



拔牙钳
 Tooth Forceps

★**ZR1119Rs**
 32#, 成人, 镶鳃式
 拔除上颌双尖牙及牙根用
 For maxillary canines
 and roots

54	45
----	----



拔牙钳
 Tooth Forceps

★**ZR1124Rs**
 44#, 成人, 镶鳃式
 拔除下颌切牙及牙根用
 For mandibular incisors
 and roots

21	12
----	----



拔牙钳
 Tooth Forceps

★**ZR1126Rs**
 46#, 成人, 镶鳃式
 拔除下颌切牙用
 For mandibular incisors

321	123
-----	-----

拔牙钳 (成人)
Tooth Forceps For Adults



拔牙钳
Tooth Forceps

★**ZR1128Rs**
48#, 成人, 镶腮式
拔除下颌牙根用
For mandibular roots

R	R
---	---



拔牙钳
Tooth Forceps

ZR1133Rs
53L#, 成人, 镶腮式
拔除上颌左侧1、2磨牙用
For maxillary left 1st & 2nd molars

67



拔牙钳
Tooth Forceps

ZR1134Rs
53R#, 成人, 镶腮式
拔除上颌右侧1、2磨牙用
For maxillary right 1st & 2nd molars

76



口腔科
Oral Instruments

拔牙钳 (成人)
Tooth Forceps For Adults

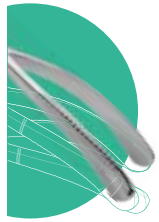

口腔科
Oral Instruments



拔牙钳
Tooth Forceps

★**ZR1138Rs**
65#, 成人, 镶鳃式
拔除上颌牙根用
For maxillary roots

R | R



拔牙钳
Tooth Forceps

★**ZR1143Rs**
69#, 成人, 镶鳃式
拔除碎片或小牙根用
For debris/small roots

R | R



拔牙钳
Tooth Forceps

★**ZR1150Rs**
150#, 成人, 镶鳃式
拔除上颌双尖牙及切牙用
For maxillary canines and incisors

5-1 | 1-5

拔牙钳 (成人)
Tooth Forceps For Adults



拔牙钳
Tooth Forceps

★**ZR1151Rs**
151#, 成人, 镶颧式
拔除下颌双尖牙及切牙用
For mandibular canines and incisors

5-1	1-5
-----	-----



拔牙钳
Tooth Forceps

★**ZR1160Rs**
210#, 成人, 镶颧式
拔除上颌第三磨牙用
For maxillary 3rd molar

8	8
---	---



拔牙钳
Tooth Forceps

★**ZR1162Rs**
222#, 成人, 镶颧式
拔除下颌第三磨牙用
For mandibular 3rd molar

8	8
---	---



口腔科
Oral Instruments

拔牙钳(儿童)
 Tooth Forceps For Children

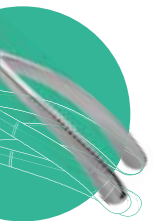

口腔科
 Oral Instruments



拔牙钳
 Tooth Forceps, Child

★**ZR1211Rs**
 1#, 儿童, 镶鳃式
 拔除上颌切牙用
 For maxillary incisors

321	123
-----	-----



拔牙钳
 Tooth Forceps, Child

★**ZR1212Rs**
 2#, 儿童, 镶鳃式
 拔除上颌牙根用
 For maxillary roots

R	R
---	---



拔牙钳
 Tooth Forceps, Child

★**ZR1213Rs**
 3#, 儿童, 镶鳃式
 拔除上颌切牙及牙根用
 For maxillary incisors & roots

321	123
-----	-----



拔牙钳
 Tooth Forceps, Child

★**ZR1214Rs**
 4#, 儿童, 镶鳃式
 拔除下颌切牙及牙根用
 For mandibular incisors & roots

321	123
-----	-----

拔牙钳(儿童)
Tooth Forceps For Children



拔牙钳
Tooth Forceps, Child

★**ZR1215Rs**
5#, 儿童, 镶鳃式
拔除下颌乳磨牙用
For mandibular
deciduous molars

54	45
----	----



拔牙钳
Tooth Forceps, Child

ZR1216Rs
6#, 儿童, 镶鳃式
切断乳牙用
For deciduous molars



拔牙钳
Tooth Forceps, Child

★**ZR1217Rs**
7#, 儿童, 镶鳃式
拔除下颌切牙用
For mandibular incisors

321	123
-----	-----



拔牙钳
Tooth Forceps, Child

★**ZR1218Rs**
8#, 儿童, 镶鳃式
拔除上颌乳磨牙用
For maxillary
deciduous molars

54	45
----	----



口腔科
Oral Instruments

拔牙钳(成人)
 Tooth Forceps For Adults

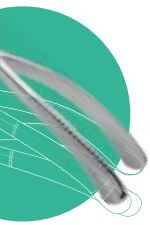

口腔科
 Oral Instruments



拔牙钳
 Tooth Forceps

★**ZR1101RB**
 1#, 成人, 镶鳃式
 拔除上颌切牙用
 For maxillary incisors

321	123
-----	-----



拔牙钳
 Tooth Forceps

★**ZR1102RB**
 8#, 成人, 镶鳃式
 拔除上颌双尖牙用
 For maxillary canines

54	45
----	----



拔牙钳
 Tooth Forceps

★**ZR1103RB**
 10#, 成人, 镶鳃式
 拔除上颌第三磨牙用
 For maxillary 3rd molar

76	67
----	----



拔牙钳
 Tooth Forceps

★**ZR1105RB**
 15#, 成人, 镶鳃式
 拔除下颌磨牙用
 For mandibular molars

76	67
----	----

拔牙钳(成人)
 Tooth Forceps For Adults



拔牙钳
 Tooth Forceps

★**ZR1106RB**
 16#, 成人, 镶鳃式
 拔除下颌磨牙用
 For mandibular molars

76	67
----	----



拔牙钳
 Tooth Forceps

★**ZR1107RB**
 17#, 成人, 镶鳃式
 拔除下颌磨牙用
 For mandibular molars

76	67
----	----



拔牙钳
 Tooth Forceps

★**ZR1108RB**
 18L#, 成人, 镶鳃式
 拔除上颌左侧磨牙用
 For mandibular left molars

	67
--	----



拔牙钳
 Tooth Forceps

★**ZR1109RB**
 18R#, 成人, 镶鳃式
 拔除上颌右侧磨牙用
 For mandibular right molars

76	
----	--



口腔科
 Oral Instruments

拔牙钳 (成人)
 Tooth Forceps For Adults



口腔科
 Oral Instruments



拔牙钳
 Tooth Forceps

★**ZR1113RB**
 23#, 成人, 镶鳃式
 拔除下颌磨牙用
 For mandibular molars

76	67
----	----



拔牙钳
 Tooth Forceps

★**ZR1119RB**
 32#, 成人, 镶鳃式
 拔除上颌双尖牙及牙根用
 For maxillary canines & roots

54	45
----	----



拔牙钳
 Tooth Forceps

★**ZR1124RB**
 44#, 成人, 镶鳃式
 拔除下颌切牙及牙根用
 For mandibular canines & roots

21	12
----	----



拔牙钳
 Tooth Forceps

★**ZR1126RB**
 46#, 成人, 镶鳃式
 拔除下颌切牙用
 For mandibular incisors

321	123
-----	-----

拔牙钳 (成人)
 Tooth Forceps For Adults



拔牙钳
 Tooth Forceps

★**ZR1128RB**
 48#, 成人, 镶鳃式
 拔除下颌牙根用
 For mandibular roots

R	R
---	---



拔牙钳
 Tooth Forceps

ZR1133RB
 53L#, 成人, 镶鳃式
 拔除上颌左侧1、2磨牙用
 For maxillary left
 1st & 2nd molars

	67
--	----



拔牙钳
 Tooth Forceps

ZR1134RB
 53R#, 成人, 镶鳃式
 拔除上颌右侧1、2磨牙用
 For maxillary right
 1st & 2nd molars

76	
----	--



拔牙钳
 Tooth Forceps

★**ZR1138RB**
 65#, 成人, 镶鳃式
 拔除上颌牙根用
 For maxillary roots

R	R
---	---



口腔科
 Oral Instruments

拔牙钳 (成人)
 Tooth Forceps For Adults

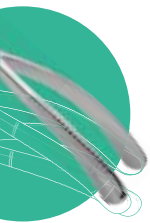

口腔科
 Oral Instruments



拔牙钳
 Tooth Forceps

★**ZR1143RB**
 69#, 成人, 镶鳃式
 拔除碎片或小牙根用
 For debris/small roots

R	R
---	---



拔牙钳
 Tooth Forceps

ZR1148RB
 88L#, 成人, 镶鳃式
 拔除上颌左侧1、2磨牙用
 For maxillary left
 1st & 2nd molars

	67
--	----



拔牙钳
 Tooth Forceps

ZR1149RB
 88R#, 成人, 镶鳃式
 拔除上颌右侧1、2磨牙用
 For maxillary right
 1st & 2nd molars

76	
----	--



拔牙钳
 Tooth Forceps

★**ZR1150RB**
 150#, 成人, 镶鳃式
 拔除上颌双尖牙及切牙用
 For maxillary canines & incisors

5-1	1-5
-----	-----

拔牙钳 (成人)
Tooth Forceps For Adults



拔牙钳
Tooth Forceps

★**ZR1151RB**

151#, 成人, 镶腮式
拔除下颌双尖牙及切牙用

For mandibular canines & incisors

5-1	1-5
-----	-----



拔牙钳
Tooth Forceps

★**ZR1160RB**

210#, 成人, 镶腮式
拔除上颌第三磨牙用

For maxillary 3rd molar

8	8
---	---



拔牙钳
Tooth Forceps

★**ZR1162RB**

222#, 成人, 镶腮式
拔除下颌第三磨牙用

For mandibular 3rd molar

8	8
---	---



口腔科
Oral Instruments

拔牙钳(儿童)
Tooth Forceps For Children

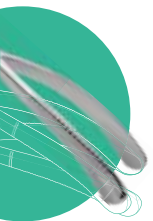

口腔科
Oral Instruments



拔牙钳
Tooth Forceps, Child

★**ZR1211RB**
1#, 儿童, 镶鳃式
拔除上颌切牙用
For maxillary incisors

321	123
-----	-----



拔牙钳
Tooth Forceps, Child

★**ZR1212RB**
2#, 儿童, 镶鳃式
拔除上颌牙根用
For maxillary roots

R	R
---	---



拔牙钳
Tooth Forceps, Child

★**ZR1213RB**
3#, 儿童, 镶鳃式
拔除上颌切牙及牙根用
For maxillary incisors & roots

321	123
-----	-----



拔牙钳
Tooth Forceps, Child

★**ZR1214RB**
4#, 儿童, 镶鳃式
拔除下颌切牙及牙根用
For mandibular incisors & roots

321	123
-----	-----

拔牙钳(儿童)
Tooth Forceps For Children



拔牙钳
Tooth Forceps, Child

★ZR1215RB

5#, 儿童, 镶鳃式
拔除下颌乳磨牙用
For mandibular
deciduous molars

54	45
----	----



拔牙钳
Tooth Forceps, Child

ZR1216RB

6#, 儿童, 镶鳃式
切断乳牙用
For deciduous molars



拔牙钳
Tooth Forceps, Child

★ZR1217RB

7#, 儿童, 镶鳃式
拔除下颌切牙用
For mandibular incisors

321	123
-----	-----



拔牙钳
Tooth Forceps, Child

★ZR1218RB

8#, 儿童, 镶鳃式
拔除上颌乳磨牙用
For maxillary
deciduous molars

54	45
----	----



口腔科
Oral Instruments

正畸钳
Orthodontic Pliers



正畸钳
Light Wire Plier(With cutter)

ZR1260RB

尖头两用

用于弯制各类弓丝不同弧度的精细弯曲, 及弯制各类弹簧曲, 钳喙中部带切断。



正畸钳
Light Wire Plier

★**ZR1261RB**

细丝弓弯制

用于弯制各类弓丝不同弧度的精细弯曲, 及弯制各类弹簧曲。



正畸钳
Distal End Cutter

★**ZR1262RB**

末端切断

用于切断过长的弓丝末端, 且能夹住剪下的扎丝头, 剪切扎口在0.5mm以下。

For cutting $\leq \phi 0.5\text{mm}$ wire



正畸钳
Ligature Cutter

★**ZR1263RB**

细丝切断

用于剪断直径0.3mm以下的结扎丝、橡皮圈等, (不能用来切断矫治主弓丝)。

For cutting $\leq \phi 0.3\text{mm}$ wire/rubber ring

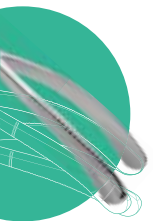

口腔科
Oral Instruments



正畸钳
Young Loop Bending Plier

ZR1265RB

欧米茄半月梯形

用于弯制精准的Ω曲。



正畸钳
Torque Bending Plier

★**ZR1266RB**

转矩形成

用于弯制形成方丝转矩。



正畸钳
Kim Plier

ZR1267RB

kim多曲方丝弓

用于弯制多曲方丝弓、钳喙中部带切断,

最大限度用于0.021×0.025英寸。
max range 0.021×0.025 inch

正畸钳
Orthodontic Pliers



正畸钳
How Plier

ZR1268RB

霍氏, 弯

用于将弓丝插入颊侧管中,
结扎弓丝或前牙带环的成形等。



正畸钳
How Plier

ZR1269RB

霍氏, 直

用于将弓丝插入颊侧管中,
结扎弓丝或前牙带环的成形等。



正畸钳
Distal End Bending Plier

ZR1270RB

末端回弯

用于弓丝的末端回弯。



正畸钳
Bracker Removing Plier

★ **ZR1271RB**

托槽拆除, 弯头 90°

用于拆除各种型号的后牙托槽。



正畸钳
Bracker Removing Plier

ZR1272RB

托槽拆除, 弯头 45°

用于拆除各种型号的后牙托槽。



正畸钳
Bracker Removing Plier

★ **ZR1273RB**

托槽拆除, 直头

用于拆除各种型号的前牙托槽。



正畸钳
Ceramic Bracker Removing Plier

ZR1274RB

陶瓷托槽拆除

用于拆除各种型号的前牙托槽。



正畸钳
Band Removing Plier

★ **ZR1275RB**

带环拆除

用于去除后牙区的带环及
除去直接粘于牙齿的托槽附件。

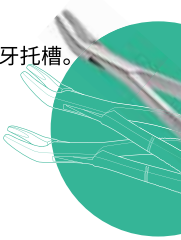

口腔科
Oral Instruments

正畸钳 Orthodontic Pliers



口腔科
Oral Instruments



正畸钳
Crimpable Hook
Placement

★ **ZR1276RB**
游离钩专用
用于锁定游离牵引钩于
弓丝的某一位置上，较
链连接采用偏心设计，
锁定操作轻松省力。



正畸钳
Lingual Ligature Cutter

★ **ZR1277RB**
舌侧细丝切断
用于剪切软态结扎丝或
橡皮圈等，主要用于舌侧。



正畸钳
Weingare Plier

ZR1278RB
细头温氏
用以夹特弓丝穿入颊管，
揭颊管盖及弓丝在颊管
后做末端回弯等。



正畸钳
Adhesive Removing Plier

ZR1279RB
粘接剂去除
用于刮除牙面正畸粘结剂，
而不损伤牙釉质。

隐形正畸钳
Thermal Forming Plier

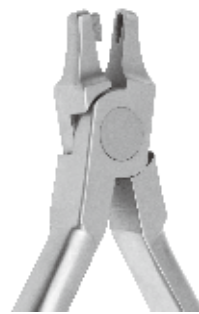

正畸钳
Tear Drop Thermal
Forming Plier

★ ZR1280RB

隐形正畸,泪滴剪孔

在透明矫治器龈向边缘,根据牵引的需要剪出水滴形缺口,以便勾住弹性橡皮圈,配合其他粘接附件,达到牵引的目的。



正畸钳
Hole Thermal
Forming Plier

★ ZR1281RB

隐形正畸,圆弧剪孔

在透明矫治器龈向边缘剪出一个半圆形缺口,为牙面粘接舌侧扣或托槽提供空间,从而不影响透明矫治器的佩戴,另外,剪掉需要软组织缓冲的部位,防止透明矫治器压迫牙龈。



正畸钳
Horizontal Notch
Thermal Forming Plier

★ ZR1282RB

隐形正畸,
水平凹槽热成型

在透明矫治器上添加水平向的凹陷,来实现对个别牙根的转矩加力,同时可增加对透明矫治器的固位。



正畸钳
Vertical Notch
Thermal Forming Plier

★ ZR1283RB

隐形正畸,
垂直凹槽热成型

在透明矫治器上添加竖向的凹陷来提高对扭转牙的控制。

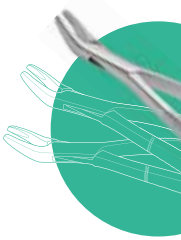

口腔科
Oral Instruments

隐形正畸钳
Thermal Forming Plier

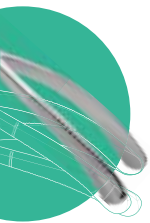

口腔科
Oral Instruments

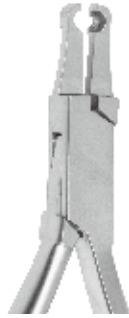

正畸钳
Groove Thermal
Forming Plier

★**ZR1284RB**
隐形正畸,槽沟热成型
在给透明矫正器添加了牵引钩后,能够继续给透明矫治器添加槽沟状倒凹,以便把持住橡皮圈,不至于随时脱出。



正畸钳
Circular Thermal
Forming Plier

★**ZR1285RB**
隐形正畸,环形热成型
增加已有凹面深度,提升钩的高度。



正畸钳
Micro Ramp
Thermal Forming Plier

★**ZR1286RB**
隐形正畸,微堤热成型
给透明矫治器添加突起,用于关闭间隙。



正畸钳
Bubble Thermal
Forming Plier

★**ZR1287RB**
隐形正畸,气泡热成型
为牙齿移动,给透明矫治器添加额外的空间。

技工钳
Hard Wire Cutter



技工钳
Hard Wire Cutter
ZR1264R
粗丝切断

牙槽咬骨钳
Bone Rongeur Forceps



牙槽咬骨钳
Bone Rongeur Forceps
★**ZR1310RB**
圆口



牙槽咬骨钳
Bone Rongeur Forceps
★**ZR1311RB**
方口

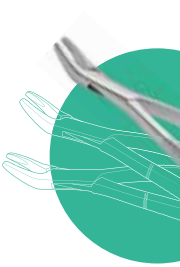

口腔科
Oral Instruments

技工钳
Laboratory Pliers

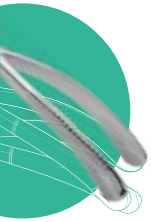

口腔科
Oral Instruments



技工钳
Laboratory Pliers
ZR1320R
成形钳, 107#



技工钳
Laboratory Pliers
★ZR1323R
梯形钳, 113#



技工钳
Laboratory Pliers
ZR1325R
成形钳, 115#



技工钳
Laboratory Pliers
★ZR1326R
卡环钳, 116#



技工钳
Laboratory Pliers
ZR1327R
成形钳, 118#



技工钳
Laboratory Pliers
ZR1328R
成形钳, 120#

技工钳
Laboratory Pliers



技工钳
Laboratory Pliers
★**ZR1329R**
成形钳, 121#



技工钳
Laboratory Pliers
ZR1330R
成形钳, 122#



技工钳
Laboratory Pliers
★**ZR1331R**
三德钳, 127#



技工钳
Laboratory Pliers
ZR1333R
日月钳(小), 134#



技工钳
Laboratory Pliers
★**ZR1334R**
日月钳, 134#



技工钳
Laboratory Pliers
ZR1337R
成形钳, 137#



技工钳
Laboratory Pliers
★**ZR1339R**
成形钳, 139#



技工钳
Laboratory Pliers
★**ZR1340R**
成形钳, 147#

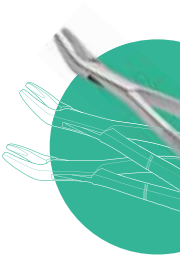

口腔科
Oral Instruments

技工钳
Laboratory Pliers

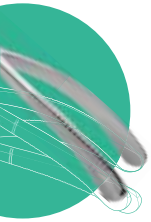

口腔科
Oral Instruments



技工钳
Laboratory Pliers
ZR1341RB
预成冠卷边



技工钳
Laboratory Pliers
ZR1342RB
预成冠缩颈

牙挺
Root Elevators



★ **ZR1415RB**
直头, 宽2 tip W.2

★ **ZR1371RB**
1#, 直头, 宽2.5 tip W.2.5
Straight



★ **ZR1372RB**
2#, 直头, 宽3 tip W.3

ZR1416RB
直头, 宽3.5 tip W.3.5
Straight



★ **ZR1373RB**
3#, 直头, 宽4 tip W.4

ZR1417RB
直头, 宽4.5 tip W.4.5

ZR1418RB
直头, 宽5 tip W.5
Straight



★ **ZR1419RB**
弯头, 宽2 tip W.2

ZR1420RB
弯头, 宽2.5 tip W.2.5
Curved



★ **ZR1374RB**
4#, 弯头, 宽3 tip W.3

ZR1421RB
弯头, 宽3.5 tip W.3.5
Curved



★ **ZR1375RB**
5#, 弯头, 宽4 tip W.4

ZR1422RB
弯头, 宽4.5 tip W.4.5

★ **ZR1376RB**
6#, 弯头, 宽5 tip W.5
Curved



口腔科
Oral Instruments

牙挺
Root Elevators



★**ZR1377RB**
27#, 右, 头宽9.5
Right tip W.9.5



★**ZR1378RB**
28#, 左, 头宽9.5
Left tip W.9.5



★**ZR1379RB**
302#, 右, 头宽2.5
Right tip W.2.5



★**ZR1380RB**
303#, 左, 头宽2.5
Left tip W.2.5



★**ZR1381RB**
S4, 三角头



★**ZR1382RB**
S5, 三角头



★**ZR1383RB**
S8, 弯头
Curved



★**ZR1384RB**
S9, 弯头
Curved

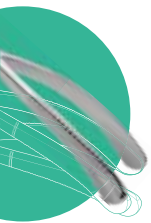

牙根尖挺
Apical Elevators



★ZR1404RB
1#



★ZR1405RB
2#



★ZR1406RB
3#



牙挺 (开冠挺)
Crown Remover/ Spreaders



★ZR1425RB
开冠挺, 直头
Straight



★ZR1426RB
开冠挺, 弯头45°
Curved



★ZR1427RB
开冠挺, 弯头90°
Curved

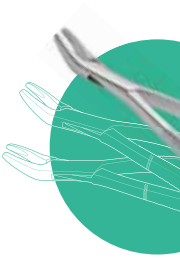

口腔科
Oral Instruments

丁字形牙挺
Root Elevators Type T

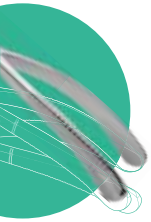

口腔科
Oral Instruments



★**ZR1411RB**
1#, 丁字形, 左
Left



★**ZR1412RB**
2#, 丁字形, 右
Right



★**ZR1413RB**
3#, 丁字形, 左
Left



★**ZR1414RB**
4#, 丁字形, 右
Right

牙挺 (微创牙挺)
Luxating Elevators



★**ZR1391RB**
1#, 微创, 直头, 宽2.5
Straight tip W.2.5



★**ZR1392RB**
2#, 微创, 弯头, 宽2.5
Curved tip W.2.5



★**ZR1393RB**
3#, 微创, 直头, 宽3
Straight tip W.3



★**ZR1394RB**
4#, 微创, 弯头, 宽3
Curved tip W.3

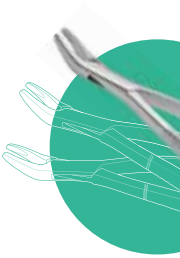

口腔科
Oral Instruments

微创牙挺
Micro-Invasive Root Elevators

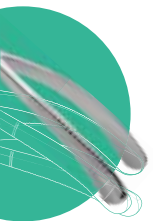

口腔科
Oral Instruments



ZR1361RB
1#, 2mm, 直刃
Straight



ZR1362RB
2#, 3mm, 弯刃
Curved



ZR1363RB
3#, 3mm, 直刃
Straight



ZR1364RB
4#, 3mm, 反向弯曲
Contra angle



ZR1365RB
5#, 3mm, 反角弯曲
Inverted curved



ZR1366RB
6#, 5mm, 弯刃
Curved



ZR1367RB
7#, 5mm, 直刃
Straight



ZR1368RB
8#, 3/1.5mm, 直, 双刃
Straight dual edge



ZR1369RB
9#, 5/3mm, 直, 双刃
Straight dual edge

微创牙挺
Micro-Invasive Root Elevators



ZR1357RB
2mm, 直刃
Straight



ZR1358RB
2mm, 弯刃
Curved



ZR1359RB
3mm, 弯刃
Curved



口腔科
Oral Instruments

微创牙挺
Micro-Invasive Root Elevators



ZR1431RB
1#, 170×4, 远端, 双弯
Dual curved



ZR1432RB
2#, 170×4, 近端, 双弯
Dual curved



ZR1433RB
3#, 170, 直, 三角头
Straight



ZR1434RB
4#, 170×3, 直
Straight



ZR1435RB
5#, 170×3, 远端, 双弯
Dual curved



ZR1436RB
6#, 170×3, 弯
Curved

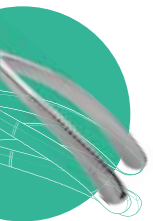

牙挺(阻生型)
Root Elevators
for Impacted Tooth



ZR1397RB
1#, 弯头, 宽3mm, 阻生型, 六角柄
Curved tip W.3



ZR1398RB
2#, 弯头, 宽4mm, 阻生型, 六角柄
Curved tip W.4



ZR1399RB
3#, 弯头, 宽5mm, 阻生型, 六角柄
Curved tip W.5

牙挺(增隙器)
Root Elevators



ZR1400RB
增隙型(增隙器)



口腔科
Oral Instruments

牙科剪、牙龈剪
Metal Crown Scissors、Gum Scissors

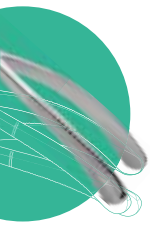

口腔科
Oral Instruments



牙科剪(金冠剪)
Metal Crown Scissors

- ★**ZR1440R**
110, 直头, 金冠
Straight
- ★**ZR1441R**
110, 弯头, 金冠
Curved



牙科剪(细丝剪)
Thin Wire Scissors

- ★**ZR1446R**
细丝, 有齿
Thin wire



牙龈剪
Gum Scissors

- ★**ZR1450RB**
130, 直
Straight

牙龈剪、技工石膏剪
Gum Scissors、Plaster Shear



牙龈剪
Gum Scissors
★**ZR1451RB**
130,弯
Curved



牙龈剪
Gum Scissors
★**ZR1452RB**
双弯
Double curved



技工石膏剪
Plaster Shear
★**ZR1460RB**
160
★**ZR1461RB**
200



口腔科
Oral Instruments

牙用镊
Dental Tweezers

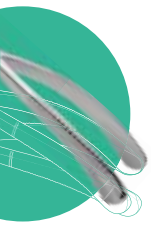

口腔科
Oral Instruments



牙用镊
★Dental Tweezers
ZR020R
160, 单弯
Single curved



牙用镊
Dental Tweezers
★**ZR021R**
160, 双弯
Double curved



牙用镊
Dental Tweezers
★**ZR022R**
160, 单弯, 定位
Single curved, with pin



牙用镊
Dental Tweezers

★**ZR023R**
160, 双弯, 定位
Double curved, with pin



牙用镊 (咬合纸镊)
Dental Tweezers

ZR1495R
咬合纸镊, 直
Straight
★**ZR1496R**
咬合纸镊, 弯
Curved



牙用镊
Dental Tweezers

★**ZR1497RB**
155mm, 缝合



口腔科
Oral Instruments

牙骨锤, 牙骨锉
Bone Chisel, Bone Files

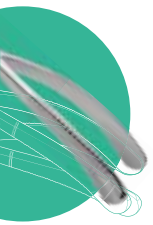

口腔科
Oral Instruments



牙骨锤
Bone Chisel
★ZK043R
180, 120g



牙骨锤
Bone Chisel
★ZR2139R
两头尼龙



牙骨锉
Bone Files
★ZR1511R
1#, 尖圆/尖圆
扁柄



牙骨锉
Bone Files
★ZR1512R
2#, 长圆/尖圆
扁柄

口镜(反光板)、口镜
Reflector、Reflector



口镜(反光板)
Reflector

- ★ **ZR1515R**
反光板式, 双面
Double-sided



口镜(口镜头)
Mouth Mirrors

- ★ **ZR1520R**
4#, 平光, 耐高温, $\phi 22$
Anti-heat Plain
- ★ **ZR1521R**
4#, 放大, 耐高温, $\phi 22$
Anti-heat Magnifying
- ★ **ZR1522R**
5#, 平光, 耐高温, $\phi 24$
Anti-heat Plain
- ★ **ZR1523R**
5#, 放大, 耐高温, $\phi 24$
Anti-heat Magnifying



口镜(口镜头)
Mouth Mirrors

- ★ **ZR1524R**
4#, 平光, 耐高温, 镀铬, $\phi 22$
Anti-heat Plain Rhodanized



口镜(口镜柄)
Mouth Mirrors Handle

- ★ **ZR1525R**
口镜柄



口腔科
Oral Instruments

牙用分离器(牙骨膜分离器)
Periosteals



牙用分离器(牙骨膜分离器)
Periosteals

★**ZR1541R**
牙骨膜分离,
1#, 双头
Double-ended



牙用分离器(牙骨膜分离器)
Periosteals

ZR1541RBs
牙骨膜分离,
1#, 双头, 硅胶柄
Silicone handle

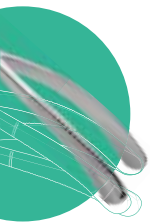

口腔科
Oral Instruments



牙用分离器(牙骨膜分离器)
Periosteals

★**ZR1542R**
牙骨膜分离,
2#, 双头
Double-ended



牙用分离器(牙骨膜分离器)
Periosteals

ZR1542RBs
牙骨膜分离,
2#, 双头, 硅胶柄
Silicone handle

牙用分离器(牙龈分离器)
Gingival Separators



牙用分离器(牙龈分离器)
Periosteals
ZR1538R
1#,双头,直



牙用分离器(牙龈分离器)
Periosteals
ZR1538RB
1#,双头,直,圆柄



牙用分离器(牙龈分离器)
Periosteals
ZR1539R
2#,双头,弯



牙用分离器(牙龈分离器)
Periosteals
ZR1539RB
2#,双头,弯,圆柄



口腔科
Oral Instruments

牙龈分离器 (牙龈压排器)
Gingival Separators



★ **ZR1543R**
牙龈压排
有齿圆头
With teeth

★ **ZR1544R**
牙龈压排
无齿圆头
Without teeth



牙龈分离器 (牙龈压排器)
Gingival Separators



★ **ZR1545R**
牙龈压排
有齿半圆头
With teeth

★ **ZR1546R**
牙龈压排
无齿半圆头
Without teeth

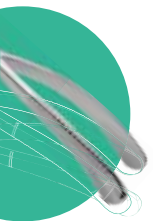

牙龈分离器
Gingival Separators



牙龈分离器
Gingival Separators
★ZR1547R
双头
Double-ended



ZR1547RB
190mm, 双头, 圆柄



ZR1547RBs
双头, 硅胶柄
Silicone handle

牙龈分离器(牙龈牵开器)
Gingival Retractor



ZR1548RB
1#



ZR1549RB
2#



口腔科
Oral Instruments

骨膜剥离器
Periosteum detacher



骨膜剥离器
Periosteum detacher

ZR2508RB
180, 宽4/4, 圆头, 平刃, 圆柄
ZR2520RB
190, 宽6/4, 圆头/平刃, 牙用



骨膜剥离器
Periosteum detacher

ZR2509RB
190×5.5×10,
圆头, 铲形, 圆柄



骨膜剥离器
Periosteum detacher

ZR2510RB
200×3×11.5,
圆头, V型头, 扁柄



骨膜剥离器
Periosteum detacher

ZR2511RB
180, 宽4/6, 圆柄



骨膜剥离器
Periosteum detacher

ZR2512RB
190×4×4, 双头, 直
ZR2521RB
200, 宽5/8, 双头, 圆柄, 牙用



骨膜剥离器
Periosteum detacher

ZR2513RB
185×4×4,
双头, 弯, 扁柄



骨膜剥离器, 置骨器
Periosteum detacher, Bone Placing Container



骨膜剥离器
Periosteum detacher

ZR2523RB
双头, 200×11, 锐口,
200×12, 钝口, 牙用



置骨器
Bone Placing Container

★**ZR2550RN**
30×φ40

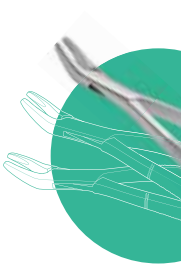

牙用输送器, 骨粉匙
Dental cement Carriers, Dental cement Scoop



牙用输送器
Dental cement Carriers

ZR2590RN
130×φ1.5

ZR2592RN
160×φ3.5
内径φ2.7

ZR2593RN
160×φ4.5
内径φ3.5

ZR2594RN
160×φ6
内径φ5



骨粉匙
Dental cement Scoop

ZR2587RB
190×10×6, 双头, 骨粉

口腔科
Oral Instruments

牙龈刀
Gum Knives

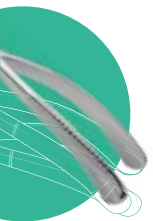

口腔科
Oral Instruments



牙龈刀
Gum Knives

★**ZR1571R**
1#, 切除,
斧刃左
Left



牙龈刀
Gum Knives

★**ZR1572R**
2#, 切除,
斧刃右
Right



牙龈刀
Gum Knives

★**ZR1574R**
4#, 尖刃



牙龈刀
Gum Knives

★**ZR1578R**
8#, 镰刀刃



牙龈刀
Gum Knives

ZR1581RB

1#, 切除, 斧刃左, 圆柄



牙龈刀
Gum Knives

ZR1582RB

2#, 切除, 斧刃右, 圆柄

牙龈刀, 石膏切刀, 石膏调刀
Gum Knives, Plaster Knives, Plaster Spatulas



牙龈刀
Gum Knives
ZR1583RB
4#, 尖刃, 圆柄



牙龈刀
Gum Knives
ZR1584RB
8#, 镰刀刃, 圆柄



石膏切刀
Plaster Knives
★**ZR1561RB**
常规, 5R



石膏调刀
Plaster Spatulas
★**ZR1562RB**
常规, 1R

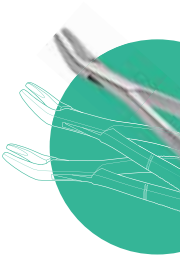

口腔科
Oral Instruments

牙用刀
Cement Spatulas

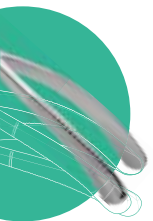

口腔科
Oral Instruments



牙用刀(粘固粉调刀)
Cement Spatulas

- ★**ZR1591R**
粘固粉调刀, 1#, 双头, 宽6mm
Double-ended
- ★**ZR1592R**
粘固粉调刀, 2#, 双头, 宽5mm
Double-ended



牙用刀(粘固粉调刀)
Cement Spatulas

- ZR1593R**
粘固粉调刀, 3#, 单头,
宽6mm
Single-ended



牙用刀(银汞雕刻刀)
Silver mercury
carving knife

- ZR1615R**
银汞雕刻刀, 5#, 双头



技工蜡型雕刻刀
Wax Carvers

- ★**ZR1630R**
C3, 八角柄

牙用刀
Cement Spatulas



技工蜡型雕刻刀
Wax Carvers
★ZR1631R
C4, 八角柄

技工蜡型雕刻刀
Wax Carvers
ZR1632R
C5, 八角柄

技工蜡型雕刻刀
Wax Carvers
★ZR1633R
C6, 八角柄

技工蜡型雕刻刀
Wax Carvers
ZR1634R
C10, 八角柄

技工蜡型雕刻刀
Wax Carvers
★ZR1635R
C11, 八角柄

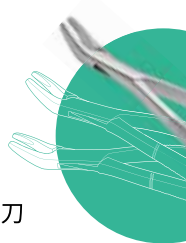

口腔科
Oral Instruments

牙用刀
Cement Spatulas

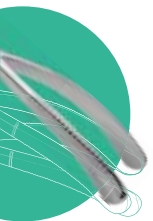

口腔科
Oral Instruments



技工蜡型雕刻刀
Wax Carvers
ZR1636R
C12, 八角柄



技工蜡型雕刻刀
Wax Carvers
ZR1638R
大蜡匙, 31#, 八角柄



技工蜡型雕刻刀
Wax Carvers
★ **ZR1641R**
双头, 47#, 八角柄



技工蜡型雕刻刀
Wax Carvers
★ **ZR1643R**
双头, 48#, 八角柄

牙用刀
Cement Spatulas



★ZR1661R 1# ZR1662R 2# ★ZR1663R 3# ZR1664R 4# ZR1665R 5#

托马斯雕刻刀
Thomas Waxing Instruments
双头Φ8
Double-ended



口腔科
Oral Instruments



蜡刀
Wax Carvers
★ZR1670R
180

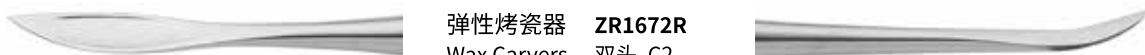

弹性烤瓷器
Wax Carvers ZR1672R
双头, C2
Double-ended

牙骨凿(牙周凿)
 Bone Chisels



ZR2559RB
 1#, 160, 牙周,
 单面刃

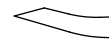

ZR2561RB
 3#, 160, 牙周,
 单面刃



ZR2560RB
 2#, 160, 牙周,
 双面刃

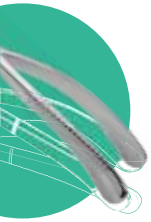

口腔科
 Oral Instruments

牙骨凿
 Bone Chisels



★**ZR1691RB**
 1#, 弯, 半圆刃,
 宽3
 Curved, 3mm



★**ZR1692RB**
 2#, 直, 单面刃,
 宽3.5
 Straight, 3.5mm



★**ZR1693RB**
 3#, 直, 半圆刃,
 宽3
 Straight, 3mm



★**ZR1694RB**
 4#, 直, 双面刃,
 宽5
 Straight, 5mm



ZR1695RB
 5#, 直, 双面刃,
 宽3.5
 Straight, 3.5mm

ZR1696RB
 6#, 直, 单面刃,
 宽5
 Straight, 5mm

阻生牙骨凿, 牙骨凿
Bone Chisels, Bone Chisels



阻生牙骨凿
Bone Chisels



★**ZR1681RB**
1#, 月牙刃



★**ZR1682RB**
2#, 半圆刃



★**ZR1683RB**
3#, 弯月牙刃
Curved



ZR1684RB
4#, 弯半圆刃
Curved



★**ZR1685RB**
5#, 直刃
Straight



ZR2608RB
150×4, 直刃

牙骨凿
Bone Chisels



ZR2614RB
160×4, 双面刃,
直, 带刻度
graduated

ZR2615RB
160×7, 双面刃,
直, 带刻度
graduated



ZR2616RB
160×4, 双面刃,
弯, 带刻度
graduated

ZR2617RB
160×7, 双面刃,
弯, 带刻度
graduated



口腔科
Oral Instruments

牙骨凿
Bone Chisels



口腔科
Oral Instruments



★ZR2610RB
宽4, 直, 带刻度,
骨劈开



★ZR2611RB
宽6, 直, 带刻度,
骨劈开



★ZR2613RB
宽4, 弯, 带刻度,
骨劈开



★ZR2612RB
宽6, 弯, 带刻度,
骨劈开

骨凿
Bone Chisels



ZR2621RB
140×2, 直, 双斜刃

骨凿
Bone Chisels,
Straight



ZR2609RB
140×4, 直, 双斜刃



ZR2622RB
140×6, 直, 双斜刃



ZR2623RB
140×8, 直, 双斜刃



ZR2624RB
140×2, 弯, 双斜刃

骨凿
Bone Chisels,
Curved



ZR2606RB
140×4, 弯, 双斜刃



ZR2626RB
140×6, 弯, 双斜刃



ZR2627RB
140×8, 弯, 双斜刃

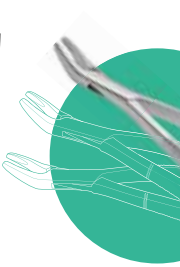

口腔科
Oral Instruments

牙釉凿
Dental Chisels

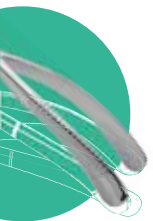

口腔科
Oral Instruments



ZR1701R
1#, 直刃, 宽5
Straight, 5mm



ZR1702R
2#, 直刃, 宽4
Straight, 4mm



★**ZR1703R**
3#, 直刃, 宽3
Straight, 3mm



★**ZR1704R**
4#, 直刃, 宽2
Straight, 2mm



★**ZR1705R**
5#, 直刃, 宽1.5
Straight, 1.5mm



ZR1706R
6#, 倒锥直刃, 宽5.5
Straight, 5.5mm

骨刮匙
Bone Scraper



ZR2640RB
180×2×4,
直头, 弯头

ZR2641RB
180×3×5,
直头, 弯头

ZR2642RB
180×4×6,
直头, 弯头

牙科骨挤压器
 Bone Spreader

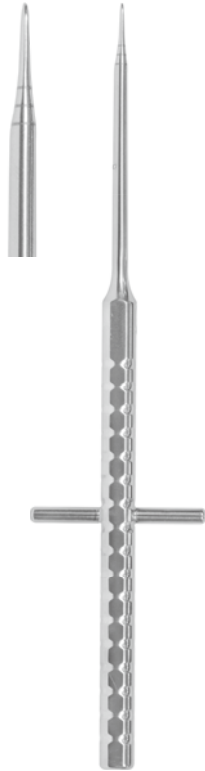

ZR2661RB
 165,1.6/2.2,直杆,矛形

ZR2662RB
 165,2.2/2.8,直杆,矛形

ZR2663RB
 165,2.8/3.4,直杆,矛形

ZR2664RB
 165,3.4/4.0,直杆,矛形



ZR2665RB
 165,1.6/2.2,弯杆,矛形

ZR2666RB
 165,2.2/2.8,弯杆,矛形

ZR2667RB
 165,2.8/3.4,弯杆,矛形

ZR2668RB
 165,3.4/4.0,弯杆,矛形



牙刮匙
 Bone Curettes



双头
 Double-curved
 double-ended



★**ZR1741R**
 1#,直匙形,头宽5/2.5



★**ZR1742R**
 2#,双弯匙形,头宽3



★**ZR1743R**
 3#,双弯匙形,头宽5



口腔科
 Oral Instruments

牙刮匙
 Bone Curettes



★**ZR1721R**
 1#, 直铲形,
 双头, 头宽2.5/5
 Straight



★**ZR1722R**
 2#, 双弯铲形,
 双头, 头宽2.5
 Double-curved



★**ZR1723R**
 3#, 双弯铲形,
 双头, 头宽3.5
 Double-curved



★**ZR1724R**
 4#, 双弯铲形,
 双头, 头宽4.5
 Double-curved

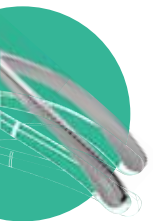

口腔科
 Oral Instruments

牙刮匙
 Bone Curettes



无齿 1#-4#



ZR1721RBs
 1#, 直铲形,
 双头, 硅胶柄
 190×2.5×5



ZR1722RBs
 2# 双弯铲形,
 双头, 硅胶柄
 头宽2.5

ZR1723RBs
 3#, 双弯铲形,
 双头, 硅胶柄
 头宽3.5

ZR1724RBs
 4# 双弯铲形,
 双头, 硅胶柄
 头宽4.5

牙刮匙(锐)
 Bone Currettes



★**ZR1781R**
 1#, 双弯铲形, 锐,
 双头, 头宽2.3
 Double-curved
 Sharp



★**ZR1782R**
 2#, 双弯铲形, 锐,
 双头, 头宽3
 Double-curved
 Sharp



ZR1781RBs
 1#, 双弯铲形, 锐,
 双头, 硅胶柄
 头宽2.3



ZR1782RBs
 2#, 双弯铲形, 锐,
 双头, 硅胶柄
 头宽3



ZR1793RB
 185×2.5,
 双弯铲形, 锐, 双头

ZR1783RB
 185×3,
 双弯铲形, 锐, 双头

ZR1794RB
 185×3.5,
 双弯铲形, 锐, 双头

ZR1795RB
 185×4.5,
 双弯铲形, 锐, 双头

牙刮匙(带齿)
 Bone Currettes



ZR1786RBs
 1#, 双弯铲形,
 带齿, 双头,
 硅胶柄



ZR1784RBs
 2#, 双弯铲形,
 带齿, 双头,
 硅胶柄



ZR1785RBs
 3#, 双弯铲形,
 带齿, 双头,
 硅胶柄



ZR1786RB
 1#, 双弯铲形,
 带齿, 双头, 圆柄

ZR1784RB
 2#, 双弯铲形,
 带齿, 双头, 圆柄

ZR1785RB
 3#, 双弯铲形,
 带齿, 双头, 圆柄



ZR1786R
 1#, 双弯铲形,
 带齿, 双头

ZR1784R
 2#, 双弯铲形,
 带齿, 双头

ZR1785R
 3#, 双弯铲形,
 带齿, 双头



口腔科
 Oral Instruments

刮治器
Curettes

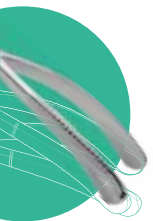

口腔科
Oral Instruments



ZR1801R
1#



ZR1802R
2#



ZR1803R
3#



ZR1804R
4#



ZR1805R
5#



ZR1806R
6#



ZR1807R
7#



ZR1808R
8#



ZR1809R
9#



ZR1810R
10#



ZR1811R
11#



ZR1812R
12#

刮治器
Curettes
单头
Single-ended

刮治器
Gracey Curettes



刮治器
Gracey Curettes
双头, 实心圆柄
Double-ended



★ ZR1831RB
1#-2#, 双头



★ ZR1832RB
3#-4#, 双头



★ ZR1833RB
5#-6#, 双头



★ ZR1834RB
7#-8#, 双头



★ ZR1835RB
9#-10#, 双头



★ ZR1836RB
11#-12#, 双头



★ ZR1837RB
13#-14#, 双头



★ ZR1838RB
15#-16#, 双头



★ ZR1839RB
17#-18#, 双头



口腔科
Oral Instruments

刮治器
Gracey Curettes



ZR1831RBs
1#-2#, 双头

ZR1832RBs
3#-4#, 双头

★ ZR1833RBs
5#-6#, 双头

★ ZR1834RBs
7#-8#, 双头

ZR1835RBs
9#-10#, 双头



★ ZR1836RBs
11#-12#, 双头

★ ZR1837RBs
13#-14#, 双头

ZR1838RBs
15#-16#, 双头

ZR1839RBs
17#-18#, 双头

口腔科
Oral Instruments

刮治器
Gracey Curettes
双头, 硅胶柄
Silicone handle

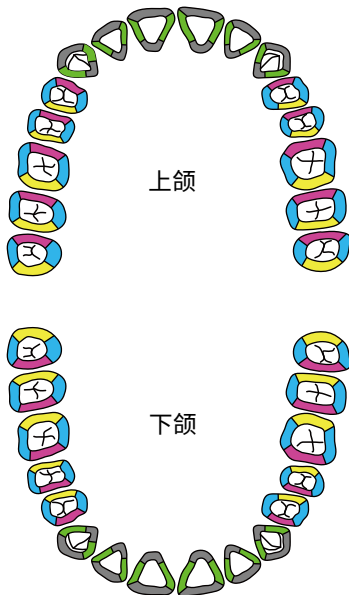

刮治器
Gracey Curettes
使用部位参考图

-  前牙区
1#/2#, 3#/4#, 5#/6#
-  舌侧/颊侧
7#/8#, 9#/10#
-  磨牙近中面
11#/12#, 15#/16#
-  磨牙远中面
13#/14#, 17#/18#

洁治器
Scalers



★ZR1851R
1#



★ZR1852R
2#



★ZR1853R
3#



★ZR1854R
4#



★ZR1855R
5#



★ZR1856R
6#



★ZR1857R
7#



★ZR1858R
8#



ZR1859R
9#

洁治器
Scalers

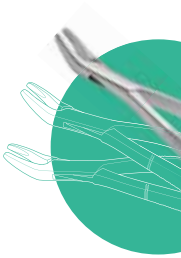

口腔科
Oral Instruments



★**ZR1871R**
 1#, 单弯, 头宽1
 双头
 Single curved
 double-ended



★**ZR1872R**
 2#, 双弯, 头宽1.2
 双头
 Double curved
 double-ended



★**ZR1873R**
 3#, 双弯, 头宽1.4
 双头
 Double curved
 double-ended



★**ZR1874R**
 4#, 双弯, 头宽1.6
 双头
 Double curved
 double-ended



★**ZR1875R**
 5#, 双弯, 头宽2
 双头
 Double curved
 double-ended



★**ZR1876R**
 6#, 双弯, 头宽2.2
 双头
 Double curved
 double-ended



剔挖器
 Excavators

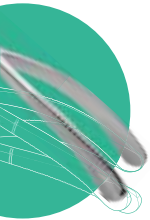

口腔科
 Oral Instruments



剔挖器
 Excavators single curved

ZR1871RBs
 1# 单弯, 头宽1, 双头, 硅胶柄



剔挖器
 Excavators double curved

ZR1872RBs
 2# 双弯, 头宽1.2,
 双头, 硅胶柄

ZR1873RBs
 3# 双弯, 头宽1.4,
 双头, 硅胶柄

ZR1874RBs
 4# 双弯, 头宽1.6,
 双头, 硅胶柄

ZR1875RBs
 5# 双弯, 头宽2,
 双头, 硅胶柄

ZR1876RBs
 6# 双弯, 头宽2.2,
 双头, 硅胶柄



研光器
 Burnishers



ZR1901R
 1#

★ZR1902R
 2#

★ZR1903R
 3#

★ZR1904R
 4#

ZR1905R
 5#

ZR1906R
 6#

研光器
 Burnishers
 单头
 Single-ended



口腔科
 Oral Instruments

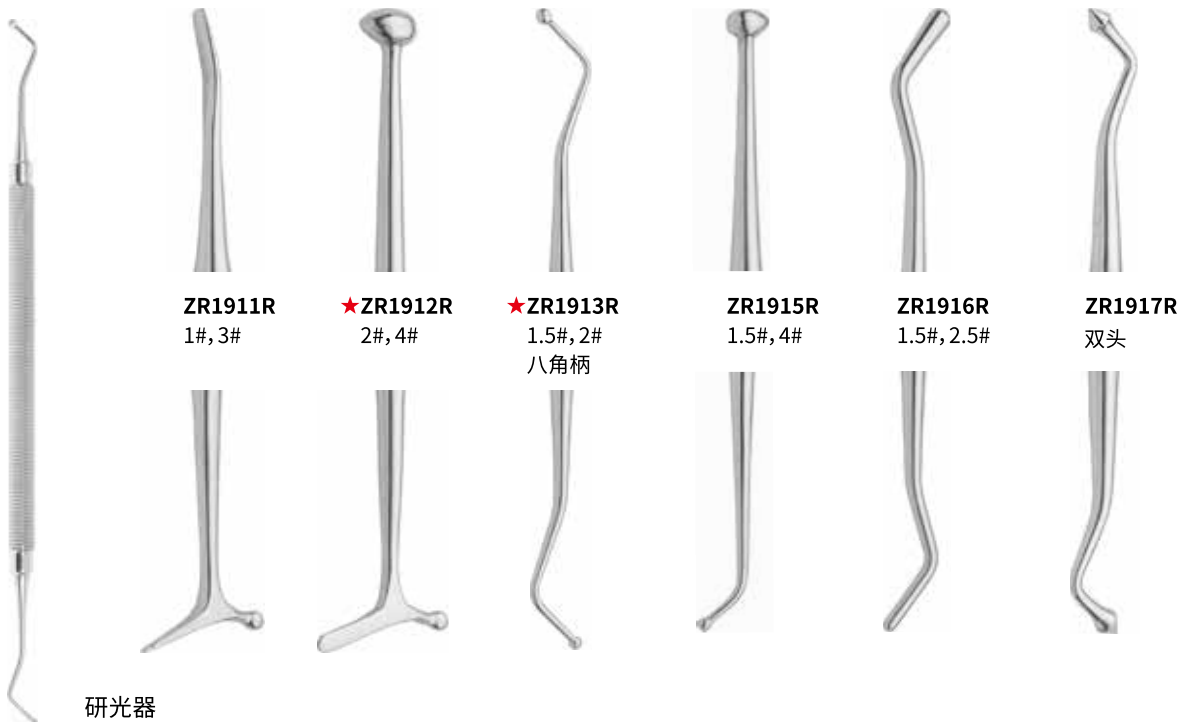

ZR1911R
 1#, 3#

★ZR1912R
 2#, 4#

★ZR1913R
 1.5#, 2#
 八角柄

ZR1915R
 1.5#, 4#

ZR1916R
 1.5#, 2.5#

ZR1917R
 双头

研光器
 Burnishers
 双头
 Double-ended

研光器
Burnishers double ended

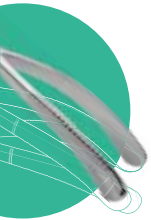

口腔科
Oral Instruments



ZR1912RBs
2#, 4#, 双头, 硅胶柄



ZR1913RBs
1.5#, 2#, 双头, 硅胶柄



ZR1917RBs
双头, 硅胶柄



牙探针
 Explorers



★ ZR1951RB
 1#, 八角柄

★ ZR1952RB
 2#, 八角柄

★ ZR1941RB
 5#, 八角柄

★ ZR1953RB
 6#, 八角柄

★ ZR1942RB
 DG16#

牙探针
 Explorers
 双头
 Double-ended



★ ZR1954RB
 7#

ZR1955RB
 9#

ZR1956RB
 10#

ZR1957RB
 11#

ZR1958RB
 12#

ZR1959RB
 13#

ZR1960RB
 14#

牙探针
 Explorers
 单头
 Single-ended

ZR1961RB
 17#

ZR1962RB
 21#

ZR1963RB
 22#

★ ZR1964RB
 23#



口腔科
 Oral Instruments

牙周袋探针
Periodontal Probe

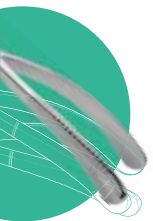

口腔科
Oral Instruments



★ ZR2001RB
扁刻 (1-10)

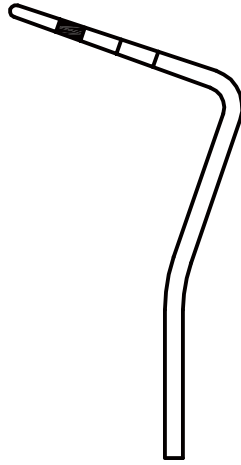

★ ZR2004RB
(3.5-5.5-8.5-11.5)

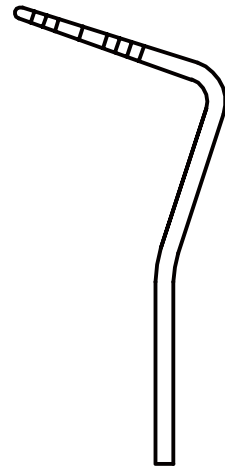

ZR2005RB
(1-2-3-5-7-8-9-10)

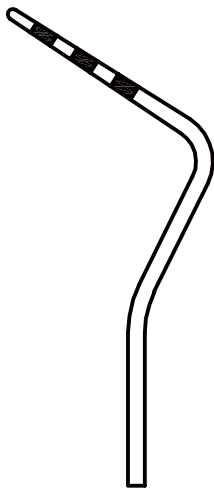

★ ZR2006RB
(2-12)

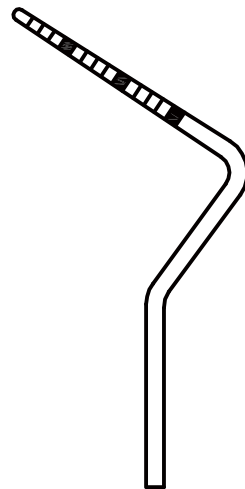

★ ZR2007RB
(1-15)

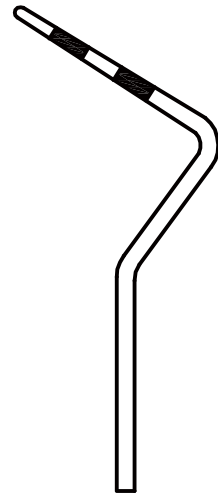

ZR2008RB
(3-6-9-12)

牙周袋探针
Periodontal Probe

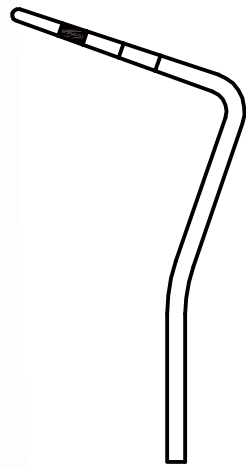

ZR2009RB
160mm, 圆柄
(3.5-5.5-8.5-11.5)

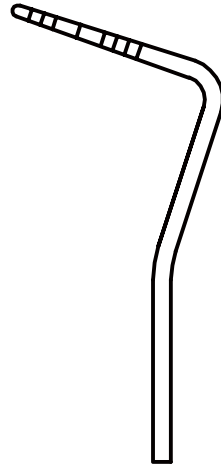

ZR2010RB
160mm, 圆柄
(1-2-3-5-7-8-9-10)

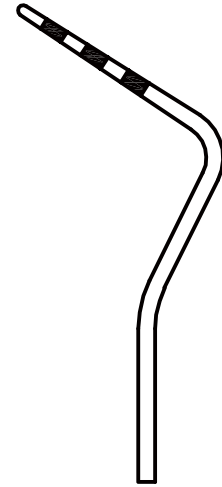

ZR2011RB
160mm, 圆柄
(2-12)

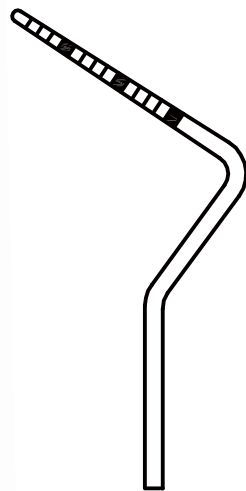

ZR2012RB
160mm, 圆柄
(1-15)

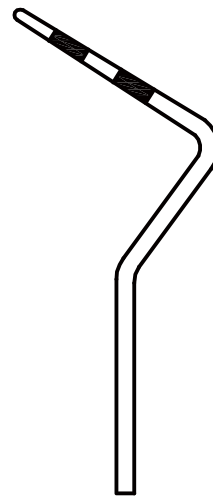

ZR2013RB
160mm, 圆柄
(3-6-9-12)

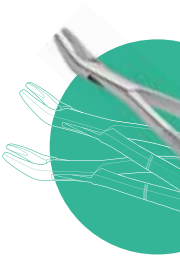

口腔科
Oral Instruments

牙周袋探针
Periodontal Probe



口腔科
Oral Instruments



ZR2014RB
球形, CPI探针
(3.5-5.5-8.5-11.5)

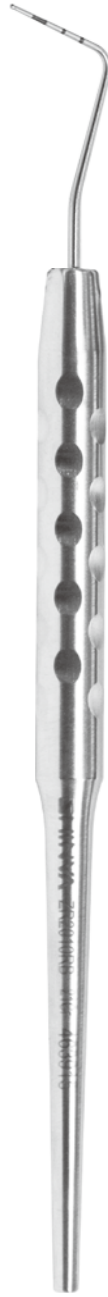

ZR2015RB
150mm, 球形, 圆柄, CPI探针
(3.5-5.5-8.5-11.5)



ZR2016RB
双头, 根分叉,
(3-6-9-12)



ZR2017RB
双头, 根分叉, 圆柄
(3-6-9-12)

根管充填器(垂直加压器)、根管充填器(侧压器)、根管充填器
Pluggers/Condensers, Spreaders, Root-canal Pluggers



口腔科
Oral Instruments

粘固粉充填器
Cement Pluggers

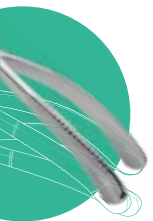

口腔科
Oral Instruments



★ZR2061R
1#, 双头



★ZR2062R
2#, 双头



★ZR2063R
3#, 双头



★ZR2064R
4#, 双头



粘固粉充填器
Cement Pluggers
双头
Double-ended

粘固粉充填器
Cement Pluggers



粘固粉充填器
Cement Pluggers
双头
Double-ended
ZR2062RBs
2#, 双头, 硅胶柄



粘固粉充填器
Cement Pluggers
双头
Double-ended
ZR2063RBs
3#, 双头, 硅胶柄



粘固粉充填器
Cement Pluggers
双头
Double-ended
ZR2064RBs
4#, 双头, 硅胶柄

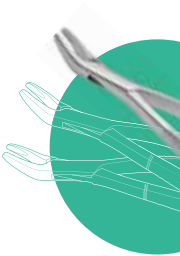

口腔科
Oral Instruments

银汞合金充填器, 玻璃离子充填器
Amalgam Pluggers, Glass Ion Fillers

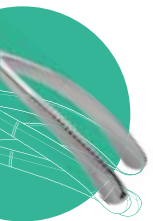

口腔科
Oral Instruments



银汞合金充填器
Amalgam Pluggers
双头
Double-ended

- ★ ZR2086R
160, 双头, $\Phi 1-\Phi 2$
- ★ ZR2087R
160, 双头, $\Phi 1.5-2.5$



玻璃离子充填器
Glass Ion Fillers

ZR2088RB
170× $\Phi 0.85$ × $\Phi 1$, 弯, 双头



牙科树脂充填器(树脂修正器)
Dental Plastic Filling Instruments



牙科树脂充填器
Dental Plastic Filling
Instruments

★**ZR2110R**
树脂充填



牙科树脂充填器(树脂修正器)
Dental Plastic Filling Instruments

ZR2100R
树脂修正



牙科树脂充填器(树脂修正器)
Dental Plastic Filling Instruments

★**ZR2105RB**
树脂修正,圆柄



口腔科
Oral Instruments

牙科树脂充填器
Dental Resin Filling Instruments

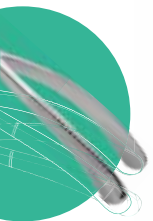

口腔科
Oral Instruments

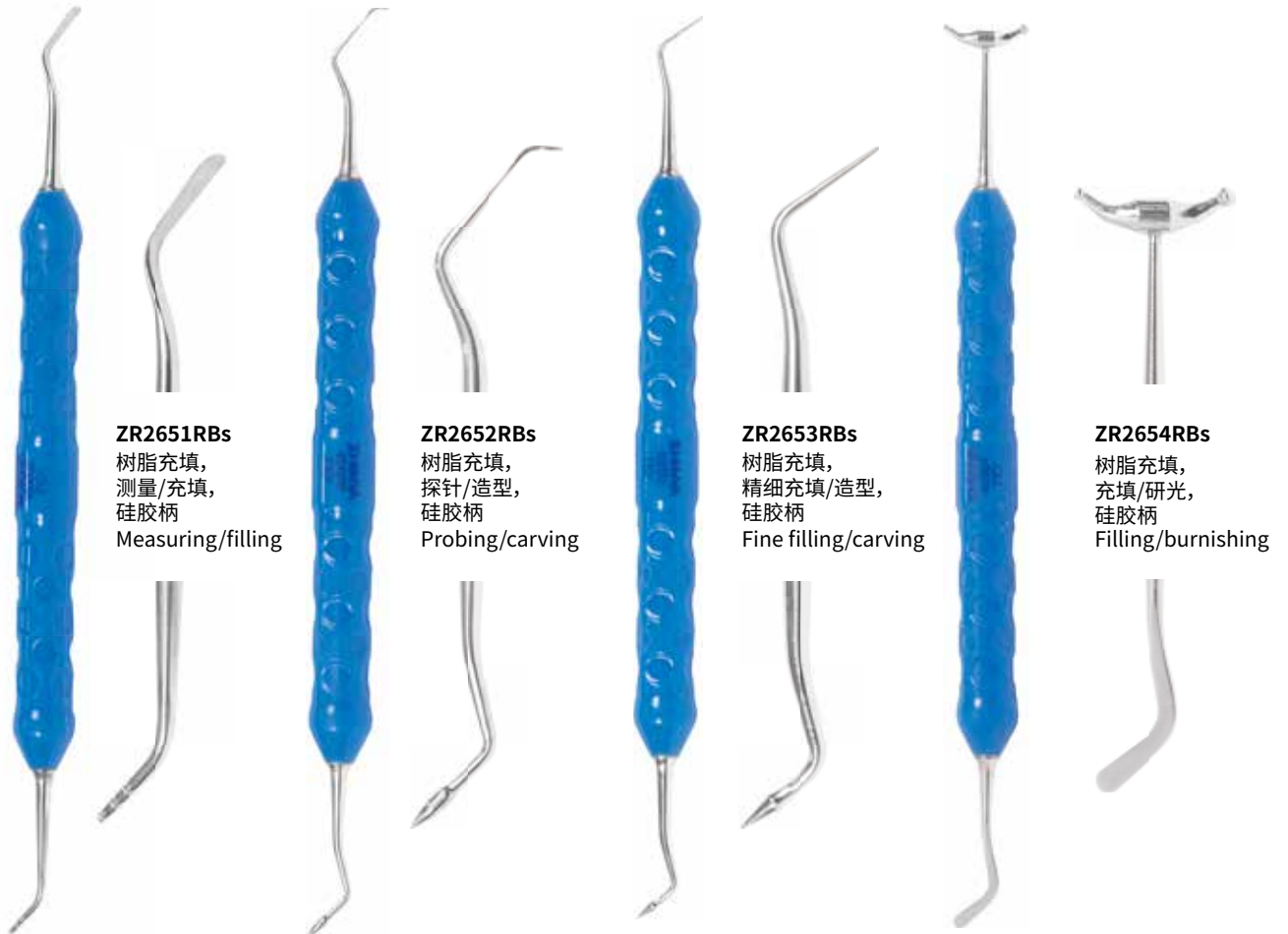

牙科树脂充填器
Dental Resin Filling Instruments



ZR2655RBs
树脂修正,
硅胶柄,
高弹



ZR2105RBs
树脂修正,
硅胶柄



ZR2110RBs
树脂充填,
硅胶柄

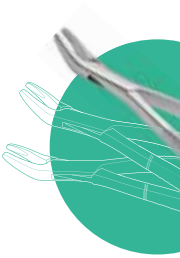

口腔科
Oral Instruments

牙科树脂充填器
Dental Resin Filling Instruments

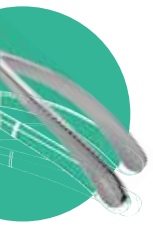

口腔科
Oral Instruments



ZR2643RB
成型,
双头, 圆柄
Shaping



ZR2644RB
树脂充填,
双头, 圆柄
Filling



ZR2645RB
雕刻,
双头, 圆柄
Carving



ZR2646RB
修整,
双头, 圆柄, 高弹
Trimming



牙科树脂充填器
Dental Resin Filling Instruments



ZR2647RB
釉质测量,
双头, 圆柄
Measuring



ZR2648RB
刮除,
双头, 圆柄
Curette



ZR2649RB
平铺测量,
双头, 圆柄
Measuring

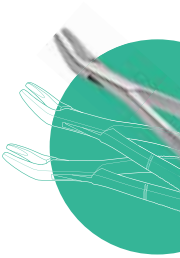

口腔科
Oral Instruments

口腔麻醉注射架
Aspirating Syringes



口腔科
Oral Instruments



口腔麻醉注射架
Aspirating Syringes

★**ZR2115RB**
钩头, 公制/英制, 丝头可换
Hook, metric/British



口腔麻醉注射架
Aspirating Syringes

★**ZR2116RB**
尖头, 公制/英制, 丝头可换
Sharp, metric/British



口腔麻醉注射架
Aspirating Syringes

ZR2113RB
尖头, 公制, 丝头固定 sharp,metric

ZR2114RB
尖头, 英制, 丝头固定 sharp,British

ZR2111RB
钩头, 公制, 丝头固定 hook,metric

ZR2112RB
钩头, 英制, 丝头固定 hook,British

口腔麻醉注射架
Aspirating Syringes



口腔麻醉注射架
Aspirating Syringes
ZR2117RB
精密, 钩头, 公制/英制, 丝头可换
hook, metric/British



口腔麻醉注射架
Aspirating Syringes
ZR2123RB
精密, 尖头, 公制/英制, 丝头可换
sharp, metric/British



口腔麻醉注射架
Aspirating Syringes
ZR2118RB
精密, 钩头, 公制, 丝头固定
hook, metric

ZR2119RB
精密, 钩头, 英制, 丝头固定
hook, British

ZR2120RB
精密, 尖头, 公制, 丝头固定
sharp, metric

ZR2122RB
精密, 尖头, 英制, 丝头固定
sharp, British

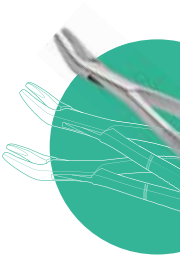

口腔科
Oral Instruments

口腔麻醉注射架(琼脂注射器)
Agar Imrerssion Syringes

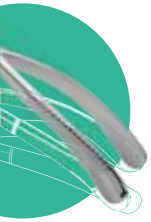

口腔科
Oral Instruments



口腔麻醉注射架(琼脂注射器)
Agar Imrerssion Syringes

ZR2121R
琼脂注射, 2ml

口腔开口器
Mouth Gags



口腔开口器
Mouth Gags

★ZR2130R ★ZR2131R
钳形, 大 钳形, 小
Large Small



口腔开口器
Mouth Gags

ZR2812P
C型, 小号 small



口腔开口器
Mouth Gags

ZR2813P
C型, 中号 medium



口腔开口器
Mouth Gags

ZR2814P
C型, 大号 large



口腔科
Oral Instruments

*本页透明医用塑料产品包装规格为10个/包
10pcs/bag for all the items in this page.

唇颊牵开器、直角拉钩、口角拉钩
Retractors、Retractors、Plastic Corner Retractors



唇颊牵开器
Retractors

★**ZR2140RB**
直, 板式
Straight



唇颊牵开器
Retractors

★**ZR2141RB**
弯, 板式
Curved



直角拉钩 (瓦形拉钩)
Retractors

★**ZR2150RB**
瓦形



直角拉钩
Retractors

★**ZR2151RB**
双头
Double-ended



拉钩
Retractors

ZR2368RB
200×15×35×90°



拉钩
Retractors

ZR2369RB
200×15×40×135°



口角拉钩
Corner Retractors

ZR2570RB
210×40×15, 活动头

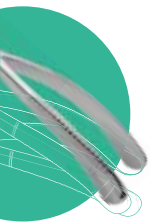

口角拉钩
Plastic Corner Retractors



ZR2804P
T型, 小号, 加厚 small



ZR2805P
T型, 大号, 加厚 large



ZR2806P
Y型, 侧方, 加厚



ZR2807P
唇角, 加厚



ZR2808P
压唇板, 小号 small



ZR2809P
压唇板, 大号 large



ZR2810P
双头, 小号 small

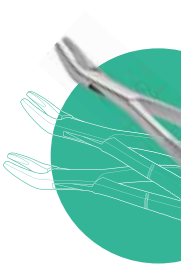

口腔科
Oral Instruments

*本页透明医用塑料产品包装规格为10个/包
10pcs/bag for all the items in this page.

牙用尺, 测量规
Dental Measuring Instruments, Caliper



牙用尺
Dental Measuring Instruments

★ ZR2162RB

测量范围: 0-20, 直头, 分规式 Range:0-20, straight

★ ZR2167RB

测量范围: 0-20, 弯头, 分规式 Range:0-20, curved



牙用尺
Dental Measuring Instruments

ZR2163RB

测量范围:0-120, 牙科垂直距离尺
Range:0-120



牙用尺
Dental Measuring Instruments

ZR2164RB

立体颌平面板



牙用尺
Dental Measuring Instruments

★ ZR2165RB

金属卡尺, 测量范围:0-10
Range:0-10



牙用尺
Dental Measuring Instruments

★ ZR2166RB

游标卡尺, 测量范围:0-100
Range:0-100

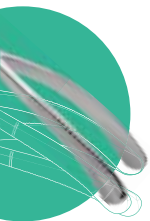

口腔科
Oral Instruments

牙用尺, 测量规
Dental Measuring Instruments, Caliper



牙用尺
Dental Measuring Instruments
ZR2168RB
170mm, 分规式, 对卡头,
测量范围:0-40
Range:0-40



牙用尺
Dental Measuring Instruments
ZR2169RB
180mm, 直头, 测量范围:0-40
Straight, range:0-40



牙用尺
Dental Measuring Instruments
ZR2170RB
180mm, 弯头, 测量范围:0-40
Curved, range:0-40



牙用尺
Dental Measuring Instruments
ZR2171RB
指圈式, 测量范围:0-40
Range:0-40



口腔科
Oral Instruments

牙用尺, 测量规
Dental Measuring Instruments, Caliper



牙用尺
Dental Measuring Instruments
ZR2172RB
种植, 游标卡尺, 测量范围: 0-80
Range: 0-80

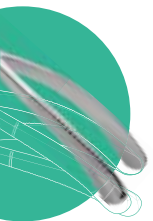

口腔科
Oral Instruments



牙用尺
Dental Measuring Instruments
ZR2173RB
开度测量, 1#

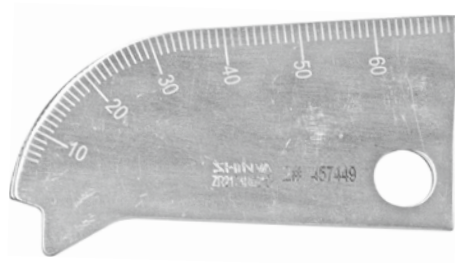

牙用尺
Dental Measuring Instruments
ZR2174RB
开度测量, 2#

上颌窦提升器
Maxillary Sinus Lifter

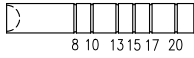

ZR2701RB ■
170×φ2.5, 凹头,
直杆, 带定位套

ZR2702RB ■
170×φ3, 凹头,
直杆, 带定位套

ZR2703RB ■
170×φ3.5, 凹头,
直杆, 带定位套

ZR2704RB ■
170×φ4, 凹头,
直杆, 带定位套

ZR2705RB ■
170×φ4.5, 凹头,
直杆, 带定位套

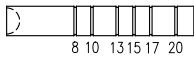

ZR2706RB ■
175×φ2.5, 凹头,
弯杆, 带定位套

ZR2707RB ■
175×φ3, 凹头,
弯杆, 带定位套

ZR2708RB ■
175×φ3.5, 凹头,
弯杆, 带定位套

ZR2709RB ■
175×φ4, 凹头,
弯杆, 带定位套

ZR2710RB ■
175×φ4.5, 凹头,
弯杆, 带定位套

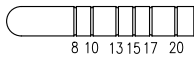

ZR2711RB ■
170×φ2.5, 圆头,
直杆, 带定位套

ZR2712RB ■
170×φ3, 圆头,
直杆, 带定位套

ZR2713RB ■
170×φ3.5, 圆头,
直杆, 带定位套

ZR2714RB ■
170×φ4, 圆头,
直杆, 带定位套

ZR2715RB ■
170×φ4.5, 圆头,
直杆, 带定位套

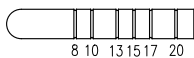

ZR2716RB ■
175×φ2.5, 圆头,
弯杆, 带定位套

ZR2717RB ■
175×φ3, 圆头,
弯杆, 带定位套

ZR2718RB ■
175×φ3.5, 圆头,
弯杆, 带定位套

ZR2719RB ■
175×φ4, 圆头,
弯杆, 带定位套

ZR2720RB ■
175×φ4.5, 圆头,
弯杆, 带定位套



口腔科
Oral Instruments

上颌窦外提升器
 Maxillary Sinus Lifter

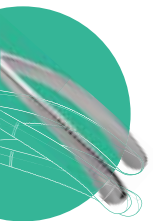

口腔科
 Oral Instruments

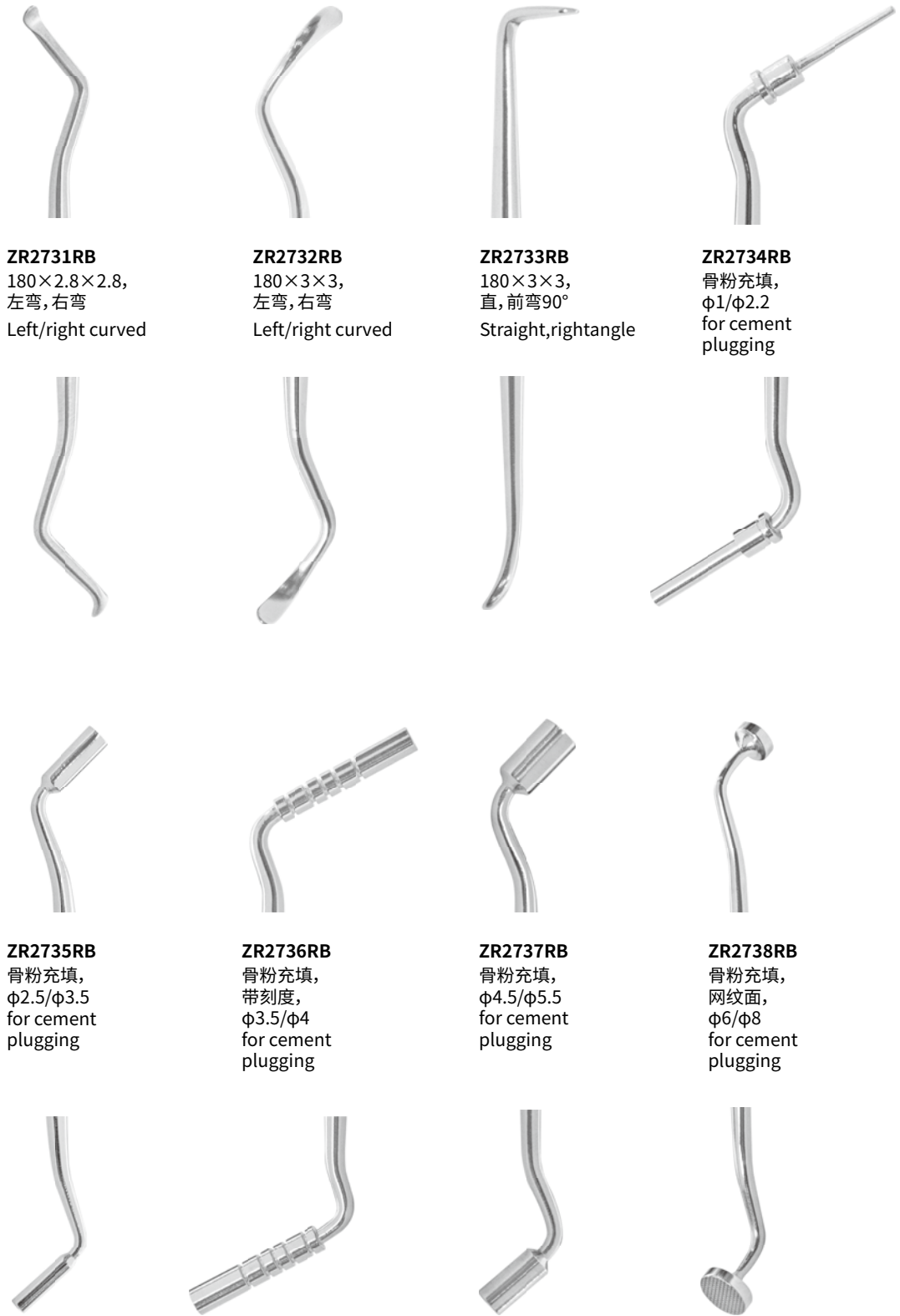

ZR2731RB
 180×2.8×2.8,
 左弯,右弯
 Left/right curved

ZR2732RB
 180×3×3,
 左弯,右弯
 Left/right curved

ZR2733RB
 180×3×3,
 直,前弯90°
 Straight, rightangle

ZR2734RB
 骨粉充填,
 φ1/φ2.2
 for cement
 plugging

ZR2735RB
 骨粉充填,
 φ2.5/φ3.5
 for cement
 plugging

ZR2736RB
 骨粉充填,
 带刻度,
 φ3.5/φ4
 for cement
 plugging

ZR2737RB
 骨粉充填,
 φ4.5/φ5.5
 for cement
 plugging

ZR2738RB
 骨粉充填,
 网纹面,
 φ6/φ8
 for cement
 plugging

正畸托槽定位器
Orthodontic Bracket Positioner



ZR2216RB
杆式, 105mm,
2/3.5, 2.5/3

ZR2217RB
杆式, 105mm,
4/4.5, 3.5/5

ZR2218RB
杆式, 105mm,
4/6, 4.5/5



ZR2219RB
杆式, 活动, 140mm,
3.5/5, 4/4.5



ZR2212RB
星形, 前牙用
for front teeth

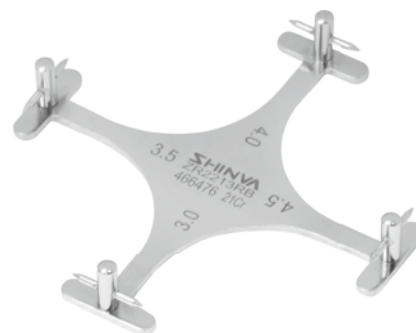

ZR2213RB
星形, 后牙用
for back teeth



口腔科
Oral Instruments

托槽夹持镊
Bracket Holding Forceps



ZR1492RB
125, 颊面管



ZR1493RB
140

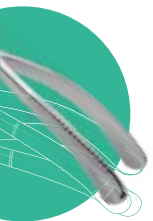

口腔科
Oral Instruments

自锁托槽开启工具
Self-locking Bracket
Opening tools



ZR2208RB
140, 整体盖板



ZR2209RB
145, 孔式盖板



手术刀柄
Scalpel Handles



ZR2564RBs
170, 直型



ZR2566RB
150, 上弯, 圆柄



ZR2567RB
160, 角度可调, 圆柄



ZR2563RN
140, 直型, 圆柄, 显微

ZR2563T
140, 直型, 圆柄, 显微



牙龈刀
Gum Knives

ZR932R
25×3.5, 桃形, 双面刃 (配合ZR2563RN/T使用)



口腔科
Oral Instruments

硅橡胶修形器
 Silicone Rubber Trimmers



硅橡胶修形器
 Carver For Silicone
ZR2214RB
 双头, 弯



硅橡胶修形器
 Carver For Silicone
 ★**ZR2215R**
 S2雕刀型



牙科用锉
 Root Canal File Handles



ZR2197RB
 160, 夹持手柄

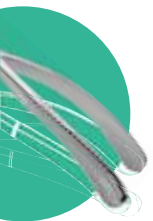

口腔科
 Oral Instruments

牙周锉
 Periodontal Files



ZR1510RB
 180, 双头, 弯, 圆柄

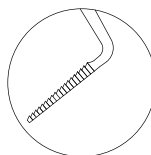
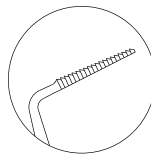

ZR1510R
 160, 双头, 弯, 六角柄

压舌板
Tongue-spatula



压舌板
Tongue-spatula

★ZR2175R
140, 直形
Straight



压舌板
Tongue-spatula

★ZR2176R
160, 直形
Straight



压舌板
Tongue-spatula

★ZR2177R
180, 直形
Straight



压舌板
Tongue-spatula

ZR2180RB
38, 角型



口腔科
Oral Instruments

吸唾管、拔髓针(拔髓针柄)
Aspirator Tip、Nerve Broach



拔髓针(拔髓针柄)
Nerve Broach

★ **ZR2191R**
神经针柄, 110



吸唾管
Aspirator Tip

★ **ZR2192R** ★ **ZR2190R**
Φ2 Φ3

★ **ZR2194R** ★ **ZR2188R**
Φ4 Φ5



吸唾管
Aspirator Tip

★ **ZR2189R**
Φ3.5, 带孔



吸唾管
Aspirator Tip

★ **ZR2193R**
170×Φ3.5, 锥度, 圆柄

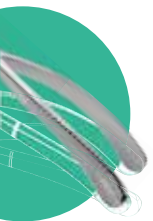

口腔科
Oral Instruments

橡皮障打孔器、方丝弓成型器、牙正畸结扎器(带环推子)、牙正畸结扎器(结扎杆)
Rubber Dam Punch Forceps, Arch Turret, Band Pusher, Ligation rod



橡皮障打孔器
Rubber Dam Punch Forceps

★ZR2196R
165



方丝弓成型器
Arch Turret

★ZR2200R
7槽, 0°



牙正畸结扎器(带环推子)
Band Pusher

★ZR2210R
带环推子, 空心, 六角柄



牙正畸结扎器
(结扎杆)
Ligation rod
★ZR2211R
双头
Double-ended

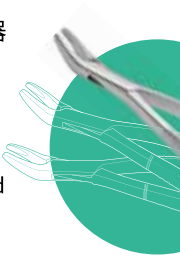

口腔科
Oral Instruments

玻璃粘固粉调板、橡皮碗、滴蜡器
Rubber Cap、Wax Drip

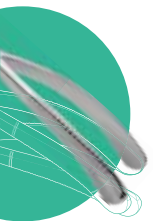

口腔科
Oral Instruments



滴蜡器
Wax Drip



★ZR2231R
1#



ZR2232R
2#



ZR2233R
3#



玻璃粘固粉调板

★ZR2220
两片装



橡皮碗
Rubber Cap

★ZR2226P
大号
Large



橡皮碗
Rubber Cap

★ZR2228P
小号
Small

去冠器、去冠器(去冠钳)、去冠器(金冠破除钳)
Crown Remover、Crown Remove Pliers



去冠器
Crown Remover

★ZR2241R
一柄二头



去冠器
Crown Remover

★ZR2242R
自动去冠器, 双头



去冠器(去冠钳)
Crown Remover

ZR2243R
去冠钳, 钳型



去冠器(金冠破除钳)
Crown Remove Pliers

ZR2244R
金冠破除



口腔科
Oral Instruments

成形片、成形片夹
Matrix Band、Matrix Clamp



成形片
Matrix Band

★ZR2255R
小号
Small

★ZR2256R
中号
Middle

★ZR2257R
大号
Large

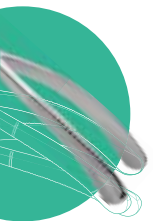

口腔科
Oral Instruments



成形片夹
Matrix Clamp

★ZR2270RB
钳式



成形片夹
Matrix Clamp

ZR2271RB
杆式

成形片夹(结扎丝)、成形片夹(牙用不锈钢丝)、成形片夹(牙用不锈钢扁丝)
Ligtire Wire、Dental Stainless Steel Wire



成形片夹(结扎丝)
Ligtire Wire

- ★ZR2276R
结扎丝 Φ 0.2 20g
- ★ZR2277R
结扎丝 Φ 0.3 20g
- ★ZR2278R
结扎丝 Φ 0.4 20g
- ★ZR2279R
结扎丝 Φ 0.25 20g



成形片夹(牙用不锈钢丝)
Dental Stainless Steel Wire

- ZR2280R
牙用不锈钢丝 Φ 0.5 30g
- ZR2281R
牙用不锈钢丝 Φ 0.6 30g
- ZR2282R
牙用不锈钢丝 Φ 0.7 30g
- ZR2283R
牙用不锈钢丝 Φ 0.8 30g
- ZR2284R
牙用不锈钢丝 Φ 0.9 30g
- ZR2285R
牙用不锈钢丝 Φ 1.2 30g
- ZR2286R
牙用不锈钢丝 Φ 1.4 30g
- ZR2287R
牙用不锈钢丝 Φ 1.6 30g
- ZR2288R
牙用不锈钢丝 Φ 1.8 30g

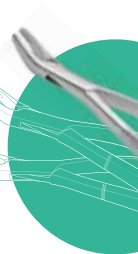

口腔科
Oral Instruments



成形片夹(牙用不锈钢丝)
Dental Stainless Steel Wire

- ★ZR2289R
牙用不锈钢丝 Φ 0.5 50g
- ★ZR2290R
牙用不锈钢丝 Φ 0.6 50g
- ★ZR2291R
牙用不锈钢丝 Φ 0.7 50g
- ★ZR2292R
牙用不锈钢丝 Φ 0.8 50g
- ★ZR2293R
牙用不锈钢丝 Φ 0.9 50g
- ★ZR2294R
牙用不锈钢丝 Φ 1.0 50g



成形片夹(牙用不锈钢扁丝)
Dental Stainless Steel Wire

- ZR2295R
牙用不锈钢扁丝 大 1.6
Large
- ZR2296R
牙用不锈钢扁丝 中 1.4
Middle
- ZR2297R
牙用不锈钢扁丝 小 1.2
Small

牙科夹(牙托)
Impression Tray



牙科夹(不锈钢有孔牙托)
Impression Tray

- ★**ZR2344RB**
牙托, 小, 上下口, 有孔, 不锈钢
Small
- ★**ZR2345RB**
牙托, 中, 上下口, 有孔, 不锈钢
Middle
- ★**ZR2346RB**
牙托, 大, 上下口, 有孔, 不锈钢
Large



牙科夹(不锈钢有孔局部牙托)
Impression Tray

- ★**ZR2347RB**
牙托, 左右, 局部, 有孔, 不锈钢



牙科夹(不锈钢有孔局部牙托)
Impression Tray

- ★**ZR2348RB**
牙托, 前牙, 上下口, 局部, 有孔, 不锈钢



牙科夹(不锈钢有孔活动牙托)
Impression Tray

- ★**ZR2349RB**
牙托, 活动式, 有孔, 不锈钢



牙科夹(不锈钢无孔牙托)
Impression Tray

- ZR2350RB**
牙托, 小, 上下口, 无孔, 不锈钢
Small
- ZR2351RB**
牙托, 中, 上下口, 无孔, 不锈钢
Middle
- ZR2352RB**
牙托, 大, 上下口, 无孔, 不锈钢
Large

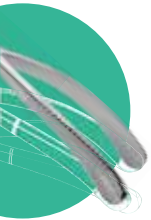

牙科夹(牙托)
Impression Tray



牙科夹(不锈钢无孔局部牙托)
Impression Tray

ZR2353RB
牙托, 左右, 局部, 无孔, 不锈钢



牙科夹(不锈钢无孔局部牙托)
Impression Tray

ZR2354RB
牙托, 前牙, 上下口, 不锈钢



牙科夹(不锈钢无孔活动牙托)
Impression Tray

ZR2355RB
牙托, 活动式, 不锈钢



牙科夹(不锈钢有孔无牙牙托)
Impression Tray

ZR2356RB
牙托, 无牙, 小, 上下口, 不锈钢
Small

ZR2357RB
牙托, 无牙, 中, 上下口, 不锈钢
Middle

ZR2358RB
牙托, 无牙, 大, 上下口, 不锈钢
Large



牙科夹(不锈钢无孔无牙牙托)
Impression Tray

ZR2359RB
牙托, 无牙, 小, 上下口, 不锈钢
Small

ZR2360RB
牙托, 无牙, 中, 上下口, 不锈钢
Middle

ZR2361RB
牙托, 无牙, 大, 上下口, 不锈钢
Large



口腔科
Oral Instruments

牙科夹(牙托梗 舌杆)、牙科夹(牙托梗 腭杆)、消毒盒
Lingual Bars, Palatal Bars, Sterilization Trays



牙科夹(牙托梗 腭杆)
Palatal Bars

- ZR2362R**
牙托梗, 46, 上口, 大, 1×20
Large
- ZR2363R**
牙托梗, 43, 上口, 中, 1×20
Middle
- ZR2364R**
牙托梗, 40, 上口, 小, 1×20
Small



牙科夹(牙托梗 舌杆)
Lingual Bars

- ZR2365R**
牙托梗, 48, 下口, 大, 1×20
Large
- ZR2366R**
牙托梗, 43, 下口, 中, 1×20
Middle
- ZR2367R**
牙托梗, 38, 下口, 小, 1×20
Small



口腔科
Oral Instruments



消毒盒
Sterilization Trays

★**ZR3001R** 205×67×23,5×1



消毒盒
Sterilization Trays

★**ZR3004R** 205×122×23,10×1



医用检查灯
Medical examination light

ZR2800P
可调试

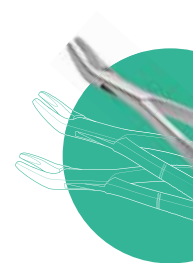

口腔科
 Oral Instruments

WCT-I 型微创牙挺器械包 (ZR1360)
 WCT-I MIS Elevators Instrument Set

序号	编 码	名 称	规 格	单 位	数 量
1	ZR1361RB	微创牙挺	1#,2mm, 直刃	把	1
2	ZR1362RB	微创牙挺	2#,3mm, 弯刃	把	1
3	ZR1363RB	微创牙挺	3#,3mm, 直刃	把	1
4	ZR1364RB	微创牙挺	4#, 3mm, 反向弯曲	把	1
5	ZR1365RB	微创牙挺	5#, 3mm, 反角弯曲	把	1
6	ZR1366RB	微创牙挺	6#,5mm, 弯刃	把	1
7	ZR1367RB	微创牙挺	7#,5mm, 直刃	把	1
8	ZR1368RB	微创牙挺	8#,3/1.5mm, 直双刃	把	1
9	ZR1369RB	微创牙挺	9#,5/3mm, 直双刃	把	1

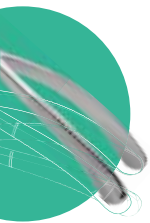

口腔科
Oral Instruments

HKJ-I型 微创拔牙器械包 (ZR1005)
HKJ-I Type Minimally Invasive Tooth Extraction Instrument Set

序号	编 码	名 称	规 格	单 位	数 量
1	ZR2140RB	唇颊牵开器	直, 板式	个	1
2	ZR2184RB	外科吸引器	150×Φ4, 带孔, 锥度, 防堵, 圆柄	支	1
3	ZR1551RB	牙龈分离保护器	175, 牙龈分离, 牙龈保护, 骨膜分离	把	1
4	ZR1395RB	微创根挺	3mm, 弯, 楔入, 剥离, 旋转	把	1
5	ZR1396RB	微创根挺	4mm, 弯, 楔入, 剥离, 旋转	把	1
6	ZR1183RB	微创旋转式残根钳	楔入, 环抱, 左右通用, 防滑, 上颌牙根	把	1
7	ZR1181RB	微创旋转式磨牙钳	楔入, 环抱, 上颌, 左右通用, 防滑	把	1
8	ZR1182RB	微创旋转式磨牙钳	楔入, 环抱, 下颌, 左右通用, 防滑	把	1
9	ZR1184RB	微创旋转式残根钳	楔入, 环抱, 左右通用, 防滑, 下颌牙根	把	1

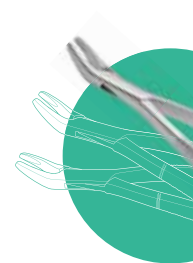

口腔科
Oral Instruments

HKJ- II 型 微创拔牙器械包 (ZR1006)
HKJ- II Type Minimally Invasive Tooth Extraction Instrument Set

序号	编 码	名 称	规 格	单 位	数 量
1	ZR2140RBh	唇颊牵开器	直, 板式, 黑金刚	个	1
2	ZR2184RBh	外科吸引器	150×Φ4, 黑金刚, 带孔, 锥度, 防堵, 圆柄	支	1
3	ZR1551RBh	牙龈分离保护器	175, 黑金刚, 牙龈分离, 牙龈保护, 骨膜分离	把	1
4	ZR1396RBh	微创根挺	4mm, 黑金刚, 弯, 楔入, 剥离, 旋转	把	1
5	ZR1395RBh	微创根挺	3mm, 黑金刚, 弯, 楔入, 剥离, 旋转	把	1
6	ZR1183RBh	微创旋转式残根钳	黑金刚, 楔入, 环抱, 左右通用, 防滑, 上颌牙根	把	1
7	ZR1182RBh	微创旋转式磨牙钳	黑金刚, 楔入, 环抱, 下颌, 左右通用, 防滑	把	1
8	ZR1184RBh	微创旋转式残根钳	黑金刚, 楔入, 环抱, 左右通用, 防滑, 下颌牙根	把	1
9	ZR1181RBh	微创旋转式磨牙钳	黑金刚, 楔入, 环抱, 上颌, 左右通用, 防滑	把	1



★KBY-I型拔牙手术器械包 编码:ZR1001
KBY-I tooth extraction surgical instruments set

序号	编 码	名 称	规 格	单 位	数 量
1	ZR1101RB	拔牙钳	1#, 成人, 镶鳃式	把	1
2	ZR1107RB	拔牙钳	17#, 成人, 镶鳃式	把	1
3	ZR1108RB	拔牙钳	18L#, 成人, 镶鳃式	把	1
4	ZR1109RB	拔牙钳	18R#, 成人, 镶鳃式	把	1
5	ZR1138RB	拔牙钳	65#, 成人, 镶鳃式	把	1
6	ZR1150RB	拔牙钳	150#, 成人, 镶鳃式	把	1
7	ZR021R	牙用镊	160 双弯	把	1
8	ZR1694RB	牙骨凿	4# 直刃 宽5	把	1
9	ZR2139R	牙骨锤	160, 尼龙	把	1
10	ZR1941RB	牙探针	双头 常规 5#	根	1
11	ZR1371RB	牙挺	1# 直头 宽2.5	支	1
12	ZR1372RB	牙挺	2# 直头 宽3	支	1
13	ZR1373RB	牙挺	3# 直头 宽4	支	1
14	ZR1781R	牙刮匙	1# 双弯铲形 锐 双头	支	1
15	ZR1525R	口镜	口镜柄	支	1
16	ZR1520R	口镜	4# 平光 耐高温	个	1
17	ZR1521R	口镜	4# 放大 耐高温	个	1

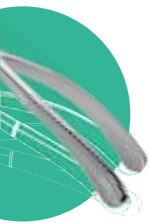



★ YZB-I型牙周病手术器械包 编码:ZR1002
YZB-I periodontal disease surgical instruments set

序号	编码	名称	规格	单位	数量
1	ZR1831RB	刮治器	1#-2# 双头 实心圆柄	支	1
2	ZR1832RB	刮治器	3#-4# 双头 实心圆柄	支	1
3	ZR1833RB	刮治器	5#-6# 双头 实心圆柄	支	1
4	ZR1834RB	刮治器	7#-8# 双头 实心圆柄	支	1
5	ZR1835RB	刮治器	9#-10# 双头 实心圆柄	支	1
6	ZR1836RB	刮治器	11#-12# 双头 实心圆柄	支	1
7	ZR1837RB	刮治器	13#-14# 双头 实心圆柄	支	1
8	ZR1838RB	刮治器	15#-16# 双头 实心圆柄	支	1
9	ZR1839RB	刮治器	17#-18# 双头 实心圆柄	支	1



口腔科
Oral Instruments



KZD-I型口腔诊断器械包 编码:ZR1010
KZD-I Oral Diagnostic Instrument set

序号	编码	名称	规格	单位	数量
1	ZR023R	牙用镊	160, 双弯, 有定位	把	1
2	ZR1941RB	牙探针	双头, 常规, 5#	支	1
3	ZR1520R	口镜	4# 平光 耐高温	个	1
4	ZR1525R	口镜	口镜柄	个	1
5	ZR3001R	消毒盒	205×67×23, 5×1	个	1



ZZJ- II 型牙科种植手术基础器械包 编码:ZR1004
 ZZJ-II Dental Implant Surgery Basic Instrument set

序号	编 码	名 称	规 格	单 位	数 量
1	ZM033R	持针钳	160,直,细针,镶片0.3	把	1
2	ZH145R	止血钳	140,弯,全齿	把	5
3	ZH445R	止血钳	180,弯,全齿	把	1
4	ZE432R	帕巾钳	110,尖头	把	6
5	ZR2140RB	唇颊牵开器	直,板式	个	1
6	ZR2141RB	唇颊牵开器	弯,板式	个	1
7	ZR1520R	口镜	4# 平光 耐高温	个	1
8	ZR1525R	口镜	口镜柄	个	1
9	ZR1515R	口镜	反光板式,双面	个	1
10	ZO529RN	鼻腔吸引管	150×Φ4×12	支	1
11	ZO735R	鼻腔吸引管	160×Φ4×24,弯	支	1
12	ZR1541R	牙用分离器	牙骨膜分离 1# 双头	把	1
13	ZR1542R	牙用分离器	牙骨膜分离 2# 双头	把	1
14	ZB077R	手术刀柄	7#	把	1
15	ZK043R	牙骨锤	180	个	1

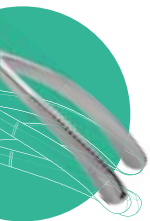



YCT-I牙科树脂充填器械包 编码:ZR1016
YCT-I Dental Resin Filling Instrument set

序号	编码	名称	规格	单位	数量
1	ZR2651RB	牙科树脂充填器	树脂充填,测量/充填,空心圆柄	支	1
2	ZR2652RB	牙科树脂充填器	树脂充填,探针/造型,空心圆柄	支	1
3	ZR2653RB	牙科树脂充填器	树脂充填,精细充填/造型,空心圆柄	支	1
4	ZR2654RB	牙科树脂充填器	树脂充填,充填/研光,空心圆柄	支	1
5	ZR2655RB	牙科树脂充填器	树脂修正,空心圆柄	支	1



★ YCT- II 牙科树脂充填器械包 编码:ZR1017
YCT-I Dental Resin Filling Instrument set

序号	编码	名称	规格	单位	数量
1	ZR2651RNh	牙科树脂充填器	树脂充填,测量/充填,空心圆柄	支	1
2	ZR2652RNh	牙科树脂充填器	树脂充填,探针/造型,空心圆柄	支	1
3	ZR2653RNh	牙科树脂充填器	树脂充填,精细充填/造型,空心圆柄	支	1
4	ZR2654RNh	牙科树脂充填器	树脂充填,充填/研光,空心圆柄	支	1
5	ZR2655RNh	牙科树脂充填器	树脂修正,空心圆柄	支	1

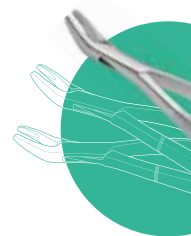

口腔科
Oral Instruments

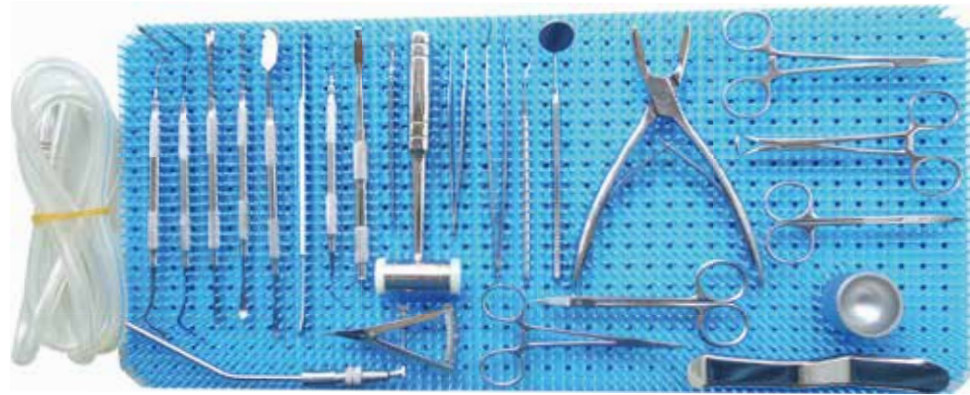

ZZ-I型牙科种植手术器械包 (ZR1011)
ZZ-I Dental Implant Instrument Set

序号	编码	名称	规格	单位	数量
1	ZB073RN	手术刀柄	3#	把	1
2	ZH110RB	止血钳	125, 直纹, 全齿	把	1
3	ZM240RB	持针钳	140, 直, 细针	把	1
4	ZE432RB	帕巾钳	110, 尖头	把	1
5	ZR1451RB	牙龈剪	130, 弯	把	1
6	ZR1452RB	牙龈剪	双弯	把	1
7	ZR1310RB	牙槽咬骨钳	圆口	把	1
8	ZR2139R	牙骨锤	150	把	1
9	ZR2141RB	唇颊牵开器	弯, 板式	个	1
10	ZR2188R	吸唾管	φ5	支	1
11	ZR023R	牙用镊	160, 双弯, 有定位	把	1
12	ZR1520R	口镜	4#, 平光, 耐高温	个	1
13	ZR1525R	口镜	口镜柄	支	1
14	ZR2001RB	牙周袋探针	扁刻, (1-10)	根	1
15	ZR1837RBs	刮治器	13#-14#, 双头, 硅胶柄	支	1
16	ZD684RN	整形镊	120×1, 直, 有齿	把	1
17	ZR2187R	吸引管	带硅胶管	个	1
18	ZR2550RN	置骨器	30×φ40	个	1
19	ZR2167RB	牙用尺	测量范围: 0-20, 弯头, 分规式	把	1
20	ZR2560RB	牙骨凿	2#, 160, 牙周, 双面刃	把	1
21	ZR1794RB	牙刮匙	185, 3.5, 双弯铲形, 锐, 双头	支	1
22	ZR1793RB	牙刮匙	185, 2.5, 双弯铲形, 锐, 双头	支	1
23	ZR2520RB	骨膜剥离器	190, 宽6/4, 圆头/平刃, 牙用	把	1
24	ZR2521RB	骨膜剥离器	200, 宽5/8, 双头, 圆柄, 牙用	把	1
25	ZR2509RB	骨膜剥离器	190, 圆头, 铲形, 圆柄	把	1
26	ZR2523RB	骨膜剥离器	双头, 200×11, 锐口, 200×12, 钝口, 牙用	把	1

备注: ZR1011随包赠送消毒包布, 如需配专用不锈钢消毒盒可选购ZR3008R。

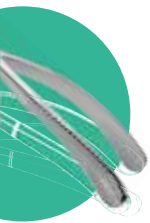

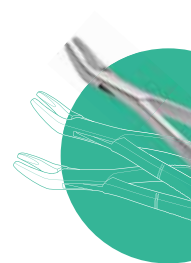

YZB-III 型牙周病手术器械包(ZR1014)
 YZB-III Periodontal Disease Surgical Instruments Set

序号	编 码	名 称	规 格	单 位	数 量
1	ZR1831RBs	刮治器	1#-2#, 双头, 硅胶柄	支	1
2	ZR1832RBs	刮治器	3#-4#, 双头, 硅胶柄	支	1
3	ZR1833RBs	刮治器	5#-6#, 双头, 硅胶柄	支	1
4	ZR1834RBs	刮治器	7#-8#, 双头, 硅胶柄	支	1
5	ZR1835RBs	刮治器	9#-10#, 双头, 硅胶柄	支	1
6	ZR1836RBs	刮治器	11#-12#, 双头, 硅胶柄	支	1
7	ZR1837RBs	刮治器	13#-14#, 双头, 硅胶柄	支	1
8	ZR1838RBs	刮治器	15#-16#, 双头, 硅胶柄	支	1
9	ZR1839RBs	刮治器	17#-18#, 双头, 硅胶柄	支	1

口腔科
 Oral Instruments



YCT-III 型牙科树脂充填器械包 (ZR1018)
YCT-III Dental Resin Filling Instrument Set

序号	编 码	名 称	规 格	数量
1	ZR2651RBs	牙科树脂充填器	树脂充填, 测量/充填, 硅胶柄	支 1
2	ZR2652RBs	牙科树脂充填器	树脂充填, 探针/造型, 硅胶柄	支 1
3	ZR2653RBs	牙科树脂充填器	树脂充填, 精细充填/造型, 硅胶柄	支 1
4	ZR2654RBs	牙科树脂充填器	树脂充填, 充填/研光, 硅胶柄	支 1
5	ZR2655RBs	牙科树脂充填器	树脂修正, 硅胶柄	支 1

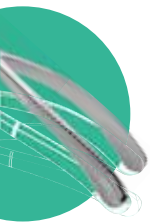



YCX 型牙槽骨修整及拔牙手术套装 (ZR1031)
YCX Type Alveolar Bone Treatment And Extraction Instruments Set

序号	编 码	名 称	规 格	单 位	数 量
1	ZR1525R	口镜	口镜柄	支	1
2	ZR1522R	口镜	5#, 平光, 耐高温	个	1
3	ZR2007RB	牙周袋探针	160mm, 圆柄 (1-15)	根	1
4	ZR2190R	吸唾管	Φ3	支	1
5	ZR2140RB	唇颊牵开器	直, 板式	个	1
6	ZR2564RBs	手术刀柄	170, 直型	把	1
7	ZR2523RB	骨膜剥离器	双头, 200×11, 锐口, 200×12, 钝口, 牙用	把	1
8	ZR2511RB	骨膜剥离器	180, 宽 4/6, 圆柄	把	1
9	ZR1694RB	牙骨凿	4#, 直, 双面刃, 宽 5	把	1
10	ZR2139R	牙骨锤	150	把	1
11	ZR1511R	牙骨锉	1#, 尖圆 / 尖圆	把	1
12	ZC049RN	精细手术剪	125, 直尖, 解剖型	把	1
13	ZM016R	持针钳	140, 直, 细针, 镶片 0.3	把	1
14	ZR1310RB	牙槽咬骨钳	圆口	把	1
15	ZD555RB	组织镊	125, 1×2 钩	把	1

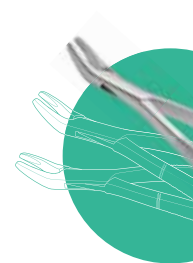



YTX 型牙体修复套装 (ZR1032)
YTX Type Dental Restoration Set

序号	编 码	名 称	规 格	单 位	数 量
1	ZR1525R	口镜	口镜柄	支	1
2	ZR1522R	口镜	5#, 平光, 耐高温	个	1
3	ZR022R	牙用镊	160, 单弯, 有定位	把	1
4	ZR1941RB	牙探针	5#	根	1
5	ZR1873R	剔挖器	3#	支	1
6	ZR1872R	剔挖器	2#	支	1
7	ZR2105RB	牙科树脂充填器	树脂修正	支	1

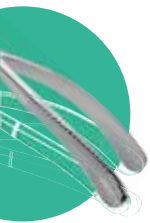



YZF 型牙周翻瓣术套装 (ZR1033)
YZF Periodontal Flap Surgery Set

序号	编 码	名 称	规 格	单 位	数 量
1	ZR1525R	口镜	口镜柄	支	1
2	ZR1522R	口镜	5#, 平光, 耐高温	个	1
3	ZR2007RB	牙周袋探针	(1-15)	根	1
4	ZR2564RBs	手术刀柄	170, 直型	把	1
5	ZM236R	持针钳	180, 直, 粗针	把	1
6	ZB512	手术刀片	12#	包	1
7	ZB515	手术刀片	15#	包	1
8	ZR2511RB	骨膜剥离器	180, 宽 4/6, 圆柄	把	1
9	ZR2641RB	骨刮匙	180×3×5, 直头, 弯头	把	1
10	ZR1831RB	刮治器	1#-2#, 双头, 实心圆柄	支	1
11	ZR1834RB	刮治器	7#-8#, 双头, 实心圆柄	支	1
12	ZR1836RB	刮治器	11#-12#, 双头, 实心圆柄	支	1
13	ZR1837RB	刮治器	13#-14#, 双头, 实心圆柄	支	1
14	ZR1832RB	刮治器	3#-4#, 双头, 实心圆柄	支	1
15	ZC911RB	精细手术剪	140, 弯尖, 小血管	把	1
16	ZR022R	牙用镊	160, 单弯, 有定位	把	1
17	ZF2619RB	显微持针钳	140×0.4, 自锁, 弯型	把	1
18	ZR2190R	吸唾管	Φ3	支	1
19	ZR1723R	牙刮匙	3#, 双弯铲形, 双头	支	1

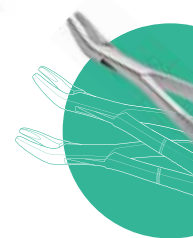

口腔科
Oral Instruments

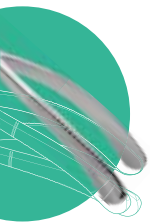

口腔科
Oral Instruments

YZY 型牙周冠延长手术套装 (ZR1034)
YZY Type Periodontal Crown Extension Surgery Set

序号	编 码	名 称	规 格	单 位	数 量
1	ZR1522R	口镜	5#, 平光, 耐高温	个	1
2	ZR1525R	口镜	口镜柄	支	1
3	ZR2005RB	牙周袋探针	(1-2-3-5-7-8-9-10)	根	1
4	ZR2564RBs	手术刀柄	170, 直型	把	1
5	ZR2511RB	骨膜剥离器	180, 宽 4/6, 圆柄	把	1
6	ZR2641RB	骨刮匙	180×3×5, 直头, 弯头	把	1
7	ZR1851R	洁治器	1#, 单头	支	1
8	ZR1831RB	刮治器	1#-2#, 双头, 实心圆柄	支	1
9	ZC444R	精细手术剪	140, 弯尖	把	1
10	ZR022R	牙用镊	160, 单弯, 有定位	把	1
11	ZF2619RB	显微持针钳	140×0.4, 自锁, 弯型	把	1
12	ZR2001RB	牙周袋探针	扁刻, (1-10)	根	1



XYZ 型显微牙周手术套装 (ZR1035)
XYZ Type Micro Periodontal Surgery Set

序号	编 码	名 称	规 格	单 位	数 量
1	ZR2565RN	手术刀柄	140, 直型, 圆柄	把	1
2	ZF017RN	显微剪	160, 弯型, 簧式	把	1
3	ZR022R	牙用镊	160, 单弯, 有定位	把	1
4	ZF2618RB	显微持针钳	140×0.4, 自锁, 直型	把	1
5	ZF2624RB	显微持针钳	180×0.4, 自锁, 直型	把	1
6	ZD772RG	显微镊	185×0.4, 弯型, 平台, 圆柄	把	1

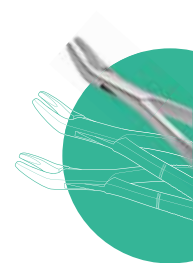

口腔科
Oral Instruments

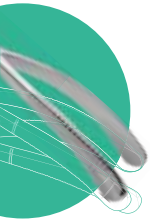

口腔科
Oral Instruments

YYQ 型牙龈切除术套装 (ZR1036)
YYQ Type Gingivectomy Set

序号	编 码	名 称	规 格	单 位	数 量
1	ZR2007RB	牙周袋探针	(1-15)	根	1
2	ZR022R	牙用镊	160, 单弯, 有定位	把	1
3	ZR1571R	牙龈刀	1#, 切除, 斧刃左	把	1
4	ZR1572R	牙龈刀	2#, 切除, 斧刃右	把	1

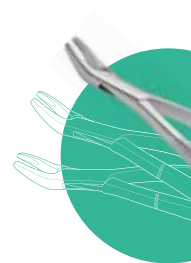

口腔科
 Oral Instruments

WCX 型外科拆线套装 (ZR1037)
 WCX Type Surgical Suture Removal Set

序号	编 码	名 称	规 格	单 位	数 量
1	ZR1525R	口镜	口镜柄	支	1
2	ZR1522R	口镜	5#, 平光, 耐高温	个	1
3	ZR1941RB	牙探针	双头, 常规, 5#	根	1
4	ZR1837RB	刮治器	13#-14#, 双头, 实心圆柄	支	1
5	ZD243RN	胸腔镊	200, 弯无钩	把	1
6	ZC804RB	拆线剪	140×40	把	1



口腔科
Oral Instruments

GGZ 型根管治疗套装 (ZR1038)
GGZ Type Root Canal Treatment Set

序号	编 码	名 称	规 格	单 位	数 量
1	ZR1525R	口镜	口镜柄	支	1
2	ZR1522R	口镜	5#, 平光, 耐高温	个	1
3	ZR1942RB	牙探针	双头, DG16#	根	1
4	ZR022R	牙用镊	160, 单弯, 有定位	把	1
5	ZR2034R	根管充填器	1#/3#, 垂直加压, 双头, 0.35, 0.45	支	1
6	ZR2035R	根管充填器	5#/7#, 垂直加压, 双头, 0.5, 0.75	支	1
7	ZR2033R	根管充填器	3#, 垂直加压, 单头, 1.0	支	1
8	ZR2041R	根管充填器	1#, 侧压, 单头, 0.3	支	1
9	ZR2100R	牙科树脂充填器	树脂修正	支	1

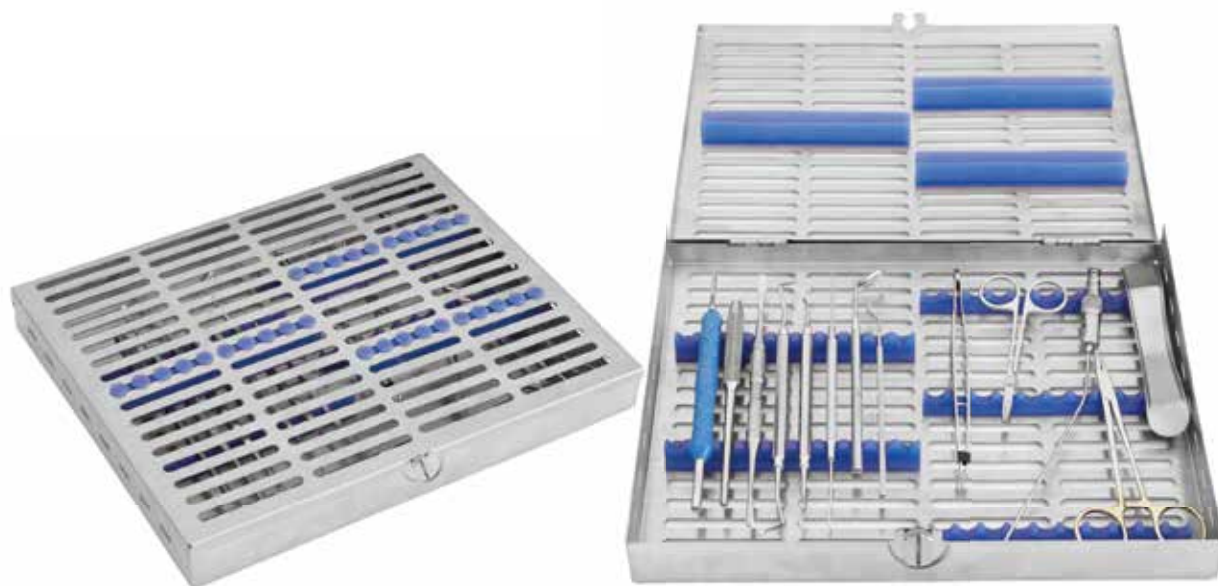

XGJ- I型显微根尖手术套装 (ZR1039)
XGJ- I Type Microscopic Apical Surgery Set

序号	编 码	名 称	规 格	单 位	数 量
1	ZR1525R	口镜	口镜柄	支	1
2	ZR1520R	口镜	4#, 平光, 耐高温	个	1
3	ZR1951RB	牙探针	双头, 1#	根	1
4	ZR2007RB	牙周袋探针	(1-15)	根	1
5	ZR2564RBs	手术刀柄	170, 直型	把	1
6	ZR2511RB	骨膜剥离器	180, 宽 4/6, 圆柄	把	1
7	ZR1722R	牙刮匙	2#, 双弯铲形, 双头	支	1
8	ZR2565RN	手术刀柄	140, 直型, 圆柄	把	1
9	ZR1913R	研光器	1.5#, 2#, 双头	支	1
10	ZC121R	手术剪	115, 弯尖	把	1
11	ZM016R	持针钳	140, 直, 细针, 镶片 0.3	把	1
12	ZR2140RB	唇颊牵开器	直, 板式	个	1
13	ZR2192R	吸唾管	φ2	支	1
14	ZR022R	牙用镊	155mm, 缝合	把	1

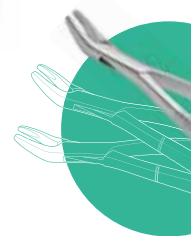

口腔科
Oral Instruments



XGJ- II 型显微根尖手术套装 (ZR1040)
XGJ- II Type Microscopic Apical Surgery Set

序号	编 码	名 称	规 格	单 位	数 量
1	ZR1525R	口镜	口镜柄	支	1
2	ZR1520R	口镜	4#, 平光, 耐高温	个	1
3	ZR1951RB	牙探针	双头, 1#	根	1
4	ZR1942RB	牙探针	双头, DG16#	根	1
5	ZR2565RN	手术刀柄	140, 直型, 圆柄	把	1
6	ZR1872R	剔挖器	2#, 双弯, 双头	支	1
7	ZR1875R	剔挖器	5#, 双弯, 双头	支	1
8	ZR1876R	剔挖器	6#, 双弯, 双头	支	1
9	ZR1722R	牙刮匙	2#, 双弯铲形, 双头	支	1
10	ZR1913R	研光器	1.5#, 2#, 双头	支	1
11	ZR2064R	粘固粉充填器	4#, 双头	支	1
12	ZR2564RBs	手术刀柄	170, 直型	把	1
13	ZR2511RB	骨膜剥离器	180, 宽 4/6, 圆柄	把	1
14	ZD771RG	显微镊	185×0.4, 直型, 平台, 圆柄	把	1
15	ZR022R	牙用镊	155mm, 缝合	把	1
16	ZF2670RB	显微组织剪	180, 弯型, 带齿, 簧式, 圆柄	把	1
17	ZC803RB	拆线剪	140×28	把	1
18	ZR2192R	吸唾管	φ2	支	1
19	ZR2140RB	唇颊牵开器	直, 板式	个	1

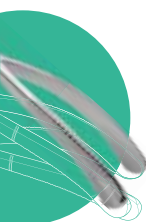



ZZJ- VI 型牙科种植手术基础器械套装 (ZR1041)
ZZJ-VI Type Dental implant Surgery Basic Instrument Set

序号	编 码	名 称	规 格	单 位	数 量
1	ZR1525R	口镜	口镜柄	支	1
2	ZR1522R	口镜	5#, 平光, 耐高温	个	1
3	ZR2007RB	牙周袋探针	(1-15)	根	1
4	ZR2190R	吸唾管	Φ3	支	1
5	ZR2140RB	唇颊牵开器	直, 板式	个	1
6	ZR2564RBs	手术刀柄	170, 直型	把	1
7	ZR2511RB	骨膜剥离器	180, 宽 4/6, 圆柄	把	1
8	ZR2509RB	骨膜剥离器	190, 圆头, 铲形, 圆柄	把	1
9	ZR1452RB	牙龈剪	双弯	把	1
10	ZM016R	持针钳	140, 直, 细针, 镶片 0.3	把	1
11	ZR2642RB	骨刮匙	180×4×6, 直头, 弯头	把	1
12	ZR2641RB	骨刮匙	180×3×5, 直头, 弯头	把	1
13	ZR022R	牙用镊	160, 单弯, 有定位	把	1
14	ZD668MB	整形镊	125×0.6, 直, 有钩, 精细型	把	1

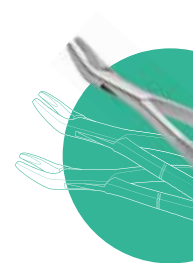



GYS 型骨引导再生套装 (ZR1042)
 GYS Type Bone Guided Regeneration Set

序号	编 码	名 称	规 格	单 位	数 量
1	ZR2511RB	骨膜剥离器	180, 宽 4/6, 圆柄	把	1
2	ZR2509RB	骨膜剥离器	190, 圆头, 铲形, 圆柄	把	1
3	ZC909RB	眼用剪	110, 弯, 镶片	把	1
4	ZM016R	持针钳	140, 直, 细针, 镶片 0.3	把	1
5	ZR1310RB	牙槽咬骨钳	圆口	把	1
6	ZR1874R	剔挖器	4#, 双弯, 双头	支	1
7	ZR2640RB	骨刮匙	180×2×4, 直头, 弯头	把	1
8	ZR2641RB	骨刮匙	180×3×5, 直头, 弯头	把	1
9	ZR2642RB	骨刮匙	180×4×6, 直头, 弯头	把	1
10	ZH110MB	止血钳	125, 直蚊, 全齿	把	1
11	ZD668MB	整形镊	125×0.6, 直, 有钩, 精细型	把	1
12	ZD304MB	整形镊	125×0.4, 直, 有齿, 精细型	把	1
13	ZR1722R	牙刮匙	2#, 双弯铲形, 双头	支	1





GPK 型牙槽嵴骨劈开套装 (ZR1043)
GPK Type Alveolar Ridge Bone Splitting Set

序号	编 码	名 称	规 格	单 位	数 量
1	ZR1525R	口镜	口镜柄	支	1
2	ZR1522R	口镜	5#, 平光, 耐高温	个	1
3	ZR2007RB	牙周袋探针	(1-15)	根	1
4	ZR2190R	吸唾管	Φ3	支	1
5	ZR2140RB	唇颊牵开器	直, 板式	个	1
6	ZR2564RBs	手术刀柄	170, 直型	把	1
7	ZR2508RB	骨膜剥离器	180, 圆头, 平刃, 圆柄	把	1
8	ZR2511RB	骨膜剥离器	180, 宽 4/6, 圆柄	把	1
9	ZR1452RB	牙龈剪	双弯	把	1
10	ZM016R	持针钳	140, 直, 细针, 镶片 0.3	把	1
11	ZR2610RB	牙骨凿	宽 4, 直, 带刻度, 骨劈开	把	1
12	ZR2613RB	牙骨凿	宽 4, 弯, 带刻度, 骨劈开	把	1
13	ZR2611RB	牙骨凿	宽 6, 直, 带刻度, 骨劈开	把	1
14	ZR2612RB	牙骨凿	宽 6, 弯, 带刻度, 骨劈开	把	1
15	ZR2622RB	骨凿	140×6, 直, 双斜刃	把	1
16	ZA117R	不锈钢服药杯	50ml	个	1
17	ZR2641RB	骨刮匙	180×3×5, 直头, 弯头	把	1
18	ZD049RB	医用镊	160, 直	把	1
19	ZD668MB	整形镊	125×0.6, 直, 有钩, 精细型	把	1

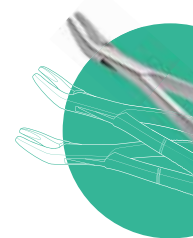

口腔科
Oral Instruments



SWT 型上颌窦底外提升套装 (ZR1044)
SWT Type Maxillary Sinus Floor Lifting Set

序号	编 码	名 称	规 格	单 位	数 量
1	ZR2007RB	牙周袋探针	(1-15)	根	1
2	ZR2564RBs	手术刀柄	170, 直型	把	1
3	ZR2511RB	骨膜剥离器	180, 宽 4/6, 圆柄	把	1
4	ZR2523RB	骨膜剥离器	双头, 200×11, 锐口, 200×12, 钝口, 牙用	把	1
5	ZR1721R	牙刮匙	1#, 直铲形, 双头	支	1
6	ZR2732RB	上颌窦外提升器	180×3×3, 左弯, 右弯	支	1
7	ZR2641RB	骨刮匙	180×3×5, 直头, 弯头	把	1
8	ZR2587RB	牙用输送机	190, 骨粉	把	1
9	ZR2738RB	上颌窦外提升器	骨粉充填, 网纹面, φ6/φ8	支	1
10	ZR2139R	牙骨锤	150	把	1
11	ZM240R	持针钳	140, 直, 细针	把	1
12	ZD559R	组织镊	160, 1×2 钩	把	1
13	ZR2190R	吸唾管	φ3	支	1

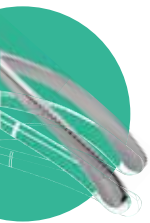



SNT 型上颌窦内提升套装 (ZR1045)
SNT Type Maxillary Sinus Lifting Set

序号	编 码	名 称	规 格	单 位	数 量
1	ZR2701RB	上颌窦提升器	170×φ2.5, 凹头, 直杆, 带定位套	个	1
2	ZR2702RB	上颌窦提升器	170×φ3, 凹头, 直杆, 带定位套	个	1
3	ZR2703RB	上颌窦提升器	170×φ3.5, 凹头, 直杆, 带定位套	个	1
4	ZR2704RB	上颌窦提升器	170×φ4, 凹头, 直杆, 带定位套	个	1
5	ZR2705RB	上颌窦提升器	170×φ4.5, 凹头, 直杆, 带定位套	个	1
6	ZR2706RB	上颌窦提升器	175×φ2.5, 凹头, 弯杆, 带定位套	个	1
7	ZR2707RB	上颌窦提升器	175×φ3, 凹头, 弯杆, 带定位套	个	1
8	ZR2708RB	上颌窦提升器	175×φ3.5, 凹头, 弯杆, 带定位套	个	1
9	ZR2709RB	上颌窦提升器	175×φ4, 凹头, 弯杆, 带定位套	个	1
10	ZR2710RB	上颌窦提升器	175×φ4.5, 凹头, 弯杆, 带定位套	个	1
11	ZR2711RB	上颌窦提升器	170×φ2.5, 圆头, 直杆, 带定位套	个	1
12	ZR2712RB	上颌窦提升器	170×φ3, 圆头, 直杆, 带定位套	个	1
13	ZR2713RB	上颌窦提升器	170×φ3.5, 圆头, 直杆, 带定位套	个	1
14	ZR2714RB	上颌窦提升器	170×φ4, 圆头, 直杆, 带定位套	个	1
15	ZR2715RB	上颌窦提升器	170×φ4.5, 圆头, 直杆, 带定位套	个	1
16	ZR2716RB	上颌窦提升器	175×φ2.5, 圆头, 弯杆, 带定位套	个	1
17	ZR2717RB	上颌窦提升器	175×φ3, 圆头, 弯杆, 带定位套	个	1
18	ZR2718RB	上颌窦提升器	175×φ3.5, 圆头, 弯杆, 带定位套	个	1
19	ZR2719RB	上颌窦提升器	175×φ4, 圆头, 弯杆, 带定位套	个	1
20	ZR2720RB	上颌窦提升器	175×φ4.5, 圆头, 弯杆, 带定位套	个	1

