

Plastic Surgical Instruments
整形外科

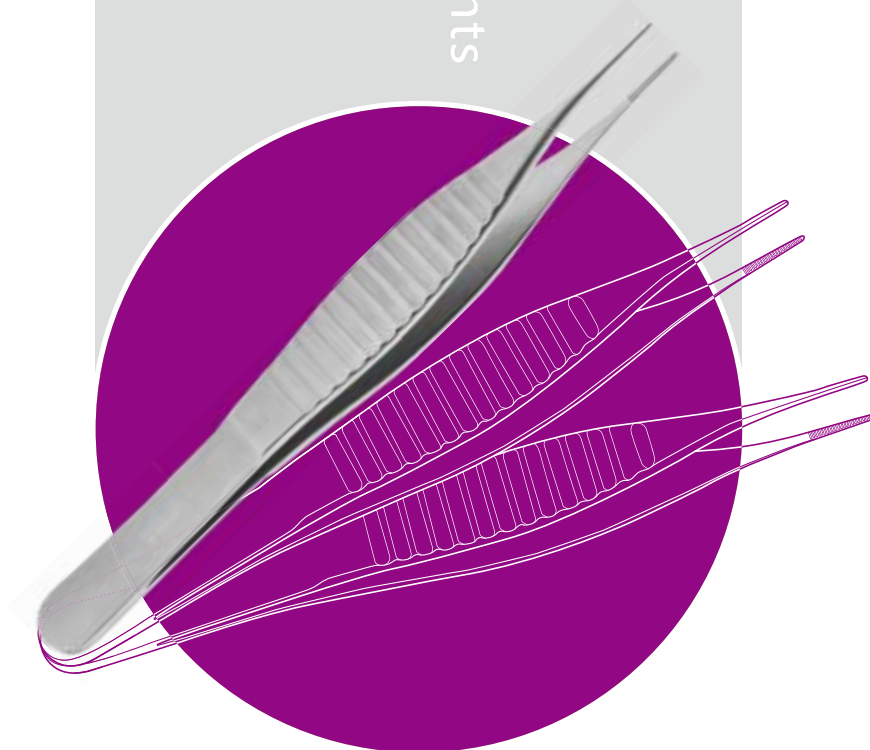

QUALITY
OUR WAY TO SUCCESS

Plastic Surgical Instruments

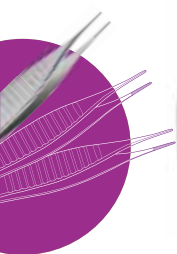

整形外科
 Plastic Surgical Instruments

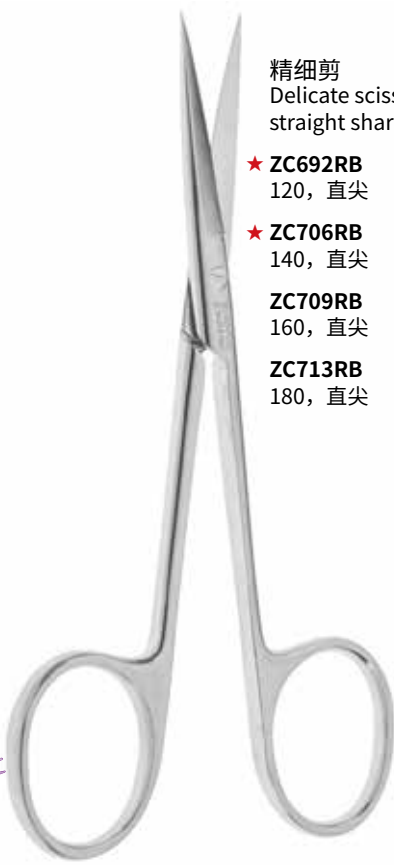

精细剪
 Delicate scissors,
 straight sharp

- ★ ZC692RB
120, 直尖
- ★ ZC706RB
140, 直尖
- ZC709RB
160, 直尖
- ZC713RB
180, 直尖



精细剪
 Delicate scissors,
 curved sharp

- ★ ZC693RB
120, 弯尖
- ★ ZC700RB
140, 弯尖
- ZC710RB
160, 弯尖
- ZC701RB
180, 弯尖

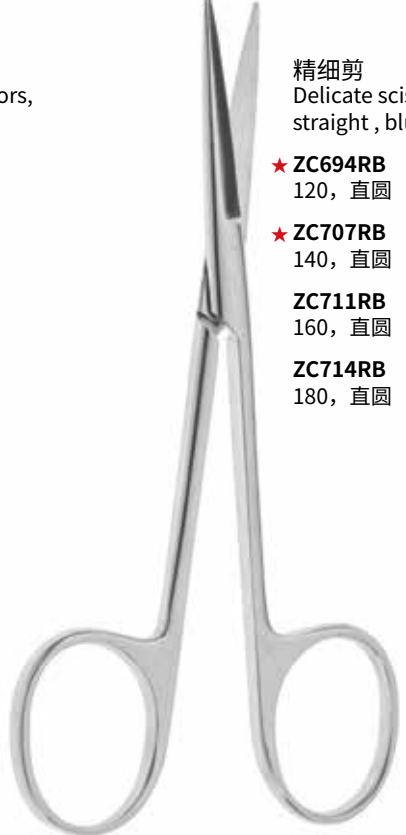

精细剪
 Delicate scissors,
 straight, blunt

- ★ ZC694RB
120, 直圆
- ★ ZC707RB
140, 直圆
- ZC711RB
160, 直圆
- ZC714RB
180, 直圆



精细剪
 Delicate scissors, curved
 blunt

- ★ ZC695RB
120, 弯圆
- ★ ZC708RB
140, 弯圆
- ZC712RB
160, 弯圆
- ZC715RB
180, 弯圆



精细剪
 Delicate scissors, straight

- ★ ZC716RB
140, 直圆窄
- ZC717RB
140, 直圆宽

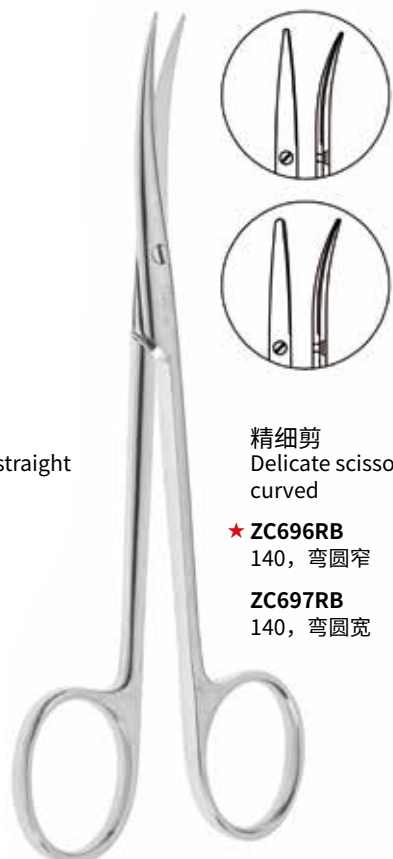

精细剪
 Delicate scissors,
 curved

- ★ ZC696RB
140, 弯圆窄
- ZC697RB
140, 弯圆宽



眼用剪
TC Ophthalmic scissors, straight

- ★ ZC906RB
90, 直, 镶片
- ZC908RB
110, 直, 镶片



眼用剪
TC Ophthalmic scissors, curved

- ★ ZC907RB
90, 弯, 镶片
- ZC909RB
110, 弯, 镶片



精细手术剪
TC Delicate scissors, straight

- ZC910RB
140, 直, 小血管, 镶片



精细手术剪
TC Delicate scissors, curved

- ZC911RB
140, 弯, 小血管, 镶片

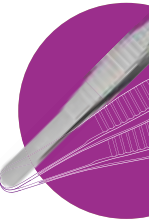



精细剪
TC Delicate scissors,
straight

ZX414RB
100, 直尖



精细剪
TC Delicate scissors,
curved

ZX413RB
100, 弯尖

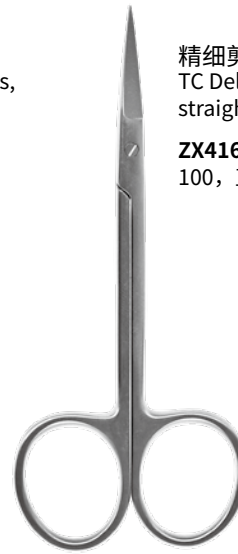

精细剪
TC Delicate scissors,
straight

ZX416RB
100, 直

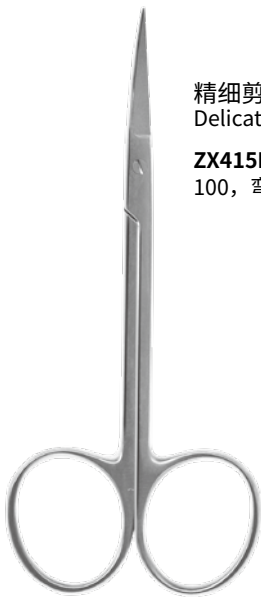

精细剪
Delicate scissors, curved

ZX415RB
100, 弯

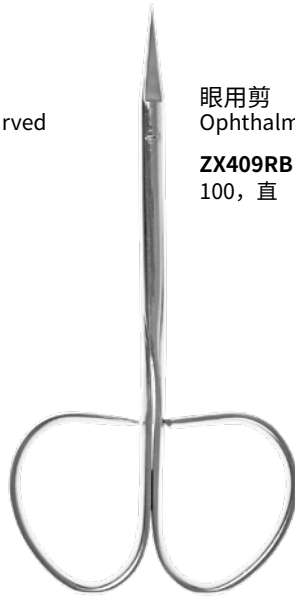

眼用剪
Ophthalmic scissors, straight

ZX409RB
100, 直



眼用剪
Ophthalmic scissors, curved

ZX410RB
100, 弯



眼用剪
Ophthalmic scissors, straight

ZX411RB
100, 直



眼用剪
Ophthalmic scissors, curved

ZX412RB
100, 弯

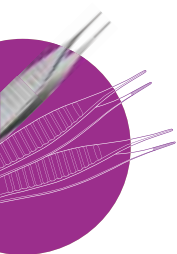

整形外科
Plastic Surgical Instruments

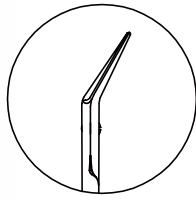

精细剪 (蛙嘴剪)
Delicate scissors, curved/
sharp

- ★ **ZC698RN**
95×145°, 尖头弯
- ★ **ZC699RN**
92×150°, 尖头弯
- ZC871RB**
105×150°, 弯尖头



精细剪 (鸟嘴剪)
Delicate scissors

- ★ **ZC870RB**
115×150°, 弯尖头



显微组织剪
Micro scissors

- ZF100R**
140, 直型, 簧式, 圆柄



显微组织剪
Micro scissors

- ZF101R**
140, 弯型, 簧式, 圆柄

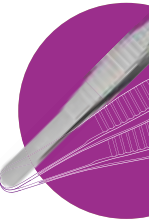



眼科镊 (眼睑镊)
Ophthalmic forceps
★ ZX400RB
100×0.6, 直, 无钩
ZX402RB
100×0.8, 直, 无钩



眼科镊 (眼睑镊)
Ophthalmic forceps, with teeth
★ ZX401RB
100×0.6, 直, 有钩
ZX403RB
100×0.8, 直, 有钩



眼科镊 (超细镊)
Ophthalmic forceps, with teeth
★ ZX404RB
110×0.4, 直, 有钩

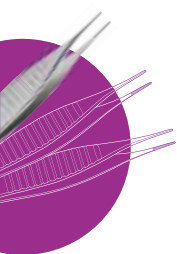

整形外科
Plastic Surgical Instruments



眼科镊 (超细镊)
Ophthalmic forceps
★ ZX405RB
110×0.4, 直, 无钩

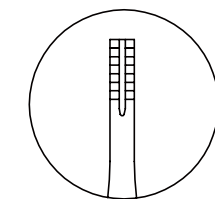

整形镊 (鼻软骨镊)
Adson forceps, straight
ZD236RN
125×2×5, 有齿
★ ZD667RN
125×2×8, 有齿

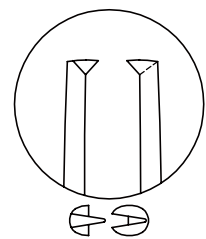

整形镊 (ADSON 镊)
Adson forceps, straight
★ ZD665RN
120×0.6, 直, 有钩
★ ZD678RN
120×0.8, 直, 有钩
ZD675RN
120×1, 直, 有钩
ZD235RN
125×1, 直, 有钩
ZD234RN
125×1.3, 直, 有钩
ZD679RN
150×0.6, 直, 有钩
ZD680RN
150×0.8, 直, 有钩
ZD677RN
150×1.0, 直, 有钩

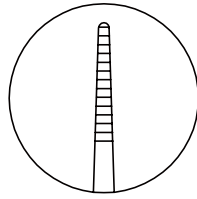

整形镊 (ADSON 镊)
Adson forceps, straight

- ★ **ZD682RN**
120×0.6, 直, 有齿
- ★ **ZD683RN**
120×0.8, 直, 有齿
- ZD684RN**
120×1.0, 直, 有齿
- ZD685RN**
150×0.6, 直, 有齿
- ZD686RN**
150×0.8, 直, 有齿
- ZD687RN**
150×1.0, 直, 有齿

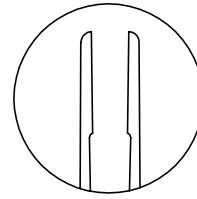

整形镊 (ADSON 镊)
Adson forceps, straight

- ★ **ZD666RN**
120×0.6, 直, 平台
- ZD674RN**
120×1, 直, 平台
- ZD689RN**
150×0.6, 直, 平台
- ZD676RN**
150×1, 直, 平台

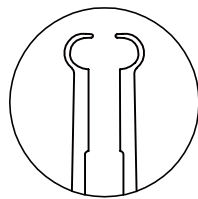

整形镊 (皮肤缝合镊)
Adson forceps

- ★ **ZD669RN**
150, 直, 有钩, straight
- ZD671RN**
150, 弯, 有钩, curved

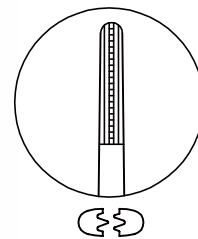

整形镊 (无损伤镊)
Adson forceps

- ZD672RN**
180, 直, 凹凸齿, straight
- ★ **ZD673RN**
180, 弯, 凹凸齿, curved

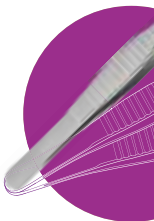



胸腔镊 (无损伤镊)
Atraumatic forceps
ZW389MB
160×1.5, 直



组织镊 (枪型镊)
Dissecting Forceps
Bayonet-Shaped
ZD870MB
160, 枪状, 带齿



显微镊
Micro forceps straight
ZD284R
140×0.3, 直型, 圆柄

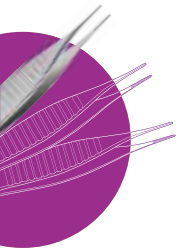

整形外科
Plastic Surgical Instruments



显微镊
Micro forceps curved
ZD282R
140×0.3, 弯型, 圆柄



止血钳
Haemostatic Forceps
Straight, Pean, delicate
ZH108MN
125, 直, 精细



止血钳
Haemostatic Forceps
Straight, Pean, delicate
ZH109MN
125, 弯, 精细

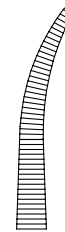



止血钳
Haemostatic Forceps,
Peen, super thin

ZX425RB
125, 直, 超细, straight

ZX426RB
125, 弯, 超细, curved



止血钳
Haemostatic Forceps,
Peen

ZH640RN
200, 弯, 全齿



眼用持针钳
Needle holder, smooth

★ **ZO014RN**
115×2, 无齿

ZO015RN
130×2.5, 无齿

ZO016RN
130×2, 无齿



持针钳
Needle holder, double
curved

★ **ZX242RB**
130, 双弯

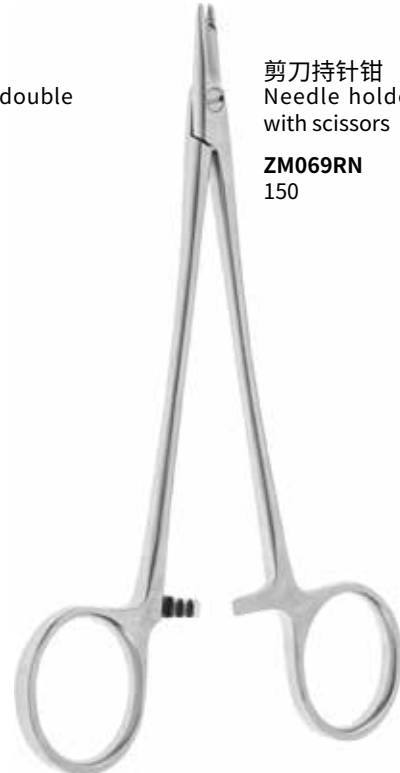

剪刀持针钳
Needle holder
with scissors

ZM069RN
150

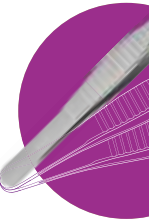



持针钳
Needle Holder
Straight Thin Needle

- ★ **ZM013R**
125, 直, 细针, 镶片 0.3 TC 0.3
- ZM016R**
140, 直, 细针, 镶片 0.3 TC 0.3



持针钳
Needle Holder
Straight Thin Needle

- ZM068R**
125, 直窄, 无损伤针, 镶片 0.2 TC 0.2
- ZM071R**
140, 直窄, 无损伤针, 镶片 0.2 TC 0.2

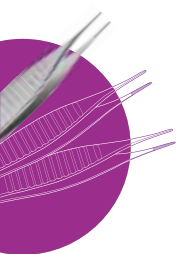

整形外科
Plastic Surgical Instruments



显微持针钳
Micro needle holder
forceps

- ZF236R**
140×0.4, 直型, 叠鳃,
簧式 straight
- ZF237R**
140×0.4 弯型, 叠鳃,
簧式 curved



皮肤拉钩 (微型单爪拉钩)
Skin retractor, sharp

- ★ **ZO341RN**
135×3
- ZO342RN**
135×3.5



皮肤拉钩 (单爪拉钩)
Skin retractor, sharp

- ★ **ZO353RN**
150, 锐, 单齿



皮肤拉钩 (微型双爪拉钩)
Skin retractor, sharp

ZT126RN

120×2×2, 双钩, 锐

★ **ZT127RN**

140×3.2×2.4, 双钩, 锐



皮肤拉钩 (双爪拉钩)
Skin retractor

ZX289RB

125×4, 双钩

ZX290RB

150×8, 双钩

ZX291RB

150×10, 钝, 双钩 blunt

ZX292RB

150×10, 锐, 双钩 sharp



皮肤拉钩 (双爪拉钩)
Skin retractor, sharp

★ **ZO354RN**

150, 双齿, 锐



皮肤拉钩 (双爪拉钩)
Skin retractor, sharp

ZT124RN

160×10×5, 双钩, 锐



鼻腔拉钩 (双球拉钩)
Nasal retractor

ZX295RB

150×7, 双钩, 球头

ZX296RB

150×10, 双钩, 球头

ZX297RB

150×13, 双钩, 球头



鼻腔拉钩 (双球拉钩)
Nasal retractor

ZX121RN

160, 双钩, 球头

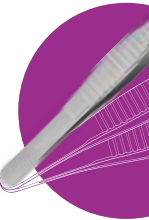



手术刀柄
Scalpel handle
ZB073RN
3# (长度 125mm)



手术刀柄
Scalpel handle
ZB084RN
4# (长度 140mm)



手术刀柄
Scalpel handle
ZX433RN
150



手术刀柄
Scalpel handle
ZX436RN
150, 3#



手术刀柄
Scalpel handle
ZX114RN
200, 3#

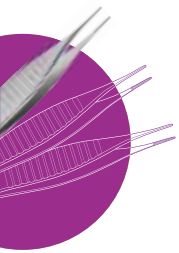

整形外科
Plastic Surgical Instruments



鼻骨凿
Nasal chisel
ZX182RN
180×6, 弯型, V型



鼻骨凿
Nasal chisel
ZX183RN
180, 直型, 斜刃, 单保护



鼻骨凿
Nasal chisel
ZX184RN
180, 左弯, 斜刃, 单保护
left curved



鼻骨凿
Nasal chisel
ZX185RN
180, 右弯, 斜刃, 单保护
right curved



鼻骨凿
Nasal chisel
★ **ZX186RN**
160×10, 直型, 双保护

ZX187RN
160×12, 直型, 双保护

ZX188RN
160×14, 直型, 双保护

ZX189RN
160×16, 直型, 双保护

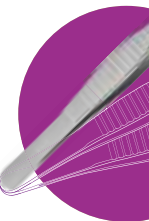



鼻中隔凿
 Nasal septum gouge

ZO407R
 160×3, 枪形



鼻骨凿
 Nasal gouge



ZO359RN
 双保护 6mm×160

ZO360RN
 双保护 8mm×160



ZO361RN
 左保护 6mm×160, left

ZO362RN
 左保护 8mm×160, left



ZO363RN
 右保护 6mm×160, right

ZO364RN
 右保护 8mm×160, right



鼻粘膜刀 (D型刀)
 Nasal knife

★ **ZO477RN**
 170, 直, 单头圆

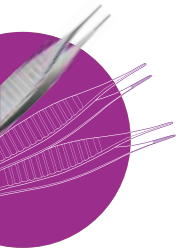

整形外科
 Plastic Surgical Instruments



鼻粘膜刀 (D型刀)
 Nasal knife

ZO482RN
 180×3×5



鼻中隔旋转刀
 Nasal septum knife

ZO444RN
 200, 直型, 刃宽 4



鼻中隔旋转刀
 Nasal septum knife

ZO446RN
 200, 枪型, 刃宽 4



骨刀
 Chisel

ZX248RB
 180, 弯



鼻骨膜剥离器
Nasal periosteum raspatory
ZO414RN
170x4.2, 弯、单头



鼻骨膜剥离器
Nasal periosteum raspatory
ZO545RN
200x4.5x4.5, 双头, 弯



ZX406RB
175x7, 铲式



ZX407RB
175x7, 方头



ZX408RB
175x7, 双刃

鼻骨膜剥离器
Nasal periosteum raspatory



鼻骨膜剥离器
Nasal periosteum raspatory
★ **ZO546RN**
180x5x5, 双头, 弯



鼻骨膜剥离器
Nasal periosteum raspatory

ZO402RN
180x5, 单头带吸引铲形

ZO406RN
180x3, 单头带吸引铲形

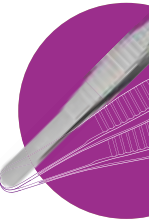

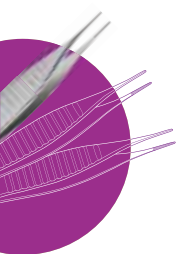

整形外科
Plastic Surgical Instruments



鼻骨膜剥离器
Nasal periosteum
raspator

ZX243RB
190, 弯

ZX244RB
190, 弯



骨膜剥离器
Raspatory

★ **ZX245RN**
200, 左式 left



骨膜剥离器
Raspatory

★ **ZX246RN**
200, 右式 right



骨膜剥离器
Raspatory

ZX247RN
200, 弯



骨膜剥离器
Raspatory

ZX251RN
230, 双头



皮肤拉钩
Skin retractor
★ **ZT125RN**
160, 双头, 16×6,11×4



双头拉钩 (皮肤拉钩)
Retractor
ZX115RN
185×35×20



拉钩 (双头下颌角拉钩)
Retractor
★ **ZX252RN**
145×16×11, 双头
ZX253RN
170×32×22, 双头



拉钩
Retractor
ZX250RN
185×30×19, 双头



拉钩
Retractor
ZX257RN
135, 双头



拉钩 (肋软骨拉钩)
Retractor
★ **ZX288RB**
170×28, 肋软骨
ZX249RB
170×37, 肋软骨

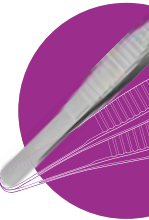

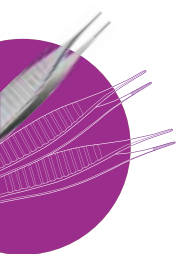

整形外科
Plastic Surgical Instruments



鼻腔拉钩 (自助鼻拉钩)
Nasal retractor
ZX284R
双头, 340



鼻腔拉钩
(鼻深部拉钩)
Nasal retractor
ZX432RB
190



鼻腔拉钩
Nasal retractor
ZT019RN
120, 38×15, 53×6, 双钩



鼻腔填塞钳 (PTFE 置放钳)
Nasal filing forceps
ZX255RN
165

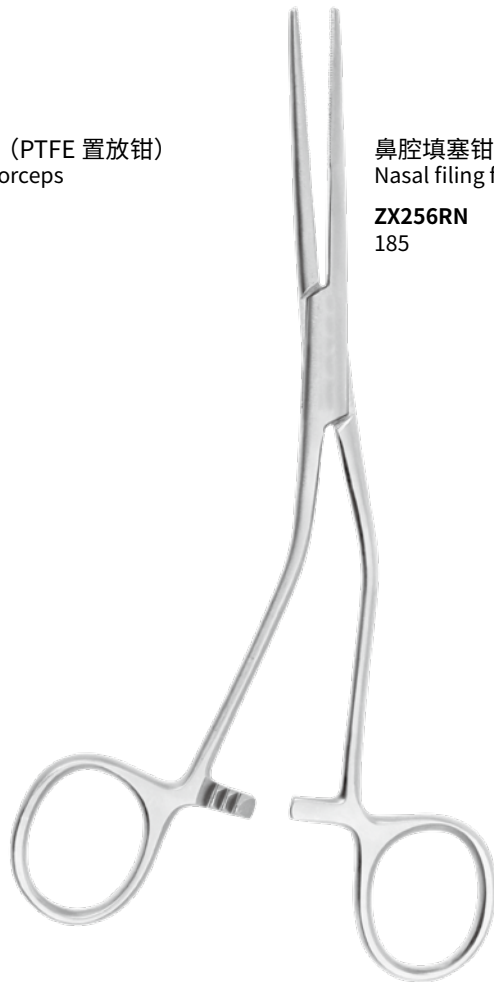

鼻腔填塞钳 (膨体置放钳)
Nasal filing forceps
ZX256RN
185



持骨钳 (软骨钳)
Bone holding forceps

ZX266RB
195, 直



鼻导引器
Nasal guide

ZX254RN
175



雕刻板
Engrave plate aluminum alloy

ZX285R
铝合金, 90×60



雕刻板
Engrave plate silicone

ZX286R
硅胶, 100×80



骨锉
Bone file

ZO461RN
210×7.5, 单头



鼻骨锉
Nasal bone file

ZX427R
190, 横齿



鼻骨锉
Nasal bone file

ZX428R
190, 网纹齿

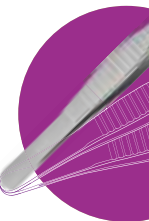

整形外科
Plastic Surgical Instruments

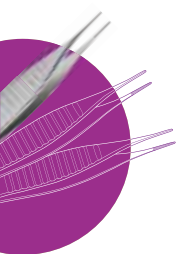

整形外科
Plastic Surgical Instruments



骨锯 (鼻骨锯)
Saw

ZX429R

190×40, 直 straight

ZX430R

190×40, 右 right

ZX431R

190×40, 左 curved



鼻腔吸引管
Nasal suction tube

ZO1081RN

180×Φ3.5×47, 弯



鼻刮匙
Nasal curette

ZO525RN

190×5.5, 单头
直, 匙形

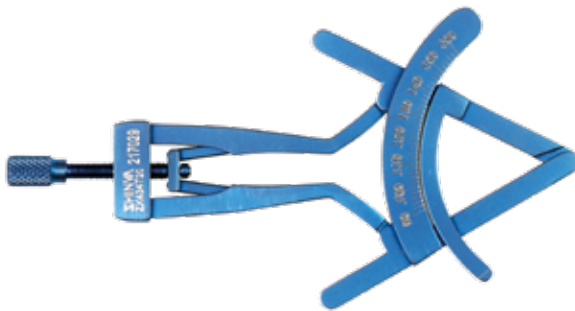

角度尺
Goniometer

ZX434T

90° - 160°



角度尺
Goniometer

ZX435RN

多角度



软骨压碎器 (软骨挤压器)
Cartilage crusher

ZX208RB

65×30×30

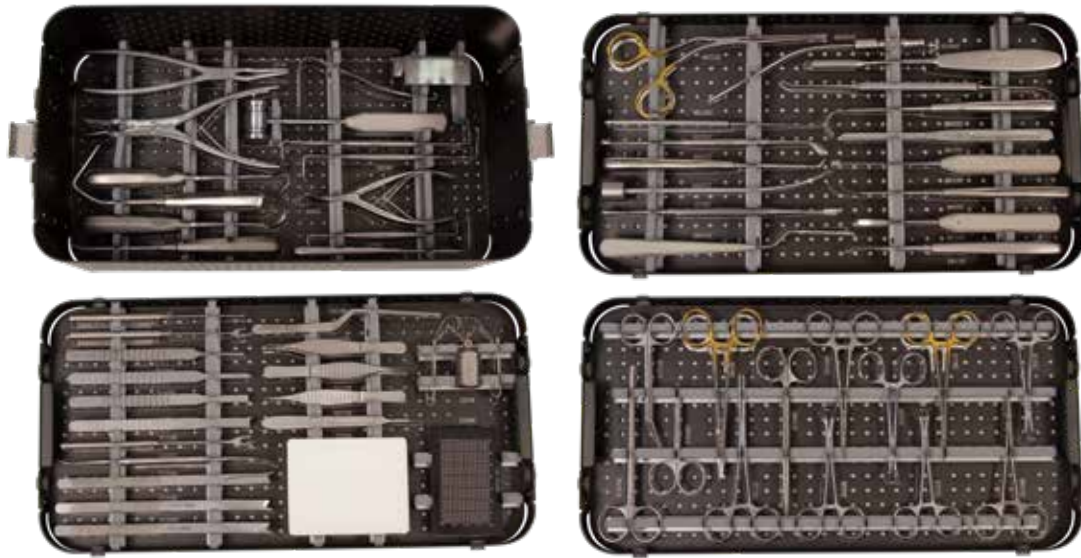

BBZX-I 型鼻部整形手术器械包 (ZX003)
BBZX-I Nasal plastic surgery instruments set

序号	产品编码	产品名称	产品规格	数量	单位
1	ZX254RN	ZX254RN 鼻导引器	175	1	个
2	ZO1032RN	ZO1032RN 鼻骨复位钳	200, 角弯	1	把
3	ZO414RN	ZO414RN 鼻骨膜剥离器	170×4.2, 弯, 单头	1	把
4	ZO546RN	ZO546RN 鼻骨膜剥离器	180×5×5, 双头, 弯	1	把
5	ZX183RN	ZX183RN 鼻骨凿	180, 直型, 斜刃, 单保护	1	把
6	ZX184RN	ZX184RN 鼻骨凿	180, 左弯, 斜刃, 单保护	1	把
7	ZX185RN	ZX185RN 鼻骨凿	180, 右弯, 斜刃, 单保护	1	把
8	ZO081R	ZO081R 鼻窥器	150×28	1	把
9	ZX121RN	ZX121RN 鼻腔拉钩	160, 双钩, 球头	1	把
10	ZX284R	ZX284R 鼻腔拉钩	双头	1	把
11	ZX432RB	ZX432RB 鼻腔拉钩	190	1	把
12	ZX255RN	ZX255RN 鼻腔填塞钳	165	1	把
13	ZO1081RN	ZO1081RN 鼻腔吸引管	180×Φ3.5×47, 弯	1	个
14	ZO477RN	ZO477RN 鼻粘膜刀	170, 直形, 单头, 圆	1	把
15	ZO482RN	ZO482RN 鼻粘膜刀	180, 双头	1	把
16	ZO446RN	ZO446RN 鼻中隔旋转刀	200, 枪形, 刃宽 4	1	把
17	ZX200RN	ZX200RN 鼻中隔凿	185×4	1	把
18	ZX266RB	ZX266RB 持骨钳	195, 直	1	把
19	ZM013R	ZM013R 持针钳	125, 直, 细针, 镶片 0.3	1	把
20	ZM016R	ZM016R 持针钳	140, 直, 细针, 镶片 0.3	1	把
21	ZX285R	ZX285R 雕刻板	90×60	1	个
22	ZX286R	ZX286R 雕刻板	100×80	1	个
23	ZX248RB	ZX248RB 骨刀	180, 弯	1	把
24	ZX170RN	ZX170RN 骨膜剥离器	175×6, 弯, 圆刃	1	把
25	ZX243RB	ZX243RB 骨膜剥离器	190, 弯	1	把



序号	产品编码	产品名称	产品规格	数量	单位
26	ZX244RB	ZX244RB 骨膜剥离器	190, 弯	1	把
27	ZX245RN	ZX245RN 骨膜剥离器	200, 左式	1	把
28	ZX246RN	ZX246RN 骨膜剥离器	200, 右式	1	把
29	ZX247RN	ZX247RN 骨膜剥离器	200, 弯	1	把
30	ZX251RN	ZX251RN 骨膜剥离器	230, 双头	1	把
31	ZC697RB	ZC697RB 精细剪	140, 弯, 圆头, 宽头	1	把
32	ZC700RB	ZC700RB 精细剪	140, 弯, 尖头	1	把
33	ZC698RN	ZC698RN 精细剪	95, 尖头, 弯 145°	1	把
34	ZC870RB	ZC870RB 精细剪	115×150°, 弯尖头	1	把
35	ZX249RB	ZX249RB 拉钩	170×37	1	把
36	ZX250RN	ZX250RN 拉钩	185×30×19, 双头	1	把
37	ZX252RN	ZX252RN 拉钩	145×16×11, 双头	1	把
38	ZX253RN	ZX253RN 拉钩	170×32×22, 双头	1	把
39	ZX257RN	ZX257RN 拉钩	135, 双头	1	把
40	ZO353RN	ZO353RN 皮肤拉钩	150, 锐, 单齿	1	把
41	ZO354RN	ZO354RN 皮肤拉钩	150, 锐, 双齿	1	把
42	ZK103RN	ZK103RN 平骨凿	150×2, 直形, 平刃	1	把
43	ZK104RN	ZK104RN 平骨凿	150×4, 直形, 平刃	1	把
44	ZK105RN	ZK105RN 平骨凿	150×6, 直形, 平刃	1	把
45	ZK106RN	ZK106RN 平骨凿	150×8, 直形, 平刃	1	把
46	ZO461RN	ZO461RN 骨锉	210×7.5, 单头	1	把
47	ZX427R	ZX427R 鼻骨锉	190, 横齿	1	把
48	ZX208RB	ZX208RB 软骨压碎器	65×30×30	1	把
49	ZO525RN	ZO525RN 鼻刮匙	190×5.5, 单头, 直, 匙形	1	把
50	ZB073RN	ZB073RN 手术刀柄	3#	1	把
51	LS059R	LS059R 医用尺	200	1	把
52	ZD667RN	ZD667RN 整形镊	125, 直, 有齿	1	把
53	ZD678RN	ZD678RN 整形镊	120×0.8, 直, 有钩	1	把
54	ZD683RN	ZD683RN 整形镊	120×0.8, 直, 有齿	1	把
55	ZH108MN	ZH108MN 止血钳	125, 直蚊, 全齿, 精细	1	把
56	ZH109MN	ZH109MN 止血钳	125, 弯蚊, 全齿, 精细	1	把
57	ZE432R	ZE432R 帕巾钳	110, 尖头	4	把
58	ZE012R	ZE012R 组织钳	140, 直	1	把
59	ZK044R	ZK044R 骨锤	200/140g	1	把
60	ZD870MB	ZD870MB 组织镊	160, 枪状, 带齿	1	把

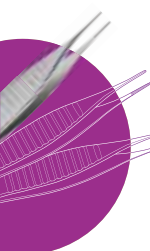



BZX-I 型鼻科整形手术器械包 (ZO1100)
BZX-I nasal plastic surgery instruments set

序号	产品编码	产品名称	产品规格	数量
1	Z0461RN	鼻骨锉	210x7.5mm	1
2	ZT125RN	皮肤拉钩	160, 双头, 16×6, 11×4	1
3	ZO414RN	鼻骨膜剥离器	180×4.2, 锐	1
4	ZD234RN	整形镊	125×1.3×0.7, 1×2 钩	1
5	ZD235RN	整形镊	125×1×0.5, 1×2 钩	1
6	ZD236RN	整形镊	125×2×5	1
7	ZD870RN	组织镊	170, 枪状	1
8	ZC135RN	精细手术剪	115, 弯、圆头	1
9	ZC106RN	精细手术剪	115, 尖头、直	1
10	ZO015RN	眼用持针钳	130x2.4	1
11	ZC698RN	精细剪	95x145°, 弯, 尖尖	1
12	ZT124RN	皮肤拉钩	160×10×5, 双钩, 锐	1
13	ZT126RN	皮肤拉钩	120×2×2, 双钩, 锐	1
14	ZO1083RN	鼻腔吸引管	180×φ3×47	1
15	ZH111MB	止血钳	125, 弯, 蚊式	1
16	ZO545RN	骨膜剥离器	200×4.5×4.5, 双头, 弯	1
17	ZE433MB	帕巾钳	140	1
18	ZB073RN	手术刀柄	3#	1
19	ZO040RN	显微虹膜剪	105, 弯	1
20	ZT019RN	鼻腔拉钩	120, 双钩 38×15, 单钩 53×6	1

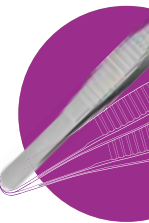

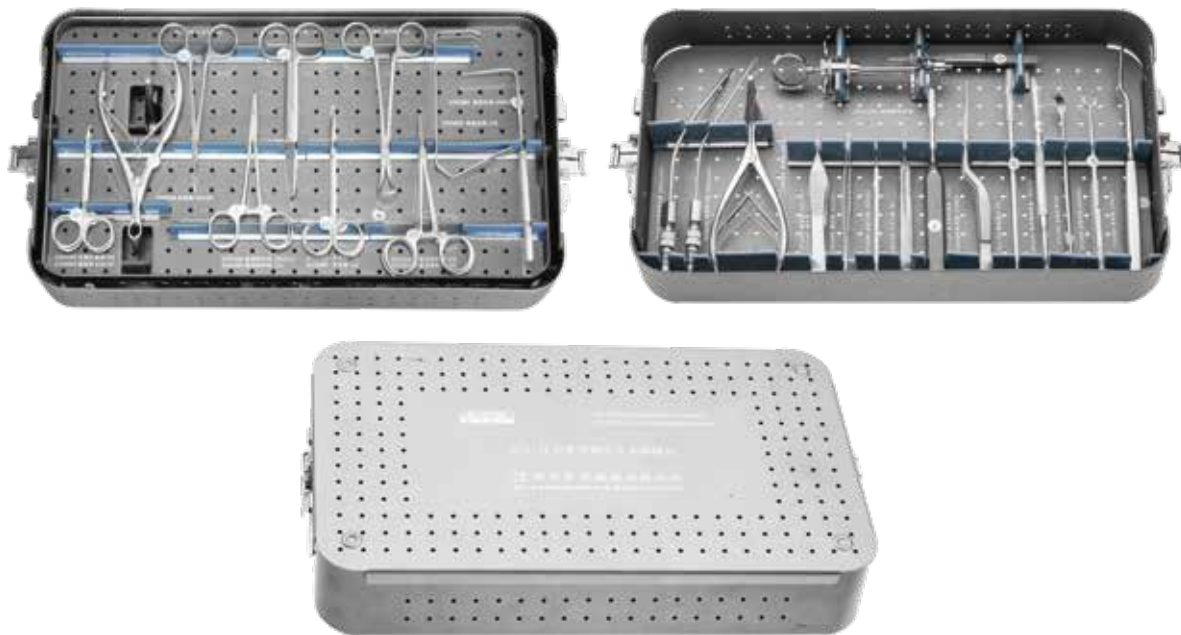

BZX-II 型鼻科整形手术器械包 (ZO1101)
BZX-II nasal plastic surgery instruments set

序号	产品编码	产品名称	产品规格	单位	数量
1	ZB073RN	手术刀柄	3#	把	1
2	ZR2115RB	口腔麻醉注射架		把	1
3	ZC698RN	精细剪	95x145°, 弯, 尖头	把	1
4	ZC135RN	精细手术剪	115, 圆头、弯	把	1
5	ZC106RN	精细手术剪	115, 尖头、直	把	1
6	ZC324RN	精细手术剪	140, 尖头、圆头、直	把	1
7	ZD234RN	整形镊	125×1.3×0.7, 1×2钩	把	1
8	ZD235RN	整形镊	125×1×0.5, 1×2钩	把	1
9	ZD236RN	整形镊	125×2×5	把	1
10	ZD870RN	组织镊	170, 枪状	把	1
11	ZO015RN	眼用持针钳	130x2.5	把	1
12	ZO014RN	眼用持针钳	115	把	1
13	ZH111MB	止血钳	125, 弯、蚊式	把	1
14	ZE433MB	帕巾钳	140	把	1
15	ZT124RN	皮肤拉钩	160×10×5, 双钩, 锐	把	1
16	ZT126RN	皮肤拉钩	120×2×2, 双钩, 锐	把	1
17	ZT125RN	皮肤拉钩	160, 双头, 16×6, 11×4	把	1
18	ZO414RN	鼻骨膜剥离器	180×4.2, 锐	把	1
19	ZO477RN	鼻粘膜刀	170, 直, 单头圆	把	1
20	ZO461RN	鼻骨锉	210x7.5mm	把	1
21	ZT018RN	鼻腔拉钩	160×6	把	1
22	ZO1080RN	鼻腔吸管	180×Φ2.5×47	把	2

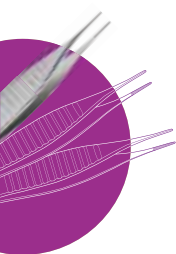

序号	产品编码	产品名称	产品规格	单位	数量
23	ZO1081RN	鼻腔吸引管	180×Φ3.5×47	把	1
24	ZO081R	鼻窥器	150×28	把	1
25	ZO082R	鼻窥器	150×50	把	1
26	ZO040RN	显微虹膜剪	105, 弯	把	1
27	ZD331RN	显微镊	110×0.2	把	1
28	ZO546RN	鼻骨膜剥离器	180×5×5, 双头, 弯	把	1
29	ZT019RN	鼻腔拉钩	120, 双钩38×15, 单钩53×6	把	1
30	ZO12261R	眼用持针钳	112, 直头	把	1

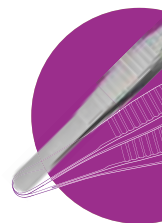

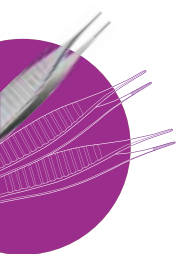

整形外科
 Plastic Surgical Instruments



拉钩
 Retractor
 ★ ZX122RN
 160×15×48, 颈部



拉钩(口角拉钩)
 Retractor
 ZX209RB
 110, 面颊



拉钩(唇颊拉钩)
 Retractor
 ★ ZX210RB
 155, 唇颊

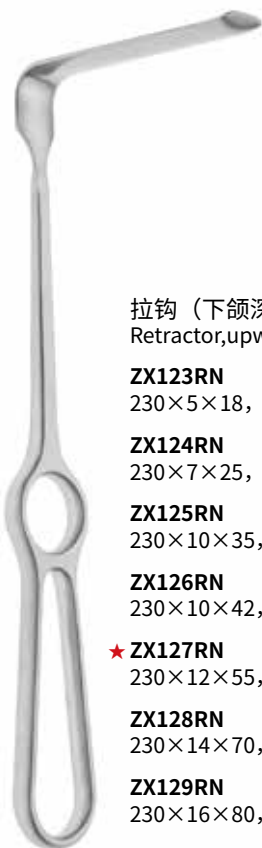

拉钩(下颌深部拉钩)
 Retractor, upwards curved
 ZX123RN
 230×5×18, 上弯, 软组织
 ZX124RN
 230×7×25, 上弯, 软组织
 ZX125RN
 230×10×35, 上弯, 软组织
 ZX126RN
 230×10×42, 上弯, 软组织
 ★ ZX127RN
 230×12×55, 上弯, 软组织
 ZX128RN
 230×14×70, 上弯, 软组织
 ZX129RN
 230×16×80, 上弯, 软组织



拉钩(下颌深部拉钩)
 Retractor, downwards curved
 ZX130RN
 225×5×18, 下弯, 软组织
 ZX131RN
 225×7×25, 下弯, 软组织
 ZX132RN
 225×10×35, 下弯, 软组织
 ★ ZX133RN
 225×10×42, 下弯, 软组织
 ZX134RN
 225×12×55, 下弯, 软组织
 ZX135RN
 225×14×70, 下弯, 软组织
 ★ ZX136RN
 225×16×80, 下弯, 软组织

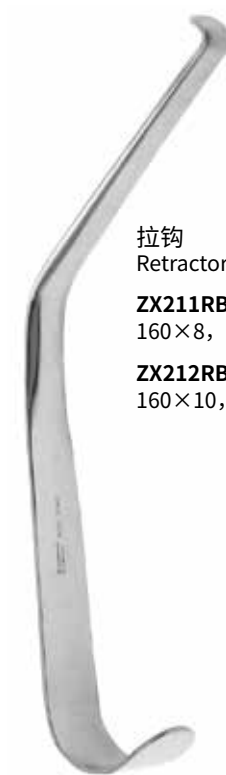

拉钩
 Retractor
 ZX211RB
 160×8, 下颌升支
 ZX212RB
 160×10, 下颌升支



拉钩
Retractor

ZX147RN
170×30, 下颌下缘

★ **ZX148RN**
170×45, 下颌下缘

ZX149RN
170×55, 下颌下缘



拉钩
Retractor

ZX137RN
220×11×70, 下颌内



拉钩
Retractor

★ **ZX138RN**
220×11/15×70, 下颌升支

ZX139RN
220×12/22×70, 下颌升支



拉钩
Retractor

ZX144RN
220×10/23×45,
鼻中隔, 软骨



拉钩
Retractor

ZX145RN
220×13/23×70, 齿槽



拉钩
Retractor

ZX146RN
220×10×42, 鼻中隔

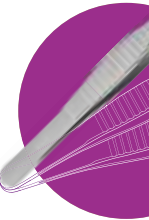

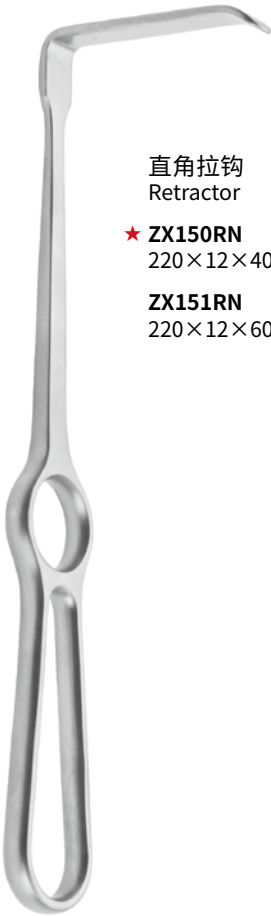

直角拉钩
Retractor

★ **ZX150RN**
220×12×40
ZX151RN
220×12×60



直角拉钩
Retractor

ZX152RN
210×10×30
ZX153RN
210×14×30
ZX154RN
210×16×30



骨拉钩
Retractor

ZX155RN
210×12×40

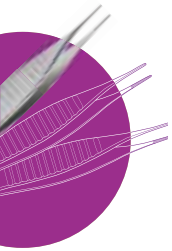

整形外科
Plastic Surgical Instruments



拉钩（口内拉钩）
Retractor

ZX140RN
210×16×26.5, 左弯,
口腔 left



拉钩（口内拉钩）
Retractor

ZX141RN
210×16×26.5, 右弯,
口腔 right



拉钩（口内拉钩、
下颌角分离器）
Retractor

ZX142RN
250×12.5×27,
前上弯, 口腔



拉钩(口内拉钩)
Retractor

ZX143RN
220×9.5×16,
上弯, 口腔



拉钩
Retractor

ZX221RB
220×16×9.5, 上弯,
口腔, 导光



拉钩
Retractor

ZX222RB
230×25.5, 弯,
口腔下颌骨, 导光



拉钩
Retractor

ZX223RB
210×16×26.5, 左弯,
口腔, 导光 left



拉钩
Retractor

ZX224RB
210×16×26.5, 右弯
口腔, 导光 right



拉钩
Retractor

ZX225RB
250×27×12.5, 前上弯
口腔, 导光

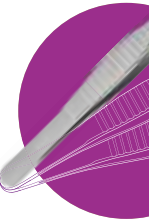

整形外科
Plastic Surgical Instruments



拉钩
Retractor
ZX226RB
250×14.5, 下弯,
口腔, 导光



骨膜剥离器
(下颌前缘剥离子)
Raspatory
ZX162RN
175



剥离器
Raspatory
ZX163RN
180×6, 方刃, 扁柄
ZX164RN
180×9, 方刃, 扁柄



骨膜剥离器
Raspatory
★ **ZX170RN**
175×6, 单头, 弯圆刃
★ **ZX171RN**
175×7, 单头, 弯圆刃
ZX172RN
175×9, 单头, 弯圆刃
ZX173RN
175×11, 单头, 弯圆刃

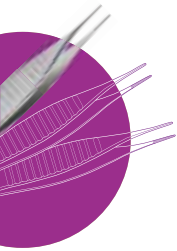

整形外科
Plastic Surgical Instruments



剥离器 (德式下颌角外板剥离子 (左))
Raspatory
ZX174RN
180, 左式, 下颌内缘
Left



剥离器 (德式下颌角外板剥离子 (右))
Raspatory
ZX175RN
180, 右式, 下颌内缘
Right



剥离器 (德式下颌角后缘剥离子 (直角))
Raspatory
ZX176RN
200×5×7, 弯, 圆刃, 扁柄
ZX177RN
200×7×10, 弯, 圆刃, 扁柄
ZX178RN
200×9×11, 弯, 圆刃, 扁柄



骨刀
Osteotome

- ZX197RN**
150×2.5, 超薄圆刃
- ZX198RN**
150×4, 超薄圆刃
- ZX199RN**
150×6.5, 超薄圆刃



骨凿
Gouge

- ★ **ZX191RN**
230×8, 弯, 扁柄
- ZX192RN**
230×10, 弯, 扁柄
- ZX193RN**
230×11, 弯, 扁柄



骨凿
Gouge

- ★ **ZX190RN**
230×12, 深弯, 扁柄



骨刀
Chisel

- ZX203RN**
215×7, 直, 双斜刃,
胶木柄
- ZX204RN**
215×10, 直, 双斜刃,
胶木柄



骨刀 (胶木柄)
Gouge

- ★ **ZX194RN**
220×8, 超薄圆刃
- ZX195RN**
220×12, 超薄圆刃
- ZX196RN**
220×16, 超薄圆刃

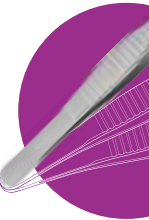



鼻骨凿 (鼻中隔凿)
Septum chisel

ZX200RN
185×4

ZX201RN
185×6



鼻骨凿 (鼻中隔凿)
Septum chisel

ZX202RN
185×6, V型



咬骨钳
Rongeur forceps

ZX217RB
170×2, 单关节, 微弯



咬骨钳
Rongeur forceps

ZX218RB
165×2, 单关节, 深弯



正颌专用钳
Orthognathic plier

ZX233RN
180×12, 凸齿, 骨片成形钳



正颌专用钳
Orthognathic plier

ZX234RN
180×12, 凹齿, 骨片成形钳

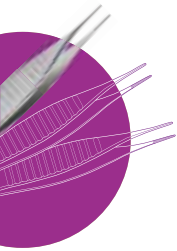

整形外科
Plastic Surgical Instruments



正颌专用钳
Orthognathic plier

ZX235RN
220×17, 4×5 齿, 窄头,
骨劈开钳

ZX236RN
220×20, 5×6 齿, 宽头,
骨劈开钳

正颌专用钳
Orthognathic plier

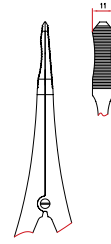

ZX237RN
225×10, 直, 关节撑开钳 Straight

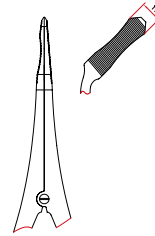

ZX238RN
215×10, 左弯, 关节撑开钳 Left curved

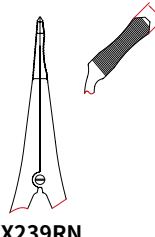

ZX239RN
215×10, 右弯, 关节撑开钳 Right curved



正颌专用钳
Orthognathic plier

ZX240RB
200×13, 左弯, 髁突把持钳 Left curved

ZX241RB
200×13, 右弯, 髁突把持钳 Right curved

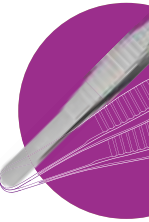
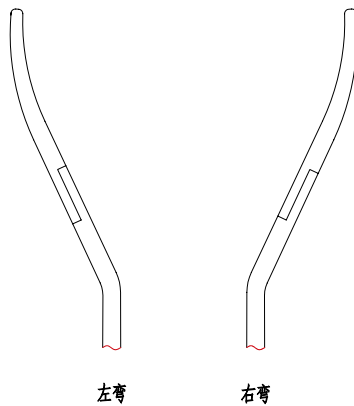



骨科复位钳
Orthopaedic reduction
forceps

ZX215RB
235, 左式, 上颌骨 Left



骨科复位钳
Orthopaedic reduction
forceps

ZX216RB
235, 右式, 上颌骨 Right



正颌专用钳 (钢丝圈钳)
Orthognathic plier

ZX161RN
160

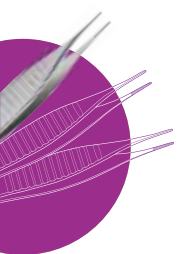

整形外科
Plastic Surgical Instruments



钢丝剪
Wire cutting scissors

ZX159RN
160



持骨钳
Bone holding forceps

ZK189RB
190, I 型



持骨钳
Bone holding forceps

ZK193RB
190, II 型



牙正畸结扎器
Orthodontics
ligator
ZX160RN
180



结扎缝合引线器
Ligature guide
★ **ZX213RB**
130, 下颌骨



结扎缝合引线器
Ligature guide
★ **ZX214RB**
230, 颧骨



结扎缝合引线器
Ligature guide
ZX219RB
180, 鼻或牙槽



压舌板
Tongue depressor
ZX165RN
140×28×80, 角型
★ **ZX166RN**
150×38×80, 角型



骨撬
Lever
ZX169RN
210, 弯型, 颧骨

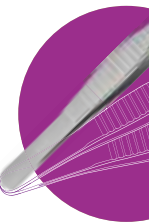

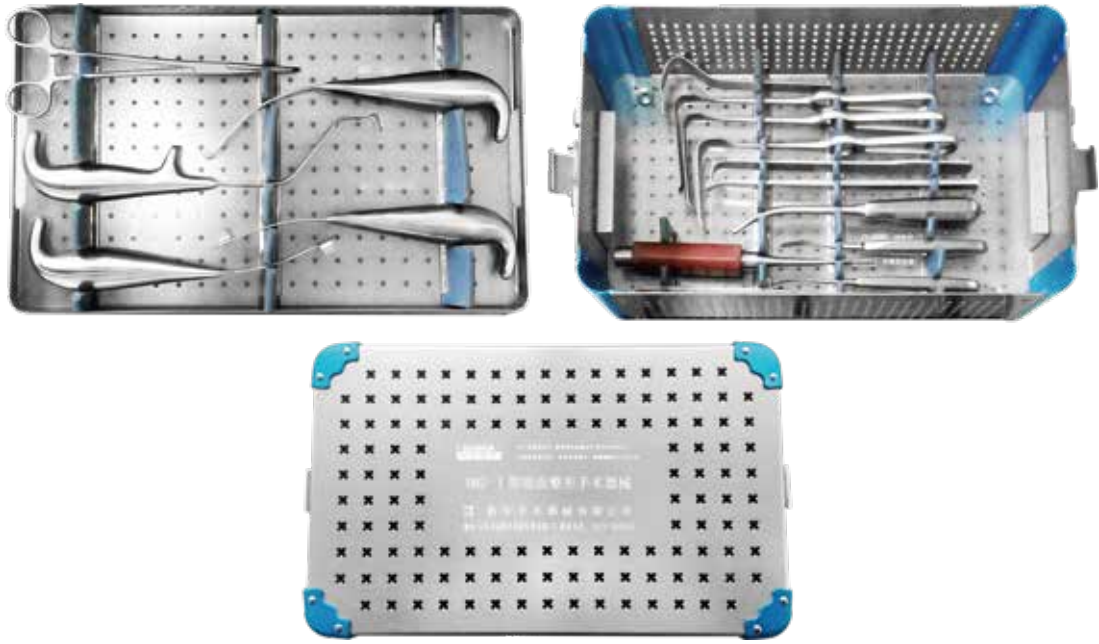

HMZ-I 型颌面整形手术器械包 (ZX002)
HMZ-I maxillofacial surgery instruments set

序号	产品编码	产品名称	产品规格	单位	数量
1	ZE083RN	止血钳	200x15x90°x3, 直角	把	1
2	ZX122RN	拉钩	160x15x48, 颈部, 拉钩	把	1
3	ZX129RN	拉钩	230x16x80, 上弯, 软组织	把	1
4	ZX136RN	拉钩	225x16x80, 下弯, 软组织	把	1
5	ZX139RN	拉钩	220x12/22x70, 下颌升支	把	1
6	ZX140RN	拉钩	210x16x26.5, 左弯, 口腔	把	1
7	ZX141RN	拉钩	210x16x26.5, 右弯, 口腔	把	1
8	ZX142RN	拉钩	250x12.5x27, 前上弯, 口腔	把	1
9	ZX143RN	拉钩	220x9.5x16, 上弯, 口腔	把	1
10	ZX169RN	骨撬	210, 颧骨	把	1
11	ZX172RN	骨膜剥离器	175x9	把	1
12	ZX173RN	骨膜剥离器	175x11	把	1
13	ZX190RN	骨凿	230x12, 深弯, 扁柄	把	1
14	ZX191RN	骨凿	230x8, 弯, 扁柄	把	1
15	ZX194RN	骨刀(胶木柄)	220x8, 超薄圆刃	把	1
16	ZX198RN	骨凿	150x4, 超薄圆刃	把	1

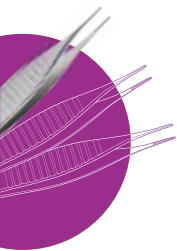



HMZX-I 型颌面整形器械包 (ZX005)
HMZX-I maxillofacial surgery instruments set

序号	产品编码	产品名称	产品规格	数量	单位
1	ZX201RN	ZX201RN 鼻中隔凿	185×6	1	把
2	ZM022R	ZM022R 持针钳	200, 直, 细针, 镶片 0.3	1	把
3	ZM237RN	ZM237RN 持针钳	200, 直, 粗针	1	把
4	ZX159RN	ZX159RN 钢丝剪	160	1	把
5	ZX194RN	ZX194RN 骨刀	220×8, 直, 超薄刃, 圆刃, 胶木柄	1	把
6	ZX195RN	ZX195RN 骨刀	220×12, 直, 超薄刃, 圆刃, 胶木柄	1	把
7	ZX196RN	ZX196RN 骨刀	220×16, 直, 超薄刃, 圆刃, 胶木柄	1	把
8	ZX215RB	ZX215RB 骨科复位钳	235, 左式, 上颌骨	1	把
9	ZX216RB	ZX216RB 骨科复位钳	235, 右式, 上颌骨	1	把
10	ZX171RN	ZX171RN 骨膜剥离器	175×7, 弯, 圆刃	1	把
11	ZX173RN	ZX173RN 骨膜剥离器	175×11, 弯, 圆刃	1	把
12	ZX162RN	ZX162RN 骨膜剥离器	175	1	把
13	ZX190RN	ZX190RN 骨凿	230×12, 深弯, 扁柄	1	把
14	ZX191RN	ZX191RN 骨凿	230×8, 弯, 扁柄	1	把
15	ZX192RN	ZX192RN 骨凿	230×10, 弯, 扁柄	1	把
16	ZX193RN	ZX193RN 骨凿	230×11, 弯, 扁柄	1	把
17	ZX219RB	ZX219RB 结扎缝合引线器	180	1	把
18	ZX138RN	ZX138RN 拉钩	220×11/15×70, 下颌升支	1	把
19	ZX139RN	ZX139RN 拉钩	220×12/22×70, 下颌升支	1	把
20	ZX142RN	ZX142RN 拉钩	250×12.5×27, 前上弯, 口腔	1	把
21	ZX122RN	ZX122RN 拉钩	160×15×48, 颞部	1	把
22	ZX140RN	ZX140RN 拉钩	210×16×26.5, 左弯, 口腔	1	把

序号	产品编码	产品名称	产品规格	数量	单位
23	ZX141RN	ZX141RN 拉钩	210×16×26.5, 右弯, 口腔	1	把
24	ZX128RN	ZX128RN 拉钩	230×14×70, 上弯, 软组织	1	把
25	ZX131RN	ZX131RN 拉钩	225×7×25, 下弯, 软组织	1	把
26	ZX132RN	ZX132RN 拉钩	225×10×35, 下弯, 软组织	1	把
27	ZX135RN	ZX135RN 拉钩	225×14×70, 下弯, 软组织	1	把
28	ZX211RB	ZX211RB 拉钩	160×8, 下颌升支	1	把
29	ZK104RN	ZK104RN 平骨凿	150×4, 直形, 平刃	1	把
30	ZK105RN	ZK105RN 平骨凿	150×6, 直形, 平刃	1	把
31	ZK106RN	ZK106RN 平骨凿	150×8, 直形, 平刃	1	把
32	ZT098R	ZT098R 显微钩	130×Φ0.7×4, 角弯 90°, 钝头	1	把
33	ZX160RN	ZX160RN 牙正畸结扎器	180	1	把
34	ZO20005R	ZO20005R 眼用测量规	0-20, 直	1	个
35	ZK652RNh	ZK652RNh 咬骨钳	180×3×20°, 弯头, 双关节	1	把
36	ZK649RNh	ZK649RNh 咬骨钳	180×3, 直头, 双关节	1	把
37	ZX106RN	ZX106RN 整形分离器	155, 直圆	1	把
38	ZX103RN	ZX103RN 整形分离器	180, 右弯	1	把
39	ZX102RN	ZX102RN 整形分离器	180, 左弯	1	把
40	ZX161RN	ZX161RN 正颌专用钳	160	1	把
41	ZX235RN	ZX235RN 正颌专用钳	220×17, 4×5 齿, 窄头, 骨劈开钳	1	把
42	ZX238RN	ZX238RN 正颌专用钳	215×10, 左弯, 关节撑开钳	1	把

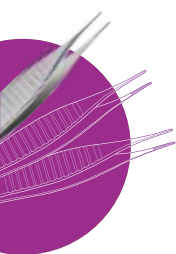



分离器
Raspatory



ZX102RN
180 左弯 left



ZX104RN
180 左上侧 left



ZX106RN
155 直圆 straight



ZX103RN
180 右弯 right



ZX105RN
180 右上侧 right



ZX118RN
180, 直角弯



唇夹
Lip clip

★ **ZX112RN**
80×50, 左角弯 left angled



唇夹
Lip clip

ZX113RN
80×50, 右角弯 right angled



口腔开口器 (框式)
Mouth gag

ZR812RN
(共三把拉钩)

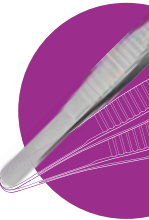

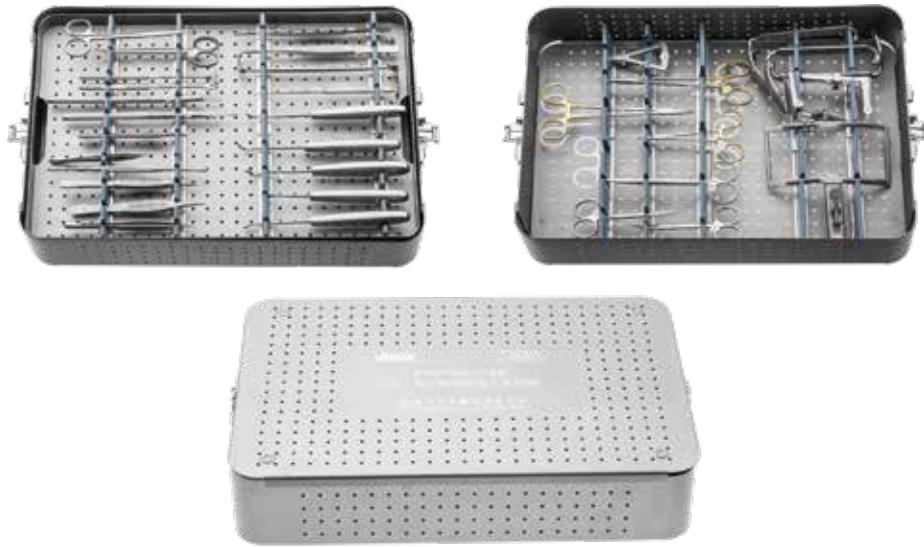

CEL-I 唇腭裂修复手术器械包 (ZX100)

CEL-I nonsyndromic cleft lip and palate instruments set

序号	产品编码	产品名称	产品规格	数量	单位
1	ZR812RN	口腔开口器	框式	1	套
2	ZX102RN	整形分离器	180, 左弯	1	把
3	ZX103RN	整形分离器	180, 右弯	1	把
4	ZX104RN	整形分离器	180, 左上侧	1	把
5	ZX105RN	整形分离器	180, 右上侧	1	把
6	ZX106RN	整形分离器	155, 直圆	1	把
7	ZX112RN	唇夹	80x50, 左角弯	1	把
8	ZX113RN	唇夹	80x50, 右角弯	1	把
9	ZX115RN	双头拉钩	180x35x20, 直角	1	把
10	ZT110RN	皮肤拉钩	160x5, 单钩	1	把
11	ZX121RN	鼻腔拉勾	160, 球头	2	把
12	ZO546RN	鼻骨膜剥离器	180x5x5, 双头, 弯	1	把
13	ZC693RB	精细剪	120, 弯尖	2	把
14	ZC700RB	精细剪	140, 弯尖	2	把
15	ZC710RB	精细剪	160, 弯尖	1	把
16	ZD672RN	整形镊	180, 直, 无损伤	1	把
17	ZD673RN	整形镊	180, 角弯, 无损伤	1	把
18	ZM013R	持针钳	125, 直, 细针, 镶片	2	把
19	ZM017R	持针钳	180, 直, 细针, 镶片	2	把
20	ZD674RN	整形镊	120x1, 直, 平台,	1	把
21	ZD675RN	整形镊	120x1, 直, 1x2钩	1	把
22	ZD676RN	整形镊	150x1, 直, 平台	1	把
23	ZD677RN	整形镊	150x1, 直, 1x2钩	1	把
24	ZD671RN	整形镊	150, 弯, 圆钩	1	把
25	ZO20005R	眼用测量规	0-20, 直	1	个
26	ZX114RN	手术刀柄	3#, 圆柄	2	把

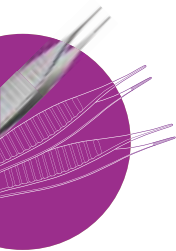



眼用测量规 (睑缘测量器)
Castroviejo Caliper

ZX287R
30mm



眼用测量规 (睑缘测量器)
Castroviejo Caliper

ZX298R
30mm, 枪型



眼用测量规 (眼眶测量器)
Castroviejo Caliper

ZO20025R
0-20, 弯 Curved



眼用测量规 (眼眶测量器)
Castroviejo Caliper

ZO20025T
0-20, 弯 Curved

ZO20005T
0-20, 直 Straight



眼睑拉钩 (耙式拉钩)
Eyelid retractor

ZO14602R
140, 头宽 3.5 tip w. 3.5



眼睑拉钩 (耙式拉钩)
Eyelid retractor

ZO14602RA
140, 头宽 7 tip w. 7

★ **ZO14602RB**
140, 头宽 9 tip w. 9

ZO14602RC
140, 头宽 11 tip w. 11



眼睑拉钩 (耙式拉钩)
Eyelid retractor

ZO14602T
140, 头宽 3.5 tip w. 3.5

ZO14602TA
140, 头宽 7 tip w. 7

ZO14602TB
140, 头宽 9 tip w. 9

ZO14602TC
140, 头宽 11 tip w. 11

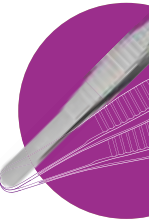

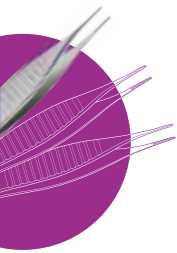

整形外科
Plastic Surgical Instruments



眼袋拉钩
Eyelid retractor

ZX283R
双头, 260



眼袋拉钩
Eyelid retractor

ZX293RB
150×5
★ **ZX294RB**
150×7.5



开睑器 (眼睑板)
speculum

ZO20006R
100, 片状



开睑器 (眼睑板)
speculum

ZO20006T
100, 片状



重睑设计器
Eyelid designer
ZX220R
170×Φ0.8, 弧型



重睑设计器
Eyelid designer
★ **ZX227T**
130×20, Z型



重睑设计器
Eyelid designer
★ **ZX229R**
130×8, 三角型



重睑设计器
Eyelid designer
ZX231R
130×11, U型



重睑设计器
Eyelid designer
ZX232R
130×10.5, T型

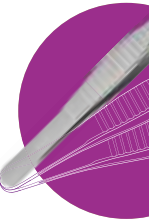

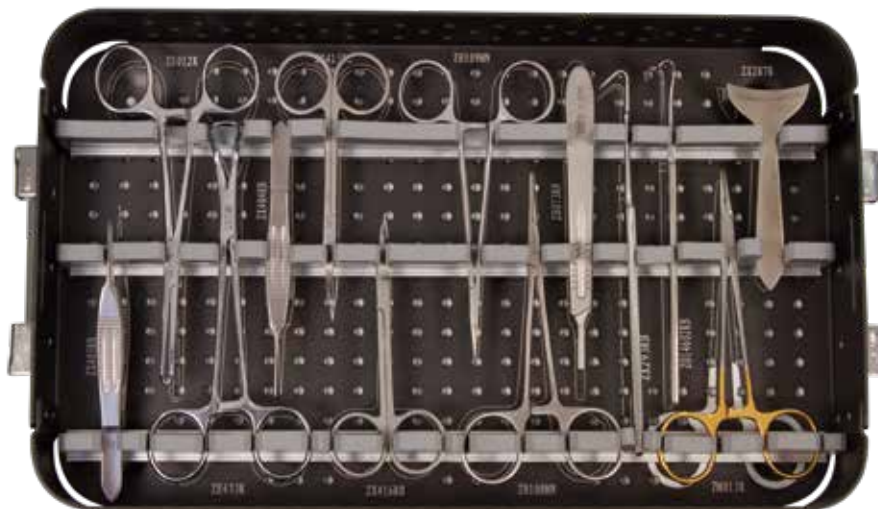

YDQC-I 型眼袋切除整形手术器械包 (ZX006)
YDQC-I eyelid plastic surgery instruments set

序号	产品编码	产品名称	产品规格	数量	
1	ZX404RB	ZX404RB 眼科镊	110×0.4, 直, 有钩	1	把
2	ZX405RB	ZX405RB 眼科镊	110×0.4, 直, 无钩	1	把
3	ZX416RB	ZX416RB 精细剪	100, 直	1	把
4	ZX415RB	ZX415RB 精细剪	100, 弯	1	把
5	ZH108MN	ZH108MN 止血钳	125, 直蚊, 全齿, 精细	1	把
6	ZH109MN	ZH109MN 止血钳	125, 弯蚊, 全齿, 精细	1	把
7	ZM013R	ZM013R 持针钳	125, 直, 细针, 镶片 0.3	1	把
8	ZO14602RB	ZO14602RB 眼睑拉钩	140, 头宽 9	1	把
9	ZX293RB	ZX293RB 眼袋拉钩	150×5	1	把
10	ZE012R	ZE012R 组织钳	140, 直	1	把
11	ZB073RN	ZB073RN 手术刀柄	3#	1	把
12	ZE433R	ZE433R 帕巾钳	140, 尖头	1	把
13	ZX287R	ZX287R 睑缘测量器	30, 直型	1	个

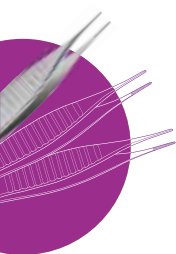



CJZX-I 型重睑整形手术器械包 (ZX007)
CJZX-I eyelid reconstruction instruments set

序号	产品编码	产品名称	产品规格	数量	单位
1	ZX414RB	ZX414RB 精细剪	100, 直	1	把
2	ZX413RB	ZX413RB 精细剪	100, 弯	1	把
3	ZX411RB	ZX411RB 眼用剪	100, 直	1	把
4	ZM013R	ZM013R 持针钳	125, 直, 细针, 镶片 0.3	1	把
5	ZH108MN	ZH108MN 止血钳	125, 直蚊, 全齿, 精细	1	把
6	ZH109MN	ZH109MN 止血钳	125, 弯蚊, 全齿, 精细	1	把
7	ZE432R	ZE432R 帕巾钳	110, 尖头	4	把
8	ZE012R	ZE012R 组织钳	140, 直	1	把
9	ZX401RB	ZX401RB 眼科镊	100×0.6, 直, 有钩	1	把
10	ZX400RB	ZX400RB 眼科镊	100×0.6, 直, 无钩	1	把
11	ZX404RB	ZX404RB 眼科镊	110×0.4, 直, 有钩	1	把
12	ZX405RB	ZX405RB 眼科镊	110×0.4, 直, 无钩	1	把
13	ZO14602RB	ZO14602RB 眼睑拉钩	140, 头宽 9	1	把
14	ZX293RB	ZX293RB 眼袋拉钩	150×5	1	把
15	ZX294RB	ZX294RB 眼袋拉钩	150×7.5	1	把
16	ZO341RN	ZO341RN 皮肤拉钩	135×3, 锐, 单钩	1	把
17	ZO353RN	ZO353RN 皮肤拉钩	150, 锐, 单齿	1	把
18	ZX289RB	ZX289RB 皮肤拉钩	125×4, 双钩	1	把
19	ZO354RN	ZO354RN 皮肤拉钩	150, 锐, 双齿	1	把
20	ZB073RN	ZB073RN 手术刀柄	3#	1	把
21	ZX287R	ZX287R 睑缘测量器	30, 直型	1	个
22	ZO20006R	ZO20006R 开睑器	100, 片状	1	个
23	ZO20005T	ZO20005T 眼用测量规	0-20, 直	1	个
24	ZX220R	ZX220R 重睑设计器	弧形, 170×φ0.8	1	把
25	ZX227T	ZX227T 重睑设计器	Z 形, 130×20	1	把
26	ZX229R	ZX229R 重睑设计器	三角形, 130×8	1	把

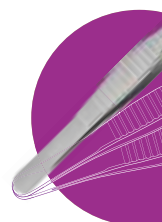



YZX-I 型眼科手术器械包 (ZO20200R)
YZX-I eye surgery instruments set

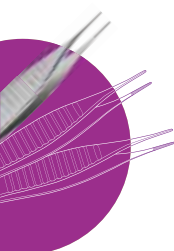

整形外科
Plastic Surgical Instruments

序号	产品编码	产品名称	产品规格	数量	单位
1	ZO040RN	显微虹膜剪	105, 弯	1	把
2	ZO014RN	眼用持针钳	115	1	把
3	ZO015RN	眼用持针钳	130×2.5	1	把
4	ZO016RN	眼用持针钳	130×2	1	把
5	ZO341RN	皮肤拉钩	135×3	1	把
6	ZO342RN	皮肤拉钩	135×3.5	1	把
7	ZB073RN	手术刀柄	3#	1	把
8	ZH640RN	止血钳	200, 弯	1	把
9	ZH111MB	止血钳	125, 弯 蚊式	1	把
10	ZD234RN	整形镊	125×1.3×0.7 1×2钩	1	把
11	ZD236RN	整形镊	125×2×5	1	把
12	ZO078RN	开睑器	125 板式	1	把
13	ZO20005R	眼用测量规	0-20, 直	1	把
14	ZC106RN	手术剪	115, 直尖	1	把
15	ZC135RN	手术剪	115, 弯圆	1	把
16	ZO14602RC	眼睑拉钩	140×11	1	把
17	ZE431MB	帕巾钳	90	1	把
18	ZD331RN	显微镊	110×0.2 无牙	1	把
19	ZO11132R	缝线结扎镊	105×0.5, 直, 1×2齿, 带台	2	把



乳房剥离器
Breast raspatory
ZX275RN
220×30, 框型



乳房剥离器
Breast raspatory
ZX276RB
415, 正弯, 铲形

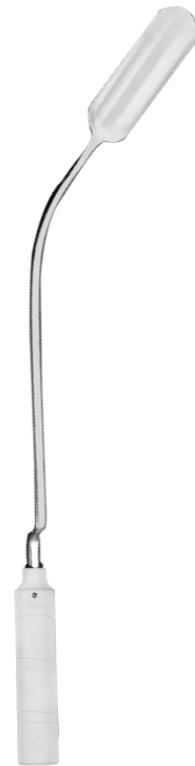

乳房剥离器
Breast raspatory
ZX277RB
400, 左弯, 铲形 Left



乳房剥离器
Breast raspatory
ZX278RB
400, 右弯, 铲形 Right



乳房剥离器
Breast raspatory
ZX279RB
260, U型, 铲形



乳房剥离器
Breast raspatory
ZX282RB
350, 镰刀式

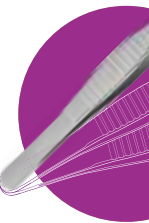



甲状腺拉钩
Retractor

ZT025R
117, 10×23/10×35

ZT026R
120, 10×25/10×37

ZT028R
(117, 120) 一副 One set



甲状腺拉钩
Retractor

ZT029R
155, 15×33/15×42

ZT030R
160, 15×38/15×47



甲状腺拉钩
Retractor

ZT031R
200, 一副, 带槽 One set



乳房拉钩
Breast retractor

ZX280RB
195×120×25

ZX281RB
195×100×25

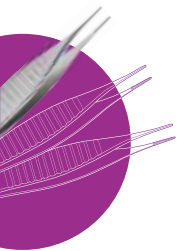



RFZX-I 型乳房整形手术器械包 (ZX004)
RFZX-I breast plastic surgery instruments set

序号	产品编码	产品名称	产品规格	数量	
1	ZX280RB	ZX280RB 乳房拉钩	195×120×25	1	把
2	ZX281RB	ZX281RB 乳房拉钩	195×100×25	1	把
3	ZX275RN	ZX275RN 乳房剥离器	220×30, 框型	1	把
4	ZX276RB	ZX276RB 乳房剥离器	415, 正弯, 铲形	1	把
5	ZX277RB	ZX277RB 乳房剥离器	400, 左弯, 铲形	1	把
6	ZX278RB	ZX278RB 乳房剥离器	400, 右弯, 铲形	1	把
7	ZX279RB	ZX279RB 乳房剥离器	260, U型, 铲形	1	把
8	ZX282RB	ZX282RB 乳房剥离器	350, 镰刀式	1	把
9	ZT031R	ZT031R 甲状腺拉钩	200, 一副, 带槽	1	把
10	ZC886RB	ZC886RB 组织剪	160, 弯, 镶片, 综合	1	把
11	ZC885RB	ZC885RB 组织剪	160, 直, 镶片, 综合	1	把
12	ZD678RN	ZD678RN 整形镊	120×0.8, 直, 有钩	1	把
13	ZD683RN	ZD683RN 整形镊	120×0.8, 直, 有齿	1	把
14	ZD047R	ZD047R 医用镊	140, 直	1	把
15	ZD870MB	ZD870MB 组织镊	160, 枪状, 带齿	1	把
16	ZH144R	ZH144R 止血钳	140, 直, 全齿	2	把
17	ZH145R	ZH145R 止血钳	140, 弯, 全齿	2	把
18	ZH243RN	ZH243RN 止血钳	160, 弯, 全齿, 精细	1	把
19	ZM013R	ZM013R 持针钳	125, 直, 细针, 镶片 0.3	1	把
20	ZM016R	ZM016R 持针钳	140, 直, 细针, 镶片 0.3	1	把
21	ZM033R	ZM033R 持针钳	160, 直, 细针, 镶片 0.3	1	把
22	ZE016R	ZE016R 组织钳	160, 直	2	把
23	ZE127R	ZE127R 海绵钳	250×10, 弯有齿	1	把
24	ZB073RN	ZB073RN 手术刀柄	3#	1	把
25	ZE433R	ZE433R 帕巾钳	140, 尖头	4	把

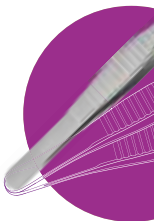

整形外科
Plastic Surgical Instruments

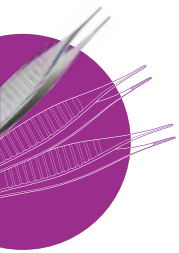

整形外科
Plastic Surgical Instruments



导引针 (悬吊针)
Guide pin

ZX274RB
140, 穿刺



分割刀
Plastic knife

ZX269RB
260, 横向



分割锯
Plastic saw

ZX270RB
265



铲刀
Scraper

ZX271RB
250, 弯, 降眉肌



分割刀
Plastic knife

ZX272RB
260, 左, 纵向
Left

分割刀
Plastic knife

ZX273RB
260, 右, 纵向
Right

剥离器
Raspatory

ZX267RB
230, 直, 额面
Straight

剥离器
Raspatory

ZX268RB
255, 弯, 额面
Curved

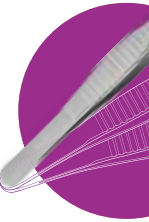

整形外科
Plastic Surgical Instruments

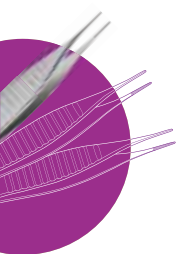

整形外科
Plastic Surgical Instruments



平骨凿
Chisel

- ★ ZK103RN
150×2, 平刃
- ★ ZK104RN
150×4, 平刃
- ZK105RN
150×6, 平刃
- ZK106RN
150×8, 平刃



半圆骨凿
Gouge

- ★ ZK107RN
150×3, 半圆
- ZK108RN
150×4, 半圆
- ZK109RN
150×5, 半圆



剥离器
Raspatory

- ZK950RN
200×3, 左向半圆切口, 肌腱
Left



剥离器
Raspatory

- ZK951RN
200×3, 右向半圆切口, 肌腱
Right



剥离器
Raspatory

- ZK961RN
250×4, 椭圆切口, 掌上肌腱
- ★ ZK962RN
250×6, 椭圆切口, 掌上肌腱



肌腱穿刺钳
Tendon puncture forceps

- ★ **ZK572RN**
140, 直尖, 带钩 Straight, sharp
- ★ **ZK573RN**
140, 弯尖, 带钩 Curved, sharp



肌腱夹持钳
Tendon holding forceps

- ★ **ZK574RN**
150, 双弯, 带钩



指骨剪
Finger scissors

- ★ **ZK480RB**
105 直尖
Straight/sharp
- ★ **ZK481RB**
105 弯尖
Curved/sharp



拉钩 (皮肤拉钩)
Retractor

- ★ **ZT171RN**
160×20×10, 手指
- ZT172RN**
160×30×15, 手指

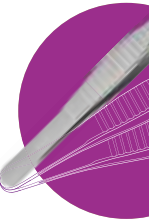

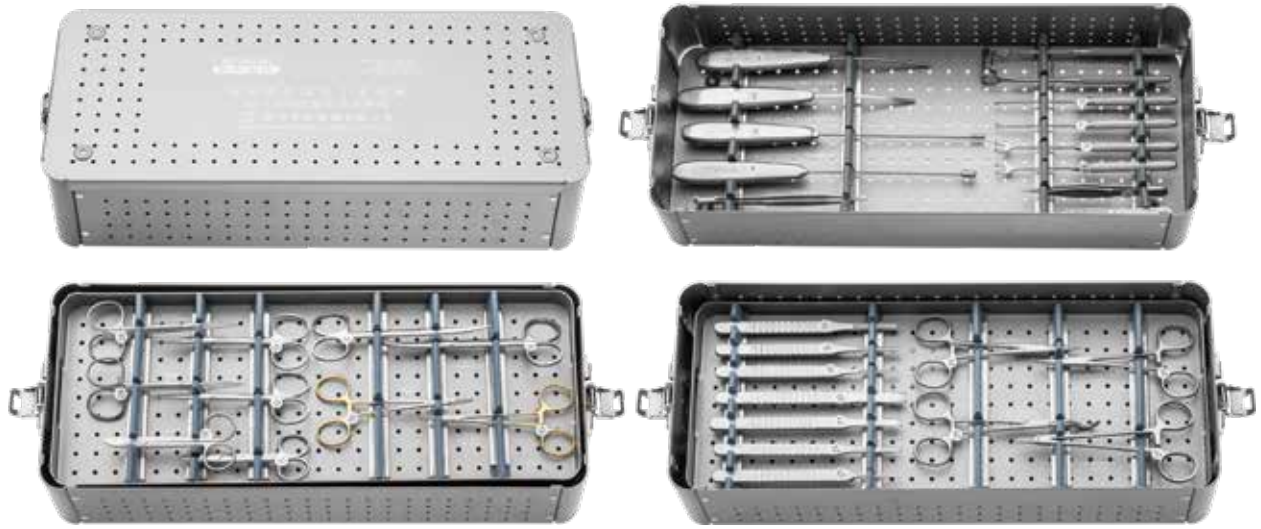

SZZ-I 型四肢整形手术器械 (ZX001)
SZZ-I arms and legs plastic instruments set

序号	产品编码	产品名称	产品规格	单位	数量
1	ZC692RB	精细剪	120, 直尖	把	1
2	ZC693RB	精细剪	120, 弯尖	把	1
3	ZC694RB	精细剪	120, 直圆	把	1
4	ZC695RB	精细剪	120, 弯圆	把	1
5	ZC696RB	精细剪	140, 弯圆窄	把	1
6	ZC697RB	精细剪	140, 弯圆宽	把	1
7	ZM013R	镶片持针钳	125, 直, 细针	把	2
8	ZM069RN	带剪持针钳	150	把	1
9	ZK480RB	骨剪	105, 直, 手指	把	1
10	ZK481RB	骨剪	105, 弯, 手指	把	1
11	ZD665RN	整形镊	120×0.6, 直有钩	把	2
12	ZD666RN	整形镊	120×0.6, 直平台	把	2
13	ZD667RN	整形镊	120, 无损伤	把	1
14	ZD669RN	整形镊	150, 直圆钩	把	1
15	ZK572RN	肌腱穿刺钳	140, 直尖, 带钩	把	1
16	ZK573RN	肌腱穿刺钳	140, 弯尖, 带钩	把	1
17	ZK574RN	肌腱夹持钳	150, 双弯, 带钩	把	1
18	ZK950RN	剥离器	200×3, 左向半圆切口, 肌腱	把	1
19	ZK951RN	剥离器	200×3, 右向半圆切口, 肌腱	把	1
20	ZK961RN	剥离器	250×4, 椭圆切口, 掌上肌腱	把	1
21	ZK962RN	剥离器	250×6, 椭圆切口, 掌上肌腱	把	1
22	ZT171RN	创口钩	160×20×10, 手指	把	1
23	ZT172RN	创口钩	160×30×15, 手指	把	1
24	ZO353RN	皮肤拉钩	150, 单齿, 锐	把	2
25	ZO354RN	皮肤拉钩	150, 双齿, 锐	把	2
26	ZK103RN	平骨凿	150×2, 平刃	把	1

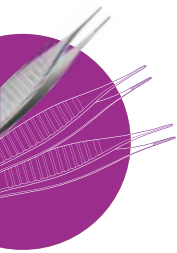

整形外科
Plastic Surgical Instruments

序号	产品编码	产品名称	产品规格	单位	数量
27	ZK104RN	平骨凿	150×4, 平刃	把	1
28	ZK105RN	平骨凿	150×6, 平刃	把	1
29	ZK106RN	平骨凿	150×8, 平刃	把	1
30	ZK107RN	圆骨凿	150×3, 半圆刃	把	1
31	ZK108RN	圆骨凿	150×4, 半圆刃	把	1
32	ZK109RN	圆骨凿	150×5, 半圆刃	把	1

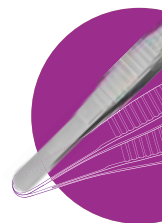



吸引管
Connector

ZX300R
转换器



吸引管
Suction tube tip

ZX301R
堵头



吸引管
Handle, with hole

ZX302R
手柄, 带孔



吸引管
Handle, without hole

ZX303R
手柄, 不带孔



吸引管
Shaft

ZX304R
拉杆, 20ml



吸引管 (螺旋口注水针)
Suction tube

ZX324R
φ1.0×100, 细孔

ZX325R
φ1.0×120, 细孔

ZX326R
φ1.2×70, 细孔

ZX327R
φ1.2×100, 细孔

ZX305R
φ1.2×120, 细孔

ZX328R
φ1.4×120, 细孔

ZX329R
φ1.5×150, 细孔

ZX330R
φ1.6×150, 细孔

ZX306R
φ1.8×200, 细孔

ZX331R
φ2.0×180, 细孔

ZX307R
φ2.0×250, 细孔

ZX332R
φ2.0×300, 细孔

ZX308R
φ2.5×300, 细孔

ZX333R
φ2.5×350, 细孔

ZX334R
φ3.0×350, 细孔

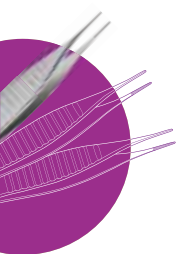



吸引管（螺旋口注脂针）
Suction tube / Injection needle

ZX335R
φ0.8×60, 单孔

ZX309R
φ1.0×60, 单孔

ZX336R
φ1.0×90, 单孔

ZX337R
φ1.2×50, 单孔

ZX310R
φ1.2×60, 单孔

ZX338R
φ1.2×70, 单孔

ZX311R
φ1.2×90, 单孔

ZX339R
φ1.2×100, 单孔

ZX340R
φ1.2×120, 单孔

ZX341R
φ1.4×80, 单孔

ZX342R
φ1.4×100, 单孔

ZX343R
φ1.4×120, 单孔

ZX344R
φ1.5×60, 单孔

ZX312R
φ1.5×90, 单孔

ZX313R
φ1.5×120, 单孔

ZX345R
φ1.6×100, 单孔

ZX346R
φ1.6×130, 单孔

ZX347R
φ1.6×150, 单孔

ZX348R
φ1.8×135, 单孔

ZX349R
φ1.8×150, 单孔

ZX350R
φ1.8×180, 单孔

ZX314R
φ2.0×150, 单孔

ZX315R
φ2.0×180, 单孔

ZX316R
φ2.0×200, 单孔

ZX351R
φ2.5×180, 单孔

ZX317R
φ2.5×200, 单孔



吸引管（螺旋口注脂针）
Suction tube / Injection needle

ZX352R
φ1.8×135, 双孔

ZX353R
φ1.8×150, 双孔

ZX354R
φ1.8×180, 双孔

ZX355R
φ2.0×150, 双孔

ZX356R
φ2.0×180, 双孔

ZX357R
φ2.0×200, 双孔

ZX358R
φ2.5×200, 双孔

ZX359R
φ3.0×250, 双孔

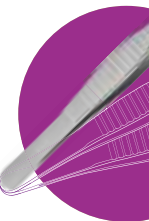



吸引管（螺旋口吸脂针）
Suction tube / Liposuction needle

ZX360R
φ1.8×150, 13孔, 斜孔

ZX361R
φ1.8×180, 13孔, 斜孔

ZX362R
φ1.8×200, 13孔, 斜孔

ZX318R
φ2.0×150, 16孔, 斜孔

ZX363R
φ2.0×180, 16孔, 斜孔

ZX364R
φ2.0×200, 16孔, 斜孔

ZX319R
φ2.5×200, 16孔, 斜孔

ZX365R
φ2.5×250, 16孔, 斜孔

ZX320R
φ2.5×300, 16孔, 斜孔

ZX366R
φ3.0×200, 24孔, 斜孔

ZX367R
φ3.0×250, 24孔, 斜孔

ZX368R
φ3.0×300, 24孔, 斜孔

ZX369R
φ3.0×350, 24孔, 斜孔

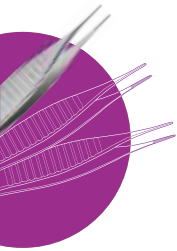

整形外科
Plastic Surgical Instruments



吸引管（螺旋口吸脂针）
Suction tube / Liposuction needle

ZX321R
φ2.5×250, 9孔, 长圆孔

ZX371R
φ2.5×300, 9孔, 长圆孔

ZX373R
φ3.0×250, 9孔, 长圆孔

ZX322R
φ3.0×300, 9孔, 长圆孔

ZX372R
φ3.0×350, 9孔, 长圆孔



吸引管（螺旋口注脂针）
Suction tube / Injection needle

ZX374R
φ1.8×100, 单孔, 扁形

ZX375R
φ1.8×150, 单孔, 扁形

ZX323R
φ1.8×180, 单孔, 扁形

ZX376R
φ2.0×100, 单孔, 扁形

ZX377R
φ2.0×150, 单孔, 扁形

ZX378R
φ2.0×180, 单孔, 扁形

ZX379R
φ2.0×200, 单孔, 扁形

脂肪移植器械
Liposuction instruments

序号	产品编码	产品名称	产品规格	数量
1	ZX300R	螺旋口转换器	转换器	2
2	ZX301R	螺旋口堵头	堵头	8
3	ZX302R	螺旋口手柄	手柄, 带孔	1
4	ZX303R	螺旋口手柄	手柄, 不带孔	1
5	ZX304R	注射器拉杆	拉杆, 20ml	1
6	ZX305R	注水针 (螺旋口)	φ1.2×120, 细孔	1
7	ZX306R	注水针 (螺旋口)	φ1.8×200, 细孔	1
8	ZX307R	注水针 (螺旋口)	φ2.0×250, 细孔	1
9	ZX308R	注水针 (螺旋口)	φ2.5×300, 细孔	1
10	ZX309R	注脂针 (螺旋口)	φ1.0×60, 单孔	1
11	ZX310R	注脂针 (螺旋口)	φ1.2×60, 单孔	1
12	ZX311R	注脂针 (螺旋口)	φ1.2×90, 单孔	1
13	ZX312R	注脂针 (螺旋口)	φ1.5×90, 单孔	1
14	ZX313R	注脂针 (螺旋口)	φ1.5×120, 单孔	1
15	ZX314R	注脂针 (螺旋口)	φ2.0×150, 单孔	1
16	ZX315R	注脂针 (螺旋口)	φ2.0×180, 单孔	1
17	ZX316R	注脂针 (螺旋口)	φ2.0×200, 单孔	1
18	ZX317R	注脂针 (螺旋口)	φ2.5×200, 单孔	1
19	ZX318R	吸脂针 (螺旋口)	φ2.0×150, 16孔, 斜孔	1
20	ZX319R	吸脂针 (螺旋口)	φ2.5×200, 16孔, 斜孔	1
21	ZX320R	吸脂针 (螺旋口)	φ2.5×300, 16孔, 斜孔	1
22	ZX321R	吸脂针 (螺旋口)	φ2.5×250, 9孔, 长圆孔	1
23	ZX322R	吸脂针 (螺旋口)	φ3.0×300, 9孔, 长圆孔	1
24	ZX323R	吸脂针 (螺旋口)	φ1.8×180, 单孔, 扁形	1

