

High quality Series
Ear, Nose and Throat Instruments
耳鼻喉科（精品系列）

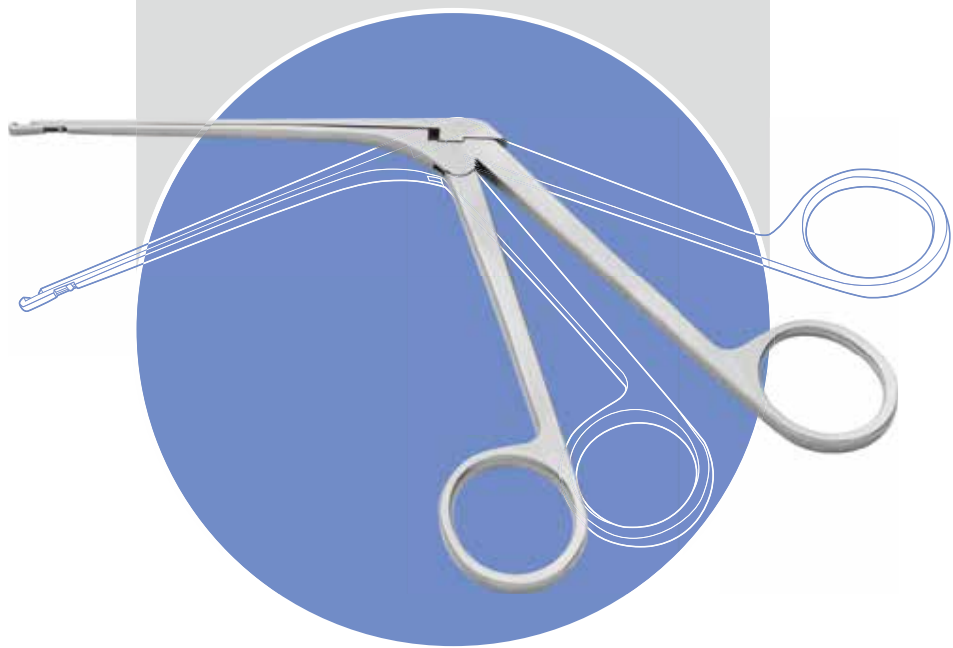

QUALITY
OUR WAY TO SUCCESS

Ear, Nose and Throat Instruments

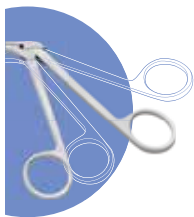
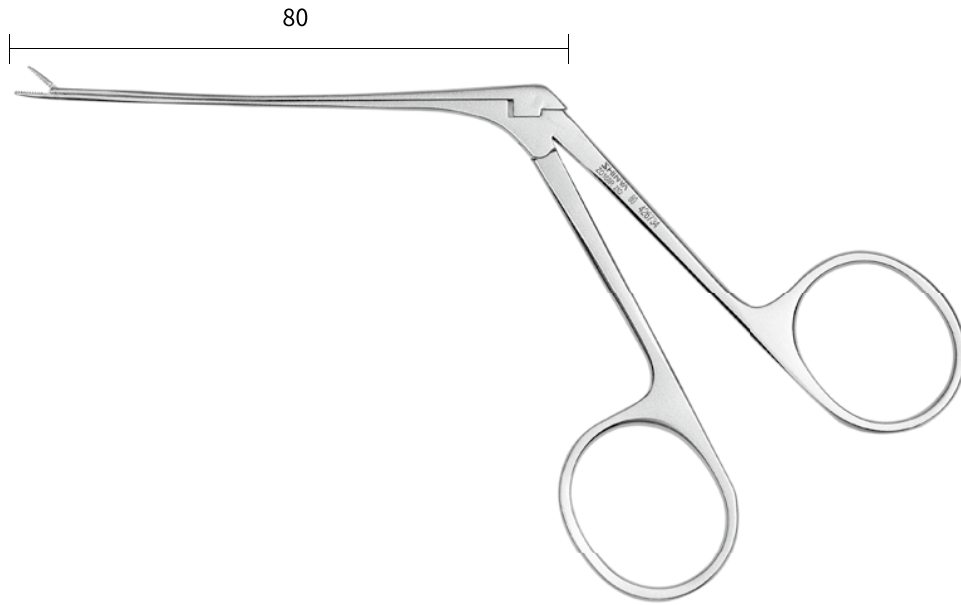

耳
鼻
喉
科
Ear, Nose and Throat Instruments



耳钳 Ear forceps
Z0886R
 80×1.2, 直, 碗形
Z0167R
 80×1.5, 直, 碗形
Z0253R
 80×2, 直, 碗形



耳钳 Ear forceps
Z0887R
 80×1.2×45°, 上弯, 碗形
Z0255R
 80×2.0×45°, 上弯, 碗形
Z0256R
 80×1.5×45°, 上弯, 碗形



耳钳 Ear forceps
Z03919RB
 80×1.2×45°, 下弯, 碗形



耳钳 Ear forceps
Z03917RB
 80×0.5, 直, 橄榄形
Z0166R
 80×0.8, 直, 橄榄形



耳钳 Ear forceps
Z0859R
 80×0.8×45°, 上弯, 橄榄形



耳钳 Ear forceps
Z0860R
 80×0.8×30°, 左弯, 橄榄形
 left curved



耳钳 Ear forceps
Z0861R
 80×0.8×30°, 右弯, 橄榄形
 right curved



耳钳 Ear forceps
Z03918RB
 80×3×30°, 下弯, 麦粒



耳钳 Ear forceps
Z0168R
 80×4, 直, 麦粒形
Z0888R
 80×3, 直, 麦粒形
Z0889R
 80×7, 直, 麦粒形



耳钳 Ear forceps
Z0257R
 80×3×45°, 上弯, 麦粒形



耳钳 Ear forceps
Z0270R
 80×3×30°, 左弯, 麦粒形
 left curved



耳钳 Ear forceps
Z0271R
 80×3×30°, 右弯, 麦粒形
 right curved



耳剪 **Z03820RB**
 80, 直
 ear scissors



耳剪 **Z03821RB**
 80, 左弯
 ear scissors, left curved



耳剪 **Z03822RB**
 80, 右弯
 ear scissors, right curved



耳剪 **Z03883RB**
 80, 上弯
 ear scissors

镫骨足弓剪
Stapes scissors



Z0173R 75 左上翘 left upward angled

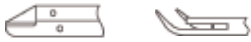

Z0174R 75 右上翘 left upward angled



镫骨钳(镫骨钳安装钳)
Stapes applying forceps



Z0169R 80



镫骨钳
Stapes applying forceps



Z0180R 75



耳用椎骨咬骨剪(锤骨咬骨剪)
Stapes scissors



Z0181R 80

Z0178R 110

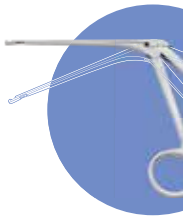

耳鼻喉科
Ear, Nose and Throat Instruments

160



ear hook



显微耳针
Z03931RB
 160, 弯型, 尖头
 sharp



显微耳针
Z03930RB
 160, 角弯, 25°, 钝头
 blunt



显微耳针
Z03929RB
 160, 角弯, 25°, 尖头
 sharp



显微耳针
Z03928RB
 160×0.4, 直型, 尖头
 sharp



显微耳针
Z03933RB
 160, 直型, 尖头
 sharp



显微耳针
Z03934RB
 160×0.6, 直型, 尖头
 sharp



耳钩
Z03935RB
 160×0.4, 直形,
 角弯90°, 钝钩
 sharp



耳钩
Z03921RB
 160×0.6, 直形,
 角弯90°, 钝钩
 sharp



耳钩
Z03936RB
 160×1, 直形,
 角弯90°, 锐钩
 sharp



耳钩
Z03937RB
 160×1.4, 直形,
 角弯90°, 锐钩
 sharp



耳钩
Z03938RB
 160×1.6, 直形,
 角弯90°, 锐钩
 sharp



耳钩
Z03939RB
 160×1.8, 直形,
 角弯90°, 锐钩
 sharp



耳钩
Z03903RB
 165×2, 直形, 锐钩
 sharp



耳钩
Z03965RB
 160×2.5, 直形,
 角弯90°, 锐钩
 sharp



耳钩
Z03966RB
 160×0.8, 直形,
 角弯45°, 锐钩
 sharp



耳钩
Z03922RB
 160×1, 直形,
 角弯45°, 锐钩
 sharp



耳钩
Z03967RB
 160×1.2, 直形,
 角弯45°, 锐钩
 sharp



耳钩
Z03968RB
 160×1.5, 直形,
 角弯45°, 锐钩
 sharp



耳钩
Z03969RB
 160×1.8, 直形,
 角弯45°, 锐钩
 sharp



耳钩
Z03970RB
 160×2, 直形,
 角弯45°, 锐钩
 sharp

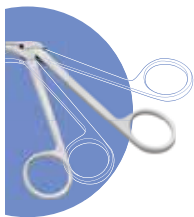

耳鼻喉科
 Ear, Nose and Throat Instruments

160



耳用探针
ZO3927RB
160×0.8, 角弯, 25°, 球头
ear hook



耳用探针
ZO3926RB
160×0.8, 弯, 球头
ear hook



耳用探针
ZO3977RB
160×0.8, 直型, 球头
ear hook



剥离器 dissector
ZO3971RB
160, 1.2×15°, 角弯



剥离器 dissector
ZO3925RB
160, 1.5×15°, 角弯



剥离器 dissector
ZO3923RB
160×1.5, 微弯



剥离器 dissector
ZO3972RB
160×1.8, 弯头



剥离器 dissector
ZO3973RB
160×2, 微弯



剥离器 dissector
ZO3974RB
160×3, 微弯



剥离器 dissector
ZO3975RB
160, 1.2×45°, 左弯, 耳开窗
left curved



剥离器 dissector
ZO3976RB
160, 1.2×45°, 右弯, 耳开窗
right curved



剥离器 dissector
ZO3924RB
160, 1.2×70°, 左弯
left curved



剥离器 dissector
ZO3932RB
160, 1.2×70°, 右弯
right curved



耳用骨凿 gouge
ZO3978RB
160×2×1.4, 直, 圆刃

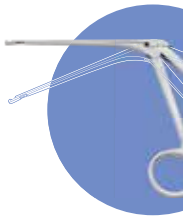

耳鼻喉科
Ear, Nose and Throat Instruments

160

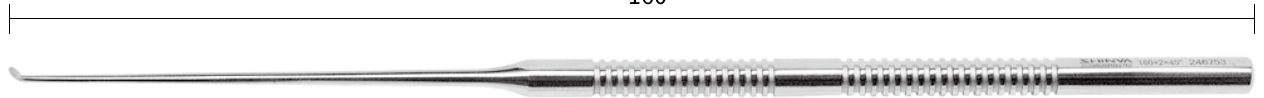

ear flap knife



耳道皮瓣刀
ZO3801RB
 160×1×45°,角弯



耳道皮瓣刀
ZO3802RB
 160×1.2×45°,角弯



耳道皮瓣刀
ZO3803RB
 160×1.5×45°,角弯



耳道皮瓣刀
ZO3804RB
 160×1.8×45°,角弯



耳道皮瓣刀
ZO3805RB
 160×2×45°,角弯



耳道皮瓣刀
ZO3806RB
 160×2.5×45°,角弯



耳道皮瓣刀
ZO3807RB
 160×3×45°,角弯



耳道皮瓣刀
ZO3808RB
 160×1×90°,角弯



耳道皮瓣刀
ZO3809RB
 160×1.2×90°,角弯



耳道皮瓣刀
ZO3810RB
 160×1.5×90°,角弯



耳道皮瓣刀
ZO3811RB
 160×1.8×90°,角弯



耳道皮瓣刀
ZO3812RB
 160×2×90°,角弯



耳道皮瓣刀
ZO3813RB
 160×2.5×90°,角弯



耳道皮瓣刀
ZO3814RB
 160×2,直型



耳道皮瓣刀
ZO3815RB
 160×2.5,直型



耳道皮瓣刀
ZO3816RB
 160,镰状



耳道皮瓣刀
ZO3817RB
 160,镰状

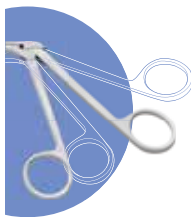

耳鼻喉科
 Ear, Nose and Throat Instruments

75

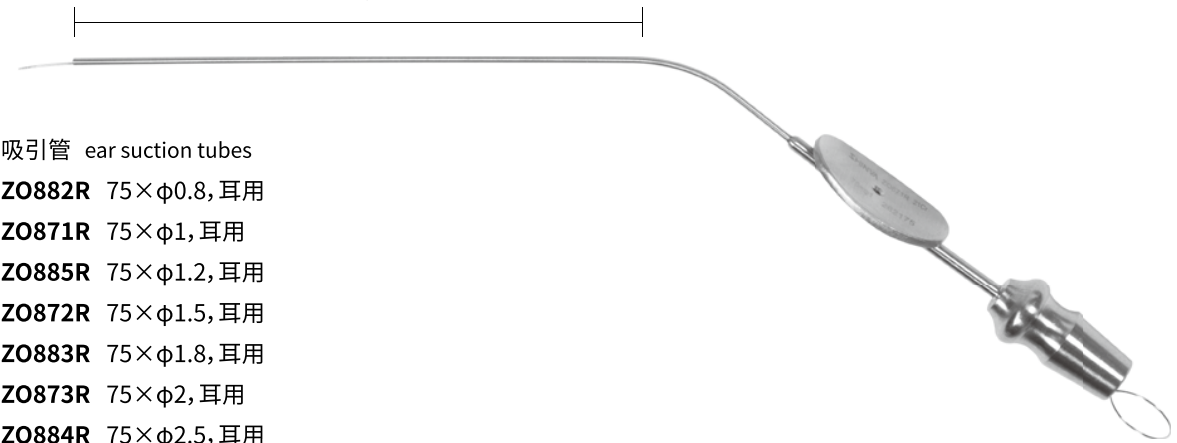

吸引管 ear suction tubes

ZO882R 75×φ0.8,耳用

ZO871R 75×φ1,耳用

ZO885R 75×φ1.2,耳用

ZO872R 75×φ1.5,耳用

ZO883R 75×φ1.8,耳用

ZO873R 75×φ2,耳用

ZO884R 75×φ2.5,耳用



耳用叉 ear fork

Z03819RN 200, T型, 于宾格、美敦力T型管通用

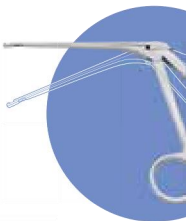
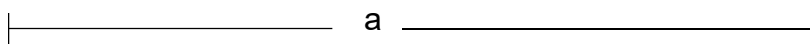

耳鼻喉科
 Ear, Nose and Throat Instruments



鼻组织钳 a
Z03661RB 130×3.5,
 管式, 左弯, 尖头



鼻组织钳 a
Z03662RB 130×3.5,
 管式, 右弯, 尖头



鼻组织钳 a
Z03701RB 160×3.5,
 管式, 直, 尖头



鼻组织钳 a
Z03702RB 160×3.5×45°,
 管式, 角弯, 尖头



鼻组织钳 a
Z03640RB 130×3.5,
 管式, 直, 尖头



鼻组织钳 a
Z03641RB 130×3.5×30°,
 管式, 角弯, 尖头



鼻组织钳 a
Z03642RB 130×3.5×45°,
 管式, 角弯, 尖头

nasal tissue forceps

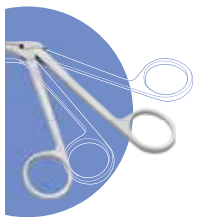

耳鼻喉科
 Ear, Nose and Throat Instruments

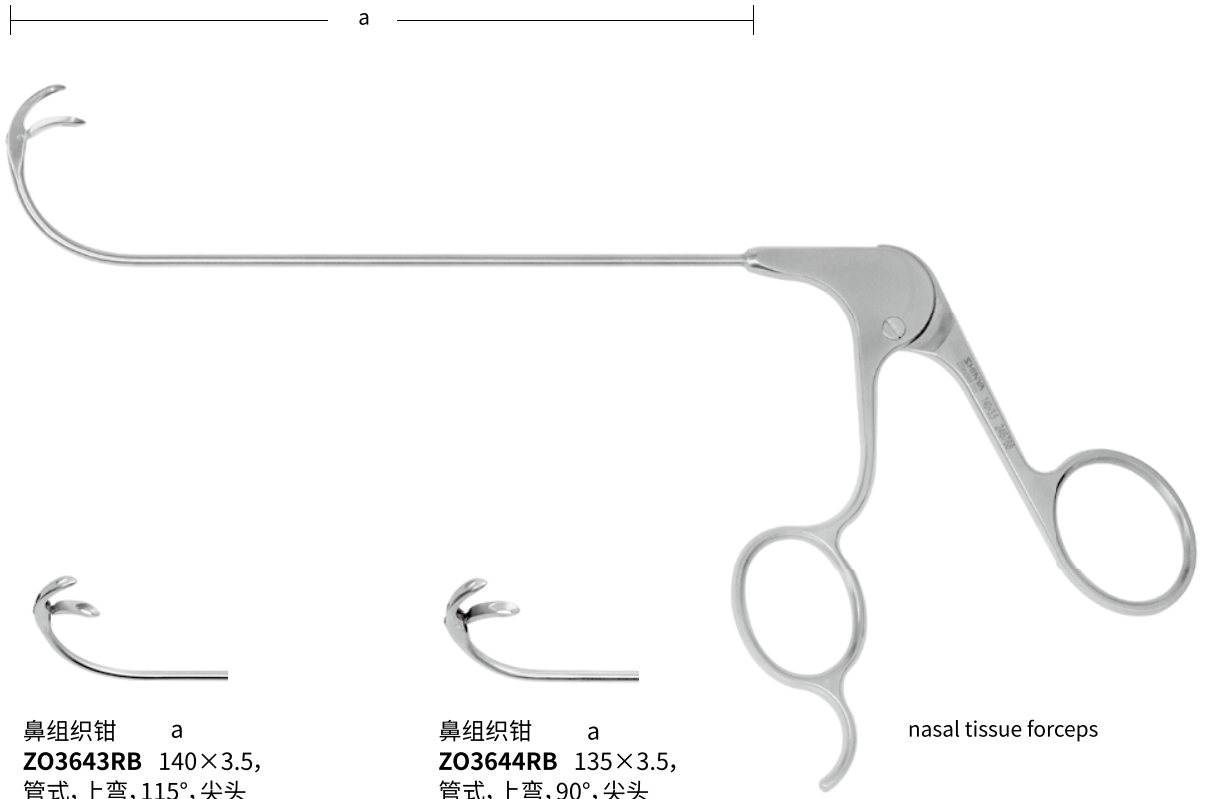

nasal tissue forceps



鼻组织钳 a
ZO3643RB 140×3.5,
 管式, 上弯, 115°, 尖头



鼻组织钳 a
ZO3644RB 135×3.5,
 管式, 上弯, 90°, 尖头



鼻组织钳 a
ZO3645RB 140×3.5,
 管式, 下弯, 115°, 尖头



鼻组织钳 a
ZO3646RB 135×3.5,
 管式, 下弯, 90°, 尖头



鼻咬切钳 a
ZF3010RB 180×φ3.5,
 直形, 蝶窦口
 nasal cutting forceps



鼻咬切钳 a
ZF3012RB 170×φ3.5×65°,
 蝶窦口
 nasal cutting forceps



nasal cutting forceps



鼻咬切钳
Z03659RB
130×3.5,
管式, 左弯, 尖头



鼻咬切钳
Z03660RB
130×3.5,
管式, 右弯, 尖头



鼻咬切钳
Z03647RB
130×3,
管式, 直型, 尖头



鼻咬切钳
Z03648RB
130×3×30°,
管式, 角弯, 尖头



鼻咬切钳
Z03649RB
130×3×45°,
管式, 角弯, 尖头



鼻咬切钳
Z03650RB
130×3,
管式, 直型, 长圆头



鼻咬切钳
Z03651RB
130×3×30°,
管式, 角弯, 长圆头



鼻咬切钳
Z03652RB
130×3×45°,
管式, 角弯, 长圆头



鼻咬切钳
Z03653RB
130×1.8,
管式, 直型, 反切



鼻咬切钳
Z03654RB
130×2.5,
管式, 直型, 反切



鼻组织剪
Z03655RB
130, 直形, 管式
nasal tissue scissors



鼻组织剪
Z03656RB
130, 左弯, 管式
nasal tissue scissors
left curved



鼻组织剪
Z03657RB
130, 右弯, 管式
nasal tissue scissors
right curved



耳鼻喉科
Ear, Nose and Throat Instruments



蝶窦咬骨钳
Z03944RB
 170×70°×3
 nasal cutting forceps



蝶窦咬骨钳
Z03943RB
 170×30°×3
 nasal cutting forceps

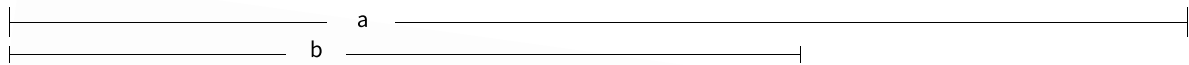

鼻腔吸引管 (门诊治疗台专用)
 suction tube for outpatient use

	a	b
Z01280RB	155×Φ1.5×30°×55	工作长度 100
Z01281RB	155×Φ2×30°×55	工作长度 100
Z01282RB	155×Φ2.5×30°×55	工作长度 100
Z01283RB	155×Φ3×30°×55	工作长度 100
Z01284RB	155×Φ3.5×30°×55	工作长度 100

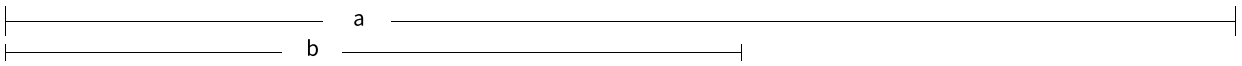

鼻腔吸引管
 suction tube

	a	b
Z03835RB	170×Φ2.5	工作长度 110
Z03836RB	170×Φ3	工作长度 110
Z03837RB	170×Φ3.5	工作长度 110

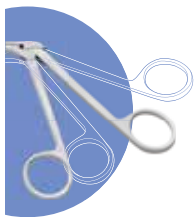

耳鼻喉科
 Ear, Nose and Throat Instruments

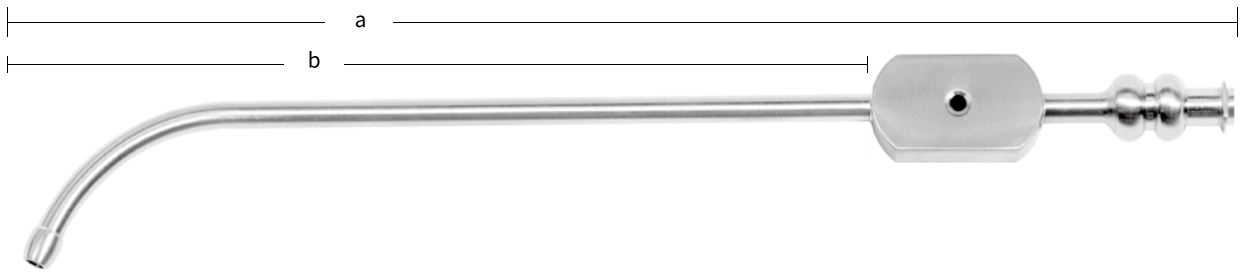

鼻腔吸引管
 suction tube

	a	b		a	b		
ZO3838RB	175×φ2.5×60°	平口	工作长度 120	ZO3839RB	175×φ3×60°	平口	工作长度 120
ZO3840RB	175×φ3.5×60°	平口	工作长度 120	ZO3841RB	175×φ4×60°	平口	工作长度 120

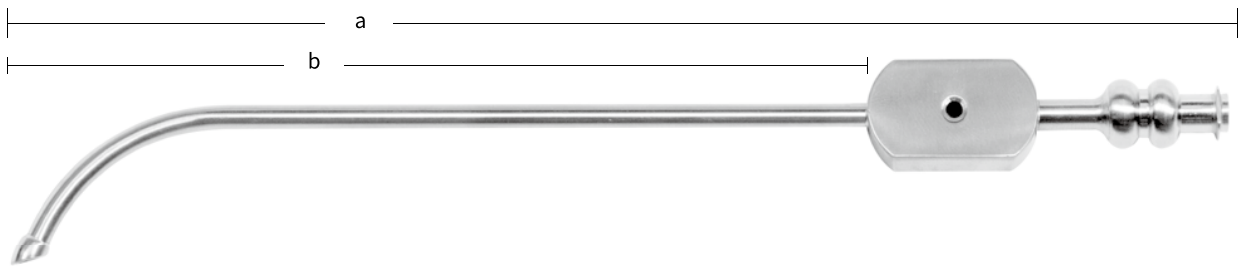

鼻腔吸引管
 suction tube

	a	b		a	b		
ZO3842RB	175×φ2.5×60°	斜口	工作长度 120	ZO3843RB	175×φ3×60°	斜口	工作长度 120
ZO3844RB	175×φ3.5×60°	斜口	工作长度 120	ZO3845RB	175×φ4×60°	斜口	工作长度 120

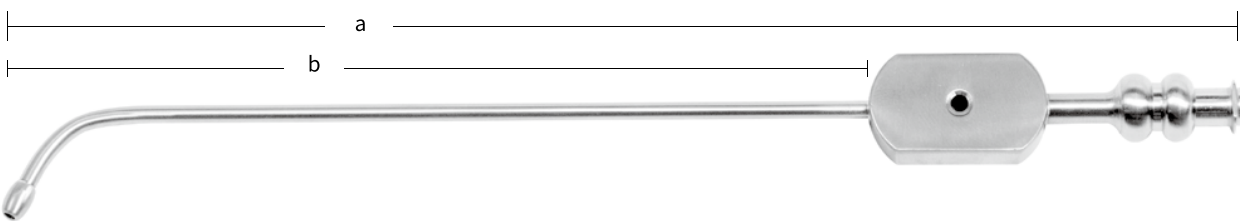

鼻腔吸引管
 suction tube

	a	b		a	b		
ZO3858RB	175×φ2.5×70°	平口	工作长度 120	ZO3859RB	175×φ3×70°	平口	工作长度 120
ZO3860RB	175×φ3.5×70°	平口	工作长度 120	ZO3861RB	175×φ4×70°	平口	工作长度 120

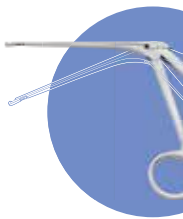

耳鼻喉科
 Ear, Nose and Throat Instruments



鼻腔吸引管
 suction tube

	a	b
ZO3862RB	175×φ2.5×90° 平口	工作长度 120
ZO3863RB	175×φ3×90° 平口	工作长度 120
ZO3864RB	175×φ3.5×90° 平口	工作长度 120
ZO3865RB	175×φ4×90° 平口	工作长度 120

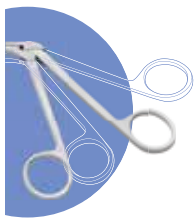

耳鼻喉科
 Ear, Nose and Throat Instruments



剥离器
 dissector with suction connector

ZO3866RB	200×3, 单面孔, 带吸引, 旋转, 45°
ZO3867RB	200×3.8, 单面孔, 带吸引, 旋转, 45°

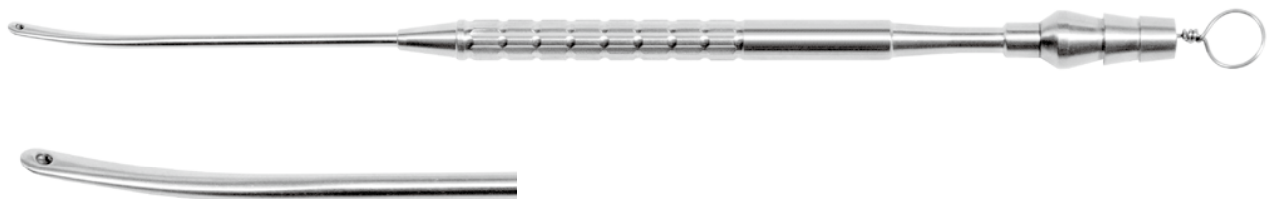

剥离器
 dissector with suction connector

ZO3868RB	200×3, 单面孔, 带吸引, 旋转, 0°
ZO3869RB	200×3.8, 单面孔, 带吸引, 旋转, 0°



剥离器
dissector with suction

ZO628RN 215×2.5×45°,带吸引

ZO1020RN 215×2.5×60°,带吸引

ZO1019RN 215×2.5×90°,带吸引



鼻腔拉钩(鼻腔异物钩圈)
nasal foreign body retractor

ZO629RN 180, 双头



上颌窦探针
nasal probe

ZO439RN 190×1×2, 角弯



上颌窦探针
nasal probe

ZO627RN 210×1.5×1.5, 角弯



耳鼻喉科
Ear, Nose and Throat Instruments



鼻骨膜剥离器
Nasal elevator

ZO4020RB 200×3×3, 双头 double ended, blunt



鼻骨膜剥离器
Nasal elevator

ZO4021RB 200×2.5×2.5, 双头
one end sharp, the other end semi-sharp



鼻骨膜剥离器
Nasal elevator

ZO4026RB 200×3.5×3.5, 双头 straight/curved,blunt
ZO4023RB 200×4.5×4.5, 双头 straight/curved,blunt



鼻骨膜剥离器
Nasal elevator

ZO4018RB 200×3.5×3.5, 双头
one end sharp, the other end semi-sharp

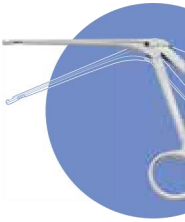

耳鼻喉科
Ear, Nose and Throat Instruments



吸引管
suction tube

ZO4024RB 180, 弯, 斜孔 (左弯)(left curved)
ZO4025RB 180, 弯, 斜孔 (右弯) (right curved)



鼻骨膜剥离器
dissector with suction

ZO4019RB 200×3.5×2.5, 双头
one end sharp cutting, the other semi-sharp



鼻骨膜剥离器
dissector with suction

ZO4022RB 200×2.5×2.5, 双头
one end sharp cutting, the other semi-sharp



鼻黏膜刀
Nasal knife

ZO4017RB 195×3.5×4.5, 双头
both ends sharp cutting



耳鼻喉科
Ear, Nose and Throat Instruments

Special Instruments for Ear Clinics



剥离器
Ear dissector

ZO4007RB 155×2.2×1.8, 双头



盯聆钩
cerumen hook

ZO4006RB 160×2×2.4, 双头

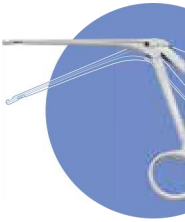

耳鼻喉科
Ear, Nose and Throat Instruments



卷棉子
Cotton carrier for ear clinic

ZO4008RB 160×Φ0.5, 直



剥离器
Ear curette

ZO4009RB 160, 耳用



显微喉钳
 Laryngeal forceps



显微喉钳
JO1180RB
 230×Φ2,管式,直型,圆头
JO4030RB
 230×Φ2.5,管式,直型,圆头



显微喉钳
JO1181RB
 230×Φ2,管式,上弯,圆头
JO4031RB
 230×Φ2.5,管式,上弯,圆头



显微喉钳
JO1182RB
 230×Φ2,管式,
 右弯,圆头 Right curved
JO4032RB
 230×Φ2.5,管式,
 右弯,圆头



显微喉钳
JO1183RB
 230×Φ2,管式,
 左弯,圆头 left curved
JO4033RB
 230×Φ2.5,管式,
 右弯,圆头



显微喉钳
JO1184RB
 230×1,管式,
 直型,麦粒形



显微喉钳
JO1185RB
 230×1,管式,
 右弯,麦粒形 Right curved



显微喉钳
JO1186RB
 230×1,管式,
 左弯,麦粒形 Left curved



显微喉钳
JO1187RB
 230×1,管式,
 上弯,麦粒形



显微喉钳
JO1188RB
 230×3,管式,角弯,
 右弯,抓取型 Right curved
JO1189RB
 230×2,管式,角弯,
 右弯,抓取型 Right curved



显微喉钳
JO1190RB
 230×3,管式,角弯,
 左弯,抓取型 Left curved
JO1191RB
 230×2,管式,角弯,
 左弯,抓取型 Left curved



显微持针钳
JO1192RB
 230,直型,自锁
 Needle holder' self-locking



显微喉剪
 laryngeal scissors
JO1249RB
 230,管式,直型
 Laryngeal scissors



显微喉剪
 laryngeal scissors
JO1250RB
 230×45°,管式,上弯
 Laryngeal scissors



显微喉剪
 laryngeal scissors
JO1251RB
 230×15°,管式,上弯
 Laryngeal scissors



显微喉剪
 laryngeal scissors
JO1252RB
 230,管式,右弯
 Laryngeal scissors'
 right curved



显微喉剪
 laryngeal scissors
JO1253RB
 230,管式,左弯
 Laryngeal scissors'
 left curved

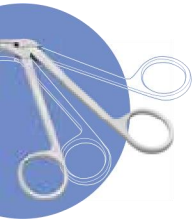

耳鼻喉科
 Ear, Nose and Throat Instruments



显微喉钳
 Laryngeal forceps



显微喉钳
ZO3823RB
 230×φ2, 管式, 直型, 圆头



显微喉钳
ZO3824RB
 230×φ2, 管式, 上弯, 圆头



显微喉钳
ZO3825RB
 230×φ2, 管式, 左弯, 圆头
 left curved



显微喉钳
ZO3826RB
 230×φ2, 管式, 右弯, 圆头
 right curved



显微喉钳
ZO3827RB
 230×2, 管式, 直型, 有齿



显微喉钳
ZO3828RB
 230×2, 管式, 上弯, 45°, 有齿



显微喉钳
ZO3829RB
 230×2, 管式, 直型, 三角头



显微喉钳
ZO3830RB
 230×2, 管式, 上弯, 45°, 三角头



显微喉钳
ZO3831RB
 230×2, 管式, 直型, 卵圆头



显微喉钳
ZO3832RB
 230×2, 管式, 上弯, 卵圆头



显微喉钳
ZO3833RB
 230×2, 管式, 左弯, 卵圆头
 left curved



显微喉钳
ZO3834RB
 230×2, 管式, 右弯, 卵圆头
 right curved



显微喉剪
 laryngeal scissors
ZO1241RB
 250×φ2, 管式, 直型
 laryngeal scissors



显微喉剪
 laryngeal scissors
ZO1242RB
 250×φ2, 管式, 上弯45°



显微喉剪
 laryngeal scissors
ZO1243RB
 250×φ2, 管式, 右弯
 right curved



显微喉剪
 laryngeal scissors
ZO1244RB
 250×φ2, 管式, 左弯
 left curved

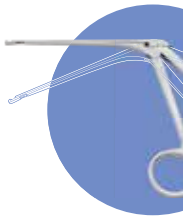

耳鼻喉科
 Ear, Nose and Throat Instruments



支撑喉镜支撑架
Laryngoscope frame
Z01227RN 支撑架

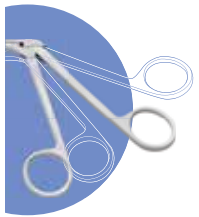

耳鼻喉科
Ear, Nose and Throat Instruments



支撑喉镜支撑架
Laryngoscope frame
Z01201RN 支撑架



支撑喉镜
Laryngoscope

ZO1228RN 大号, 带光纤 Large with optical fiber
ZO1229RN 小号, 带光纤 Small with optical fiber



支撑喉镜
Laryngoscope

ZO1202RN 大号 Large
ZO1203RN 小号 Small



支撑喉镜灯芯
Light insert for laryngoscope

ZO1221RN 带光纤 With optical fiber

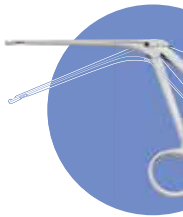

耳鼻喉科
Ear, Nose and Throat Instruments

支撑喉镜

Laryngoscope, adjustable

ZO1224RN 可调式

该产品为可调式支撑喉镜,由支撑架、喉镜、灯芯组成,供耳鼻喉科医生检查和治疗喉内病变。可调式支撑喉镜在使用过程中可以通过调节旋转手柄实现喉镜在支撑杆方向上的移动以及喉镜开口的调整,从而灵活的根据手术情况调整手术视野,方便医生操作。

Consists of frame, laryngoscope and light insert for ENT surgeons to check and make disease treatment. Laryngoscope and its opening can be moved and adjusted through adjusting the handle according to surgical requirement.

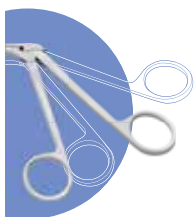

耳鼻喉科
Ear, Nose and Throat Instruments



显微喉刀 **ZO3846RB**
245, 直形, 镰刀
laryngeal knife

显微喉刀 **ZO3847RB**
245, 直形, 三角刃
laryngeal knife

显微喉刀 **ZO3848RB**
245, 直形, 圆刃
laryngeal knife

显微喉刀 **ZO3849RB**
245, 角弯, 圆刃
laryngeal knife

显微喉刀 **ZO3850RB**
245, 直形, 圆刃
laryngeal knife

显微喉钩 **ZO3851RB**
245, 圆弯
laryngeal hook

显微剥离器 **ZO3852RB**
245, 圆头, 微弯
laryngeal dissector

打结器 **ZO3853RB**
245
knot pusher

显微喉针 **ZO3854RB**
245, 直型, 球头
laryngeal needle

显微喉针 **ZO3855RB**
245, 角弯, 45°, 球头
laryngeal needle

显微喉针 **ZO3856RB**
245, 角弯, 90°, 球头
laryngeal needle

handle
喉显微手术器械手柄
ZO3857RB 与喉钩、
喉刀、喉针配用, 可换



吸引管
suction tube

	a	工作长度	b
ZO3870RN	250×Φ2.5, 弯, 喉用, 可控	205	205
ZO1270RN	250×Φ3, 弯, 喉用, 可控	205	205
ZO1271RN	250×Φ3.5, 弯, 喉用, 可控	205	205
ZO1272RN	250×Φ4, 弯, 喉用, 可控	205	205

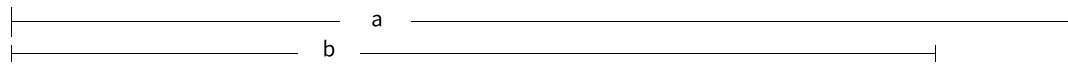

吸引管
suction tube

	a	工作长度	b
ZO1276RN	275×Φ2.5, 弯, 喉用, 可控	230	230
ZO1277RN	275×Φ3, 弯, 喉用, 可控	230	230
ZO1278RN	275×Φ3.5, 弯, 喉用, 可控	230	230
ZO1279RN	275×Φ4, 弯, 喉用, 可控	230	230

耳鼻喉科
Ear, Nose and Throat Instruments

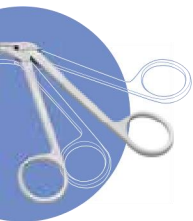

耳鼻喉科
 Ear, Nose and Throat Instruments

口腔开口器(成套)
 Mouth gag for surgical robots
ZR845RN 框式

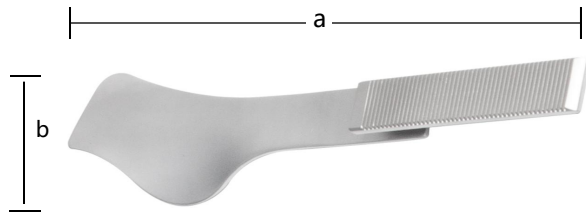
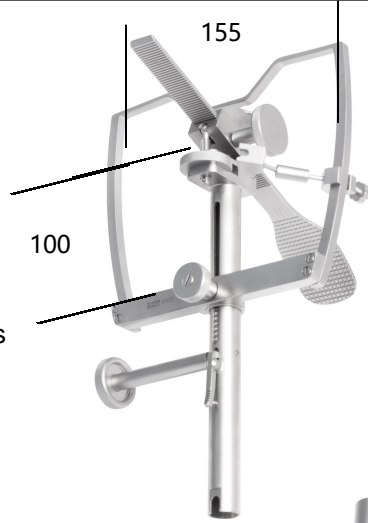

a b
 压舌板 207×47.5 (左)
 Tongue Spatula(left)

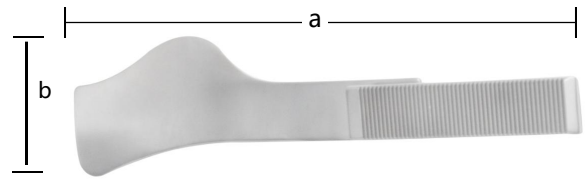

a b
 压舌板 207×47.5 (右)
 Tongue Spatula(right)

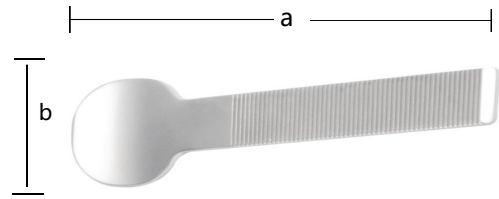

a b
 压舌板 150×34
 Tongue spatula

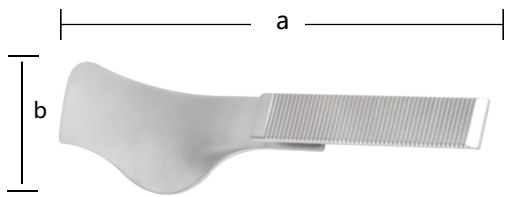

a b
 压舌板 173×47.5 (左)
 Tongue Spatula(left)

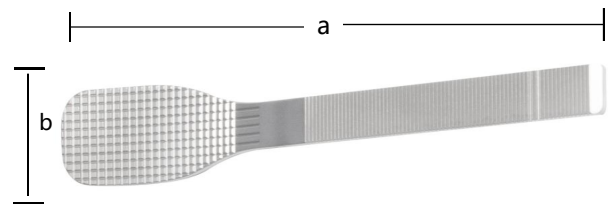

a b
 压舌板 215×35
 Tongue spatula

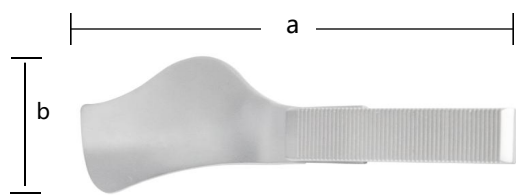

a b
 压舌板 173×47.5 (右)
 Tongue Spatula(right)

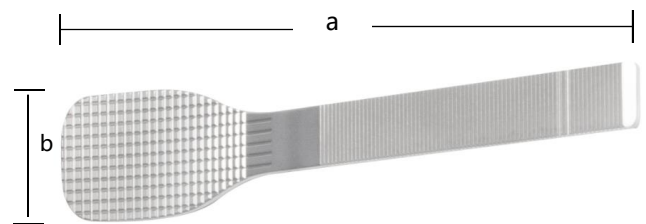

a b
 压舌板 215×40
 Tongue spatula

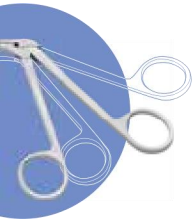

耳鼻喉科
 Ear, Nose and Throat Instruments



口腔开口器(成套)
 mouth gag(set)

	a	b	
ZR828RN 左式, 麻醉, 成人 (不带导光夹)	85	78	left, for adult
ZR826RN 左式, 麻醉, 小儿 (不带导光夹)	78	71	left, for children



Mouth gag with light guide(set),left

ZR843RN 左式, 麻醉, 成人 (带导光夹)	for adult
ZR846RN 左式, 麻醉, 小儿 (带导光夹)	for Children



口腔开口器(成套)
 mouth gag(set)

	a	b	
ZR827RN 右式, 麻醉, 成人 (不带导光夹)	85	78	right, for adult
ZR829RN 右式, 麻醉, 小儿 (不带导光夹)	78	71	right, for children

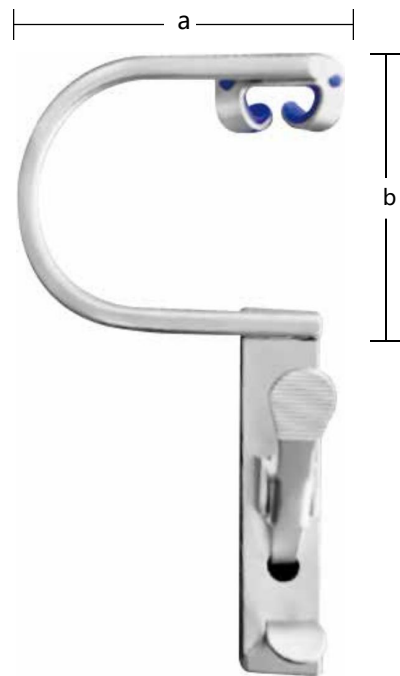

Mouth gag with light guide(set),right

ZR844RN 右式, 麻醉, 成人 (带导光夹)	for adult
ZR847RN 右式, 麻醉, 小儿 (带导光夹)	for Children

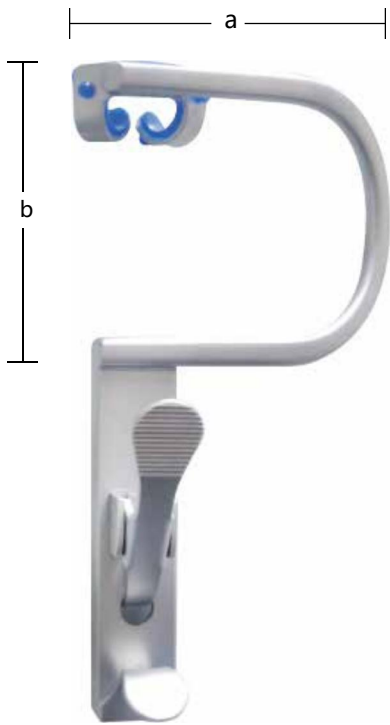

口腔开口器(框架)

mouth gag(set)		a	b	
ZR824RN	左式, 麻醉, 成人	85	78	left, for adult
ZR839RN	左式, 麻醉, 小儿	78	71	left, for children

口腔开口器(框架)

mouth gag(set)		a	b	
ZR825RN	右式, 麻醉, 成人	85	78	right, for adult
ZR840RN	右式, 麻醉, 小儿	78	71	right, for children



耳鼻喉科
 Ear, Nose and Throat Instruments



口腔开口器

mouth gag
ZR819RN 右式, 麻醉 right

口腔开口器

mouth gag
ZR820RN 左式, 麻醉 left

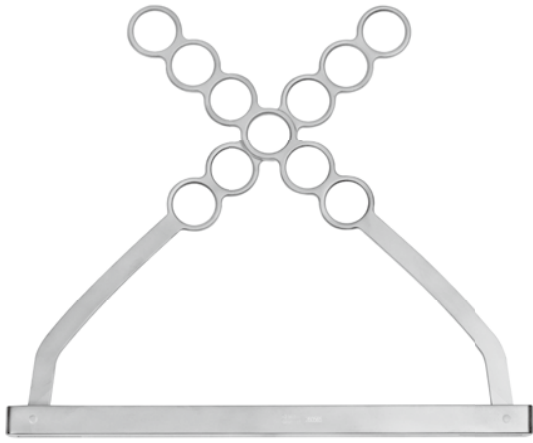

口腔开口器
Mouth gag support
ZR817T 开口器支架



口腔开口器
Mouth gag
ZR823RN 框式



口腔开口器
Mouth gag
ZR818RN 框式

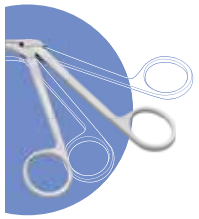

耳鼻喉科
Ear, Nose and Throat Instruments

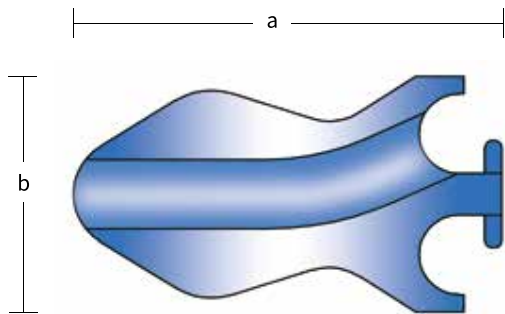

拉钩 retractor		a	b
ZR830RN 口腔	1#	深度62mm	宽度30mm
	2#	深度74mm	宽度34mm
	3#	深度78mm	宽度36mm

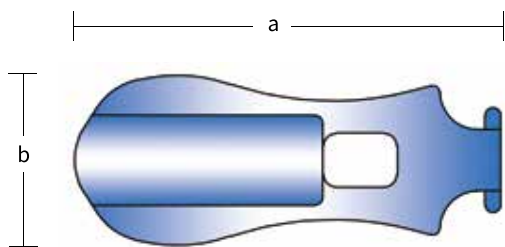

拉钩 retractor		a	b
ZR831RN 口腔	1#	深度63mm	宽度25mm
	2#	深度67mm	宽度30mm
	3#	深度80mm	宽度34mm

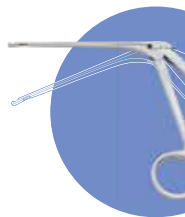
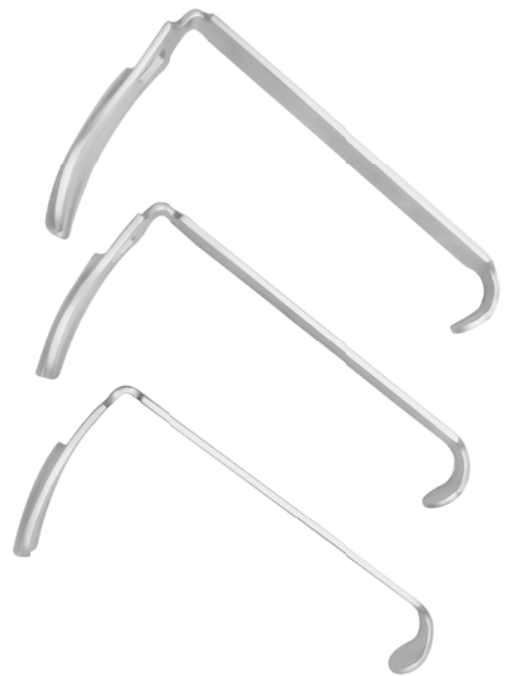

耳鼻喉科
 Ear, Nose and Throat Instruments

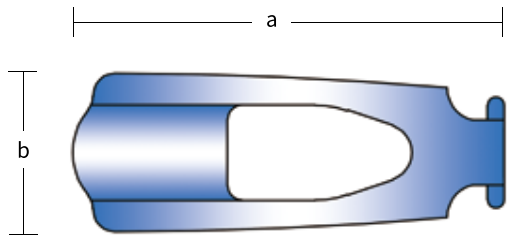

拉钩 retractor	a	b
ZR832RN 口腔	1# 深度60mm	宽度22mm
	2# 深度70mm	宽度26mm
	3# 深度80mm	宽度30mm
	4# 深度90mm	宽度32mm
	5# 深度100mm	宽度35mm

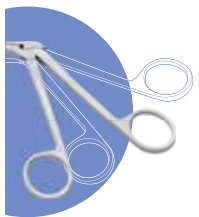

耳鼻喉科
 Ear, Nose and Throat Instruments

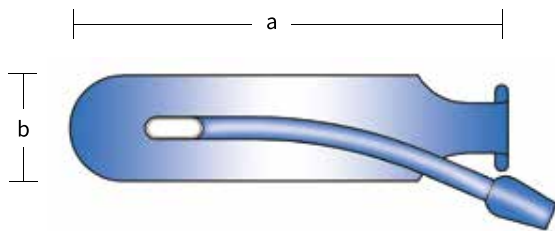

拉钩 retractor	a	b
ZR834RN 口腔	1# 深度40mm	宽度18mm
	2# 深度79mm	宽度19mm
	3# 深度85mm	宽度25mm
	4# 深度90mm	宽度25mm
	5# 深度96mm	宽度25mm



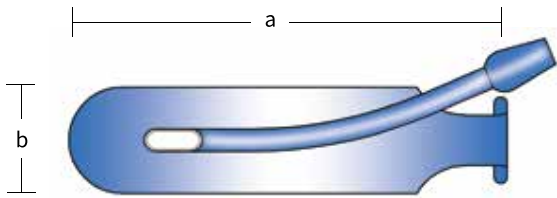

拉钩 retractor	a	b
ZR835RN 口腔	1# 深度40mm	宽度18mm
	2# 深度79mm	宽度19mm
	3# 深度85mm	宽度25mm
	4# 深度90mm	宽度25mm
	5# 深度96mm	宽度25mm

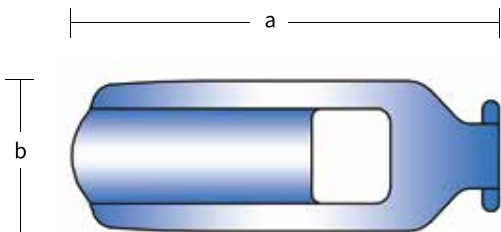

拉钩 retractor	a	b
ZR836RN 口腔	1# 深度60mm	宽度21mm
	2# 深度70mm	宽度25mm
	3# 深度80mm	宽度27mm
	4# 深度90mm	宽度29mm
	5# 深度50mm	宽度21mm

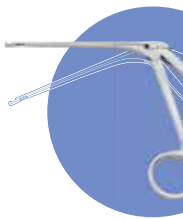

耳鼻喉科
 Ear, Nose and Throat Instruments

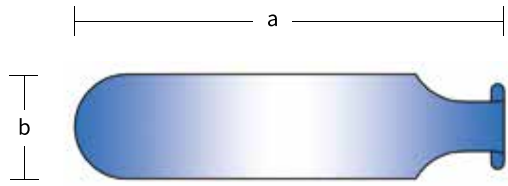

拉钩 retractor	a	b
ZR837RN 口腔	1# 深度40mm	宽度18mm
	2# 深度79mm	宽度19mm
	3# 深度85mm	宽度25mm
	4# 深度90mm	宽度25mm
	5# 深度96mm	宽度25mm

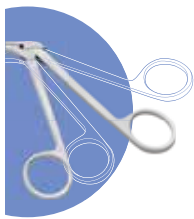
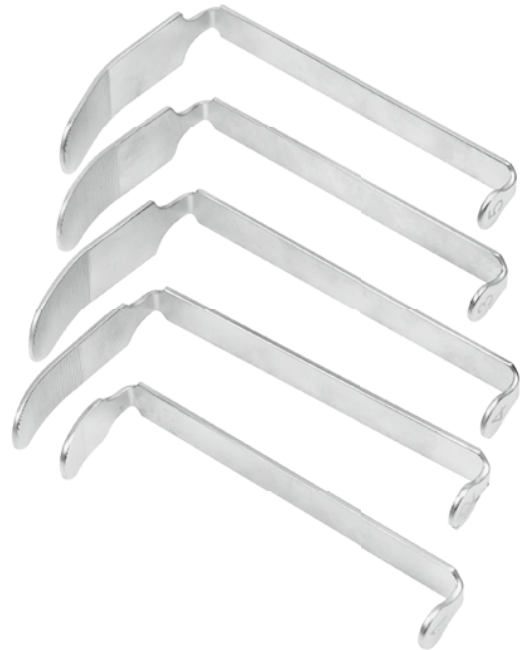

耳鼻喉科
 Ear, Nose and Throat Instruments

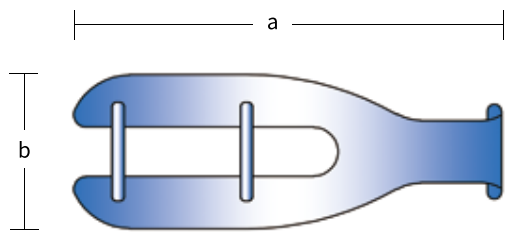

拉钩 retractor	a	b
ZR838RN 口腔	1# 深度70mm	宽度25mm
	2# 深度80mm	宽度26mm
	3# 深度90mm	宽度26mm
	4# 深度100mm	宽度26mm



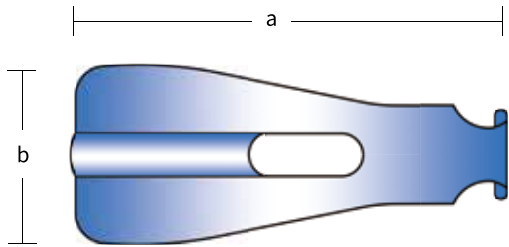

拉钩 retractor	a	b
ZR841RN 口腔	1# 深度110mm	宽度38mm
	2# 深度100mm	宽度37mm
	3# 深度90mm	宽度37mm
	4# 深度80mm	宽度32mm
	5# 深度70mm	宽度30mm

拉钩 retractor	a	b
ZR842RN 口腔	3# 深度90mm	宽度37mm
	4# 深度80mm	宽度32mm
	5# 深度70mm	宽度30mm
	6# 深度70mm	宽度25mm
	7# 深度60mm	宽度22mm

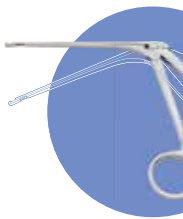

耳鼻喉科
 Ear, Nose and Throat Instruments

Normal quality Series
Ear, Nose and Throat Instruments
耳鼻喉科（普通系列）

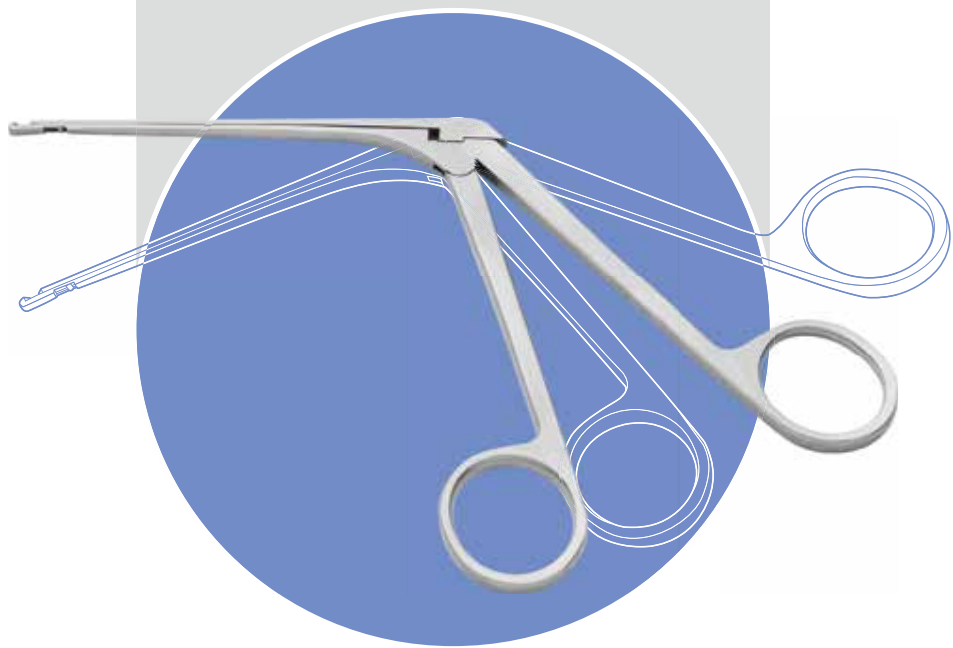

QUALITY
OUR WAY TO SUCCESS

Ear, Nose and Throat Instruments

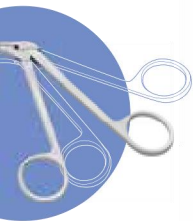

耳鼻喉科
 Ear, Nose and Throat Instruments



听觉检查音叉
 Tuning fork

- ★ Z0297R 128HZ, 有套环
- ★ Z0298R 256HZ, 有套环



听觉检查音叉
 Tuning fork

- ★ Z0299R 512HZ, 无套环
- ★ Z0300R 1024HZ, 无套环
- ★ Z0301R 2048HZ, 无套环



耳鼓膜刀 (鼓膜刀)
 Myringa knife, angled curved

- ★ Z0108RN 170角弯三角刃



耳镜
 Otoscope

- Z03980R 光纤 Optical Fiber (不带气囊) (without bulb)
- Z03981R 鼓气 with bulb (带有气囊)



气囊

insufflation bulb



耳鼓膜刀(鼓膜刀)
Myringa knife, angled curved

★Z0109RN
170角弯半月刃



耳鼓膜刀(鼓膜刀)
Myringa knife, bayonet-shaped

Z0110RN
190枪形三角刃

Z0111RN
190枪形半月刃



耳刮匙(乳突刮匙)
Mastoid curette

- ★Z0155R 160×1.5
- ★Z0156R 160×2
- ★Z0157R 160×2.5
- ★Z0158R 160×3
- ★Z0159R 160×3.5
- Z0160R 160×4
- Z0241R 160×4.5
- Z0161R 160×5
- Z0162R 160×5.5
- Z0163R 160×6



耳刮匙
Ear curette

Z0320R
160×1.0, 直, 单头, 圆头

Z0321R
160×1.5, 直, 单头, 圆头

★Z0184R
160×1.8 圆头

★Z0185R
160×2 圆头
Straight, round tip

★Z0152R
160×2 单头椭圆
Straight, oval tip

Z0322R
160×1.2, 微弯, 单头, 椭圆头

Z0323R
160×1.5, 微弯, 单头, 椭圆头
Slightly curved, oval tip

Z0324R
160×1.2, 弯, 单头, 椭圆头

Z0325R
160×1.5, 弯, 单头, 椭圆头
Curved, oval tip

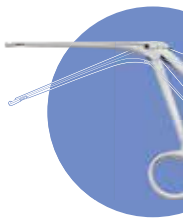

耳鼻喉科
Ear, Nose and Throat Instruments

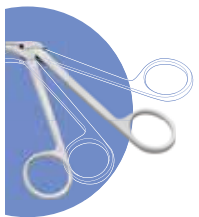

耳鼻喉科
 Ear, Nose and Throat Instruments

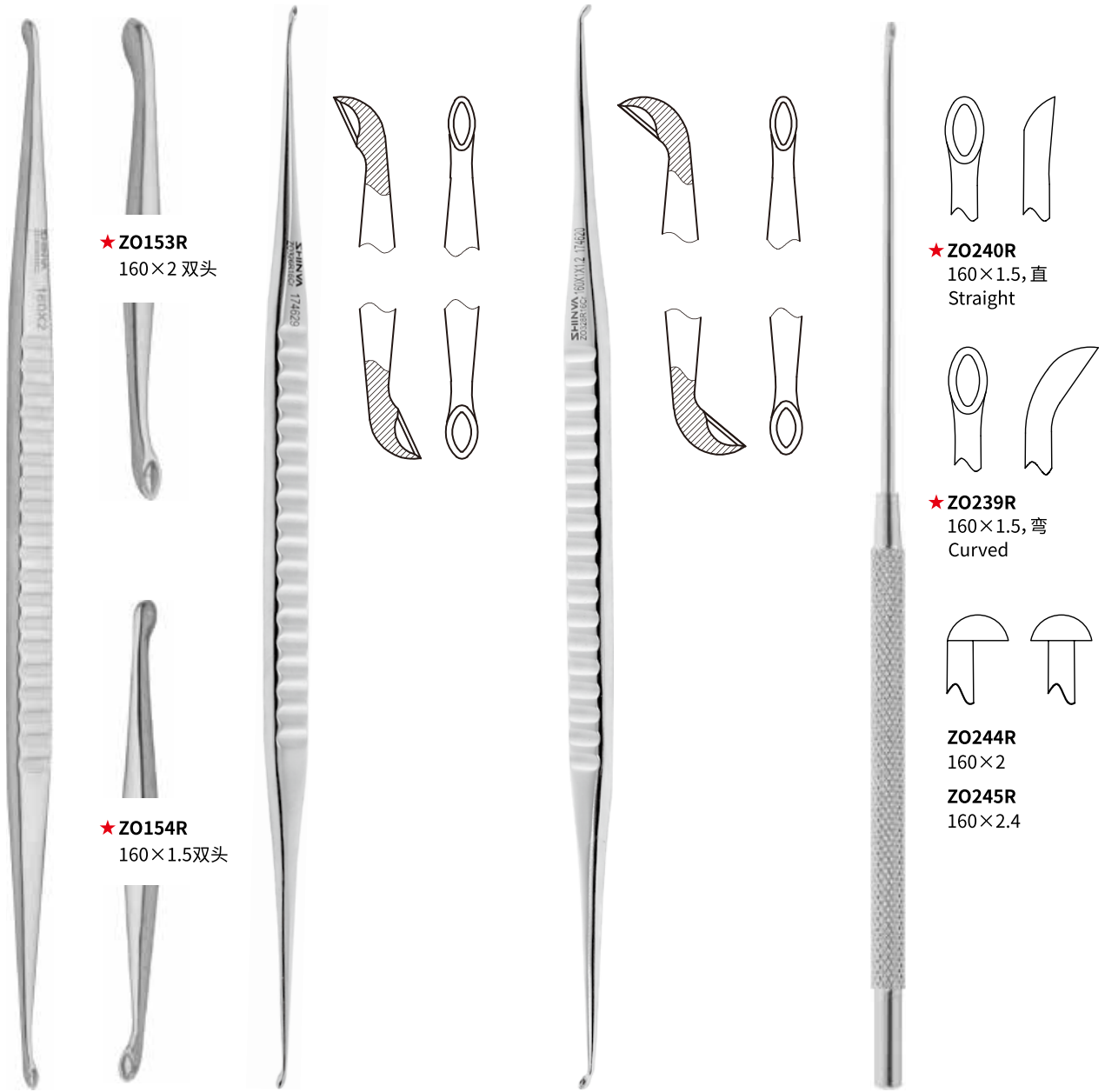

★ **ZO153R**
 160×2 双头

★ **ZO154R**
 160×1.5双头

★ **ZO240R**
 160×1.5, 直
 Straight

★ **ZO239R**
 160×1.5, 弯
 Curved

ZO244R
 160×2

ZO245R
 160×2.4

耳刮匙
 Ear curette, double ended

耳刮匙
 Ear curette slightly curved, oval tip

耳刮匙
 Ear curette curved, oval tip

耳刮匙
 Ear curette

ZO326R
 160×1.0×1.2, 微弯, 双头, 椭圆头
ZO327R
 160×1.5×1.8, 微弯, 双头, 椭圆头

ZO328R
 160×1.0×1.2, 弯, 双头, 椭圆头
ZO329R
 160×1.5×1.8, 弯, 双头, 椭圆头



耳刮匙 (耳用环状刮匙)
Ear loop

★ **ZO226R**
150×1 直

内径 Inner dia. φ1
外径 Outer dia. φ2

★ **ZO228R**
150×2 直

φ2 φ3

★ **ZO230R**
150×3 直

φ3 φ4



★ **ZO227R**
150×1 弯

内径 Inner dia. φ1
外径 Outer dia. φ2

吸引管 (乳突吸引管)
Mastoid suction tube

★ **ZO135R** 190×φ3
★ **ZO136R** 190×φ4
★ **ZO137R** 190×φ5

总长 Total L
工作长度 Working L

190 87
190 87
190 87

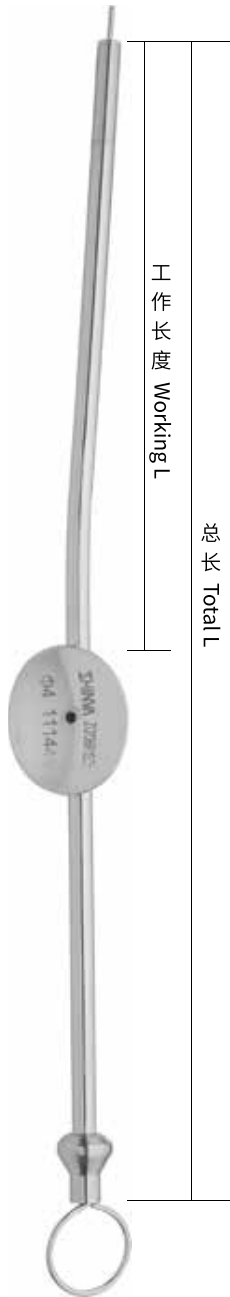

工作长度 Working L

总长 Total L



吸引管 (耳用)
Ear suction tube

★ **ZO262RN** 50×φ1.5, 直
总长 Total L 125
工作长度 Working L 50

★ **ZO263RN** 50×φ2, 直
总长 Total L 125
工作长度 Working L 50



吸引管 (耳用)
Ear suction tube

★ **ZO266RN** 90×φ1.5, 上弯
总长 Total L 165
工作长度 Working L 90

★ **ZO267RN** 90×φ2, 上弯
总长 Total L 165
工作长度 Working L 90



耳鼻喉科
Ear, Nose and Throat Instruments

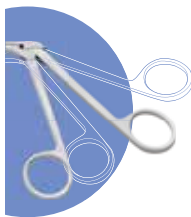

耳鼻喉科
 Ear, Nose and Throat Instruments

吸引管(耳用)
 Ear suction tube

	总长 Total L	工作长度 Working L
★Z0264RN 90×Φ1.5, 直	165	90
★Z0265RN 90×Φ2, 直	165	90

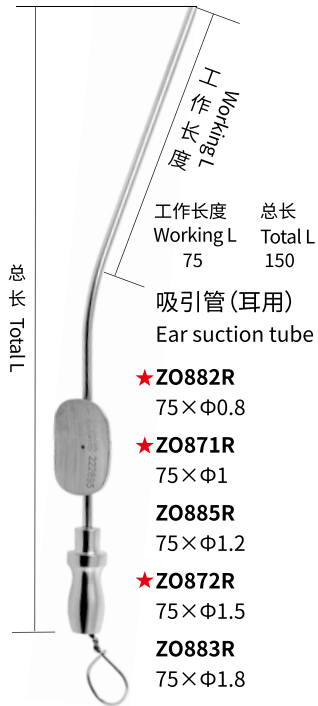

- ★Z0882R
75×Φ0.8
- ★Z0871R
75×Φ1
- Z0885R
75×Φ1.2
- ★Z0872R
75×Φ1.5
- Z0883R
75×Φ1.8
- Z0873R
75×Φ2
- Z0884R
75×Φ2.5

吸引管(耳用)
 Ear suction tube

	总长 Total L	工作长度 Working L
★Z0268RN 90×Φ1.5, 下弯	165	90
★Z0269RN 90×Φ2, 下弯	165	90

显微剥离器(耳剥离子)
 Ear raspatory

- ★Z0183R 160×1
- ★Z0164R 160×1.5
- ★Z0165R 160×2

耳道皮瓣刀(耳横切口刀)
 Ear Knife



★Z0187R
 160×2.4 锐 Sharp

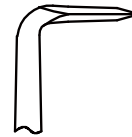

Z0134R
 160x2.5x90°, 角弯, 锐
 Sharp

显微剥离器(耳开窗匙)
 Ear Raspatory

- ★Z0188R 160×0.9 右弯
 Right curved
- ★Z0189R 160×0.9 左弯
 Left curved



- ★ **ZO220R**
150×2, 平头
- ★ **ZO221R**
150×3, 平头
- ★ **ZO222R**
150×4, 平头

- ★ **ZO223R**
150×2, 圆头
- ★ **ZO224R**
150×3, 圆头
- ★ **ZO225R**
150×4, 圆头

乳突骨凿
 Mastoid chisel



- ★ **ZO190R**
160×1.7, 直, 圆刃 Straight
- ★ **ZO138R**
160×2, 直, 圆刃 Straight

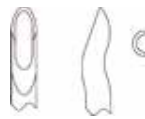

- ZO191R**
160×2 弯 Curved

耳用骨凿(耳圆凿)
 Ear gouge



耳用骨凿(耳圆凿)
 Ear gouge

- ZO139R**
130×3, 直, 圆刃 Straight



耳用骨凿(耳平凿)
 Ear chisel

- ★ **ZO192R** 160×0.6
- ZO252R** 160×1.4, 直



耳鼻喉科
 Ear, Nose and Throat Instruments

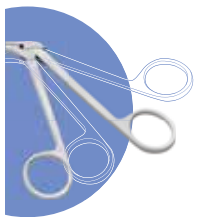

耳鼻喉科
 Ear, Nose and Throat Instruments



显微耳针 (蹬骨底板钻)
 Ear needle

- ★Z0193R 160×1
- ★Z0128R 160×0.5



耳道皮瓣刀 (耳切口刀)
 Ear knife

- ★Z0195R 160×2.2 直
 Straight



★Z0196R
 160×1.2 直 Straight

★Z0197R
 160×1.2 弯 Curved



Z0248R
 160, 半月形
 Half moon
 shaped

显微刀
 Ear knife

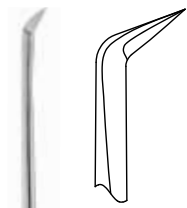

★ **Z0251R**
160×120°, 镰刀形



★ **Z0249R**
160×150°, 镰刀形



显微刀
Ear knife, sickled-shape

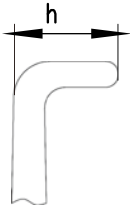

★ **Z0246R**
160×2.5×90°, 锐 Sharp

★ **Z0205R**
160×2×90°, 钝 Blunt

★ **Z0206R**
160×2×90°, 锐 Sharp

★ **Z0125R**
160×0.3×90°, 锐 Sharp

★ **Z0126R**
160×0.6×90°, 锐 Sharp

★ **Z0127R**
160×1×90°, 锐 Sharp



★ **Z0207R**
160×1.5×120°, 锐 Sharp

★ **Z0247R**
160×2×120°, 锐 Sharp

★ **Z0208R**
160×1.5×95°, 锐 Sharp

★ **Z0209R**
160×2.5×95°, 锐 Sharp



耳钩
Ear hook

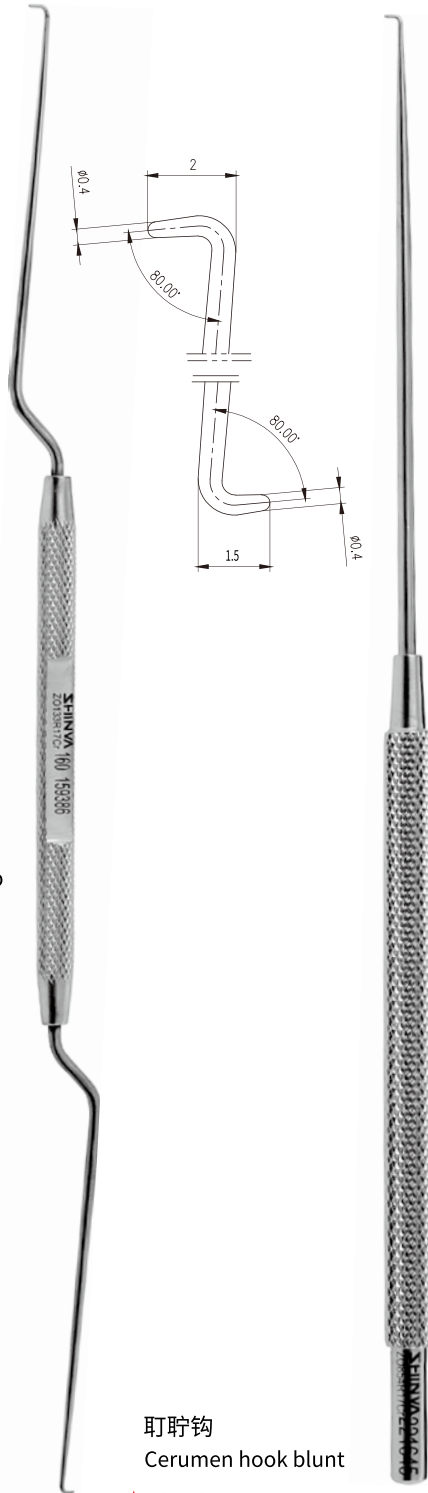

耵聍钩
Cerumen hook blunt

★ **Z0853R**
h
160×1.5, 单头, 角弯90°, 直形, 钝头

★ **Z0854R**
h
160×2.0, 单头, 角弯90°, 直形, 钝头

★ **Z0855R**
h
160×2.5, 单头, 角弯90°, 直形, 钝头

耵聍钩
Cerumen hook

★ **Z0133R**
160, 0.4×1.5/0.4×2
双头, 枪形, 钝头
Double ended, blunt

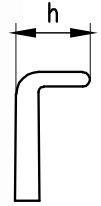

耳鼻喉科
Ear, Nose and Throat Instruments

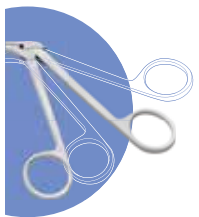

耳鼻喉科
 Ear, Nose and Throat Instruments



盯聆钩
 Cerumen hook blunt

- ★ **Z0856R**
 h
 200×1.5, 单头, 角弯90°, 枪形, 钝头
- ★ **Z0857R**
 h
 200×2.0, 单头, 角弯90°, 枪形, 钝头
- Z0858R**
 h
 200×2.5, 单头, 角弯90°, 枪形, 钝头



耳钩
 Ear hook, sharp

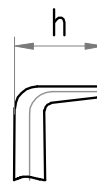
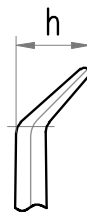

- Z0841R** 160×0.3×25°, 锐钩
- Z0842R** 160×0.6×25°, 锐钩
- Z0843R** 160×1×25°, 锐钩

- Z0844R** 160×0.3×45°, 锐钩
- Z0845R** 160×0.6×45°, 锐钩
- Z0846R** 160×1×45°, 锐钩

- Z0847R** 160×1.2×45°, 锐钩
- Z0848R** 160×1.5×45°, 锐钩
- Z0849R** 160×2×45°, 锐钩

- Z0850R** 160×1.2×90°, 锐钩
- Z0851R** 160×1.5×90°, 锐钩
- Z0852R** 160×2.5×90°, 锐钩

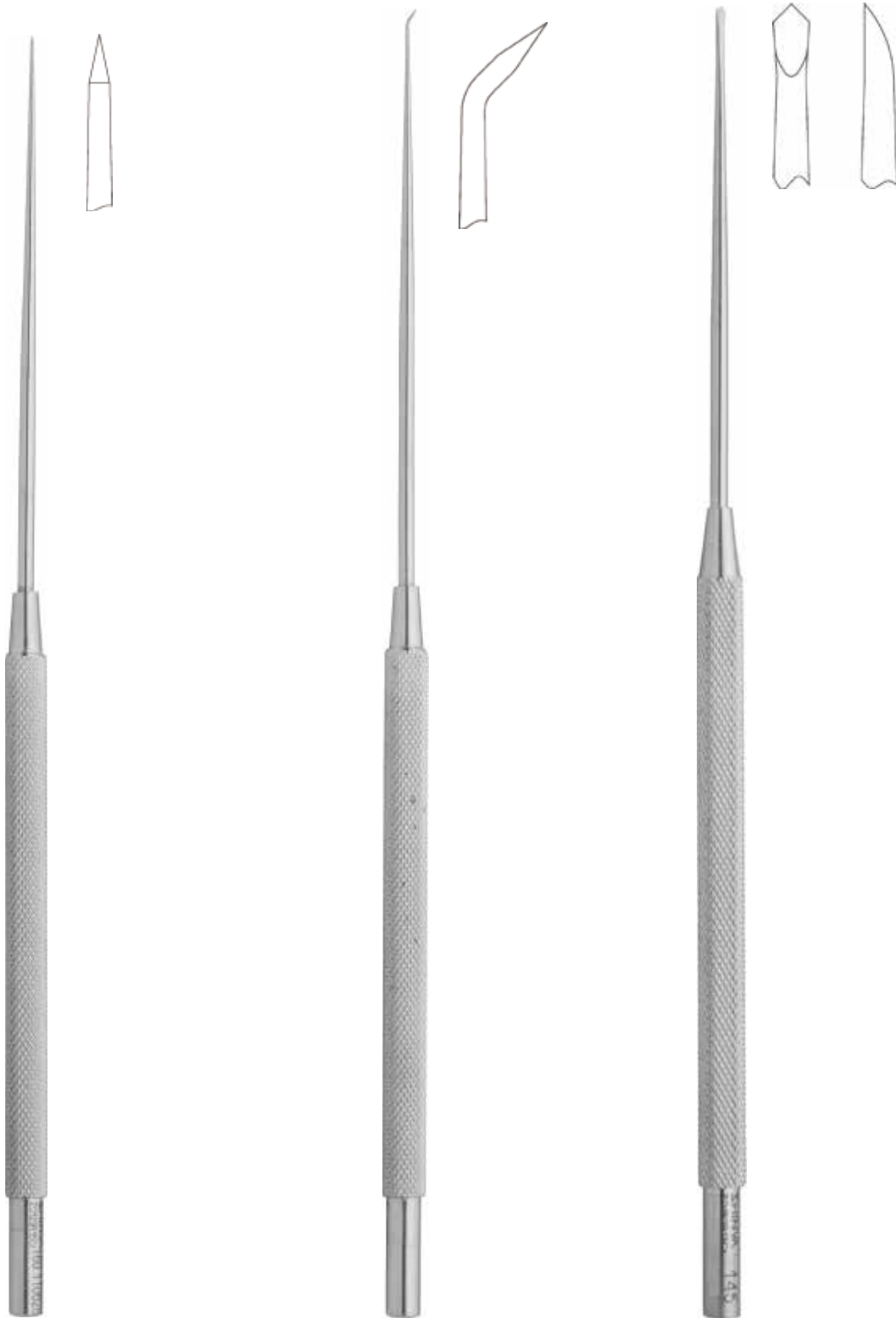

显微耳针 (蹬骨针)
Ear needle
★ZO123R 160 直、锐
Straight, sharp

显微耳针 (耳针)
Ear needle
★ZO124R 160×45°

骨撬 (直撬、耳鼻喉用)
Lever
★ZO150R 145

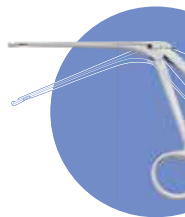

耳鼻喉科
Ear, Nose and Throat Instruments

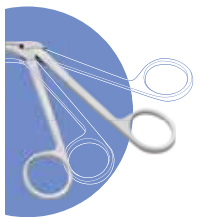

耳鼻喉科
 Ear, Nose and Throat Instruments

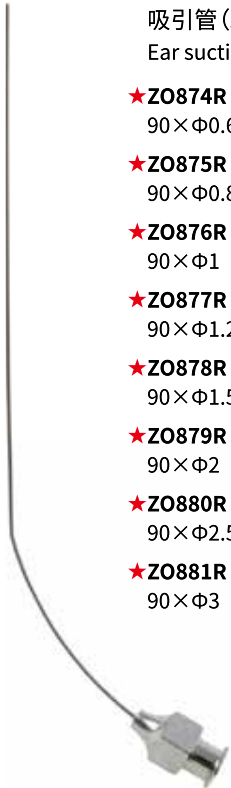

吸引管 (耳用)
 Ear suction tube

- ★ **Z0874R**
90×Φ0.6
- ★ **Z0875R**
90×Φ0.8
- ★ **Z0876R**
90×Φ1
- ★ **Z0877R**
90×Φ1.2
- ★ **Z0878R**
90×Φ1.5
- ★ **Z0879R**
90×Φ2
- ★ **Z0880R**
90×Φ2.5
- ★ **Z0881R**
90×Φ3



吸引头 (微型)
 Micro suction tip

- ★ **Z0149R** 50
 可与上图吸引管配合使用
 For the above suction tubes



Z0210R
 160×2.5 直 Straight

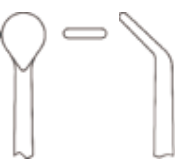

Z0211R
 160×2×45°角弯 Angled
Z0176R
 160×2.5×45°角弯 Angled

耳道皮瓣刀
 Ear knife



耳道皮瓣刀 (小镰状刀)
 Ear knife

- ★ **Z0182R** 160



乳突牵开器(自动)
Self-retaining retractor

- ★ZO132R 130, 3×3钩, 钝钩, 固定式 Blunt
- ZO4005R 130, 3×3钩, 锐钩, 固定式 Sharp



乳突牵开器(自动)
Self-retaining retractor

- ZO4003R 130, 2×2钩, 钝钩, 固定式 Blunt
- ZO4004R 130, 2×2钩, 锐钩, 固定式 Sharp



耳异物钳
Ear Foreign Body Forceps

- ★ZO118R 160×2×6, 麦粒头
- ★ZO119R 160×3×7, 麦粒头

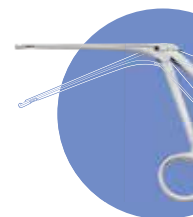

耳鼻喉科
Ear, Nose and Throat Instruments

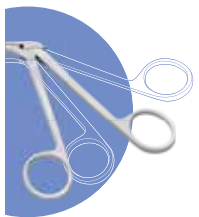

耳鼻喉科
Ear, Nose and Throat Instruments



耳用探针
Ear probe

★Z0113R
180, 枪状



耵聍钩
Cerumen hook

★Z0129R
200×2
★Z0130R
200×4



耳用膝状镊
Troeltsch ear dressing forceps

★Z0114MB
110
★ZD860R
170

组织钳(筋膜钳)
Anadesma forceps

Z0356RN 190





筋膜压薄器(人工鼓环)
Anadesma thinning device

ZO3886RN
螺旋式, 60×40
Screw type



鼻组织剪
Nasal dissecting scissors

- ★ **ZO555RN** 120, 直, 管式 Straight
- ★ **ZO556RN** 120, 左弯, 管式 Left curved
- ★ **ZO557RN** 120, 右弯, 管式 Right curved



鼻组织剪
Nasal dissecting scissors

- ★ **ZO544RN** 130, 盖板式, 直 Straight
- ★ **ZO367RN** 130, 盖板枪式, 左 Left curved
- ★ **ZO368RN** 130, 盖板枪式, 右 Right curved

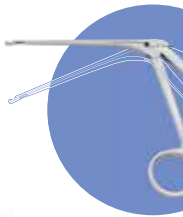

耳鼻喉科
Ear, Nose and Throat Instruments

鼻剪
Nasal dissecting scissors

★Z0112RN 160, 上介



鼻剪
Nasal dissecting scissors

★Z0536RN 110, 枪式, 下介



鼻剪
Nasal dissecting scissors

★Z0541RN 125, 中介

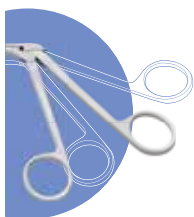

耳鼻喉科
Ear, Nose and Throat Instruments

鼻咬切钳(鼻咬骨钳)
Nasal cutting forceps

★Z0562RN

120×3.5, 盖板式, 下弯, 反切
Downward curved



鼻咬切钳(鼻咬骨钳)
Nasal cutting forceps



★Z0558RN 120×1.5, 盖板式, 正切
Straight



★Z0560RN 120×2, 盖板式, 左反切
Left cutting



★Z0559RN 120×2, 盖板式, 反切



★Z0561RN 120×2, 盖板式, 右反切
Right cutting

★Z0639RN 150×2, 盖板式, 反切



鼻咬切钳
Nasal cutting forceps



★Z0587RN 120×2, 直, 长圆头 Straight

★Z0588RN 120×3, 直, 长圆头 Straight

Z03605RN 160×3, 直, 长圆头 Straight



★Z0589RN 120×2×30°, 角弯, 长圆头 Angled

★Z0590RN 120×3×30°, 角弯, 长圆头 Angled

Z03606RN 160×3×30°, 角弯, 长圆头 Angled



耳鼻喉科
Ear, Nose and Throat Instruments



鼻咬切钳
 Nasal cutting forceps



- ★ **ZO3396RN**
120×3, 盖板式, 角弯45°, 长圆头
- ★ **ZO3395RN**
120×2, 盖板式, 角弯45°, 长圆头
- ZO3602RN**
160×2×45°, 盖板式, 角弯45°, 长圆头
- ZO3604RN**
160×3×45°, 盖板式, 角弯45°, 长圆头
- ZO3621RN**
180×2×45°, 盖板式, 角弯45°, 长圆头
- ZO3623RN**
180×3×45°, 盖板式, 角弯45°, 长圆头

- ZO3392RN**
120×1, 盖板式, 直, 长圆头
- ★ **ZO3393RN**
120×2, 盖板式, 直, 长圆头
- ★ **ZO3394RN**
120×3, 盖板式, 直, 长圆头
- ZO3601RN**
160×2, 盖板式, 直型, 长圆头
- ZO3603RN**
160×3, 盖板式, 直型, 长圆头
- ZO3620RN**
180×2, 盖板式, 直型, 长圆头
- ZO3622RN**
180×3, 盖板式, 直型, 长圆头



- ★ **ZO334RN**
150×2, 盖板式, 尖头, 直
- ★ **ZO335RN**
150×2.5, 盖板式, 尖头, 直

- ★ **ZO336RN**
150×2, 盖板式, 尖头, 上翘45°
- ★ **ZO337RN**
150×2.5, 盖板式, 尖头, 上翘45°

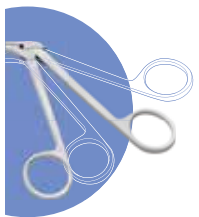

耳鼻喉科
 Ear, Nose and Throat Instruments



鼻咬切钳
Nasal cutting forceps

- ★ **ZO343RN** 100×2反切带,吸引长圆头
- ★ **ZO391RN** 100×3反切带,吸引长圆头



鼻咬切钳
Nasal cutting forceps rotatable

- ★ **ZO389RN** 110×1.5管式反切可旋转长圆头
- ★ **ZO390RN** 110×2.5管式反切可旋转长圆头

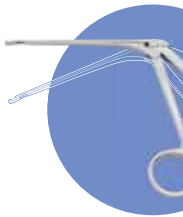

耳鼻喉科
Ear, Nose and Throat Instruments

上颌窦咬骨钳
 Nasal cutting forceps

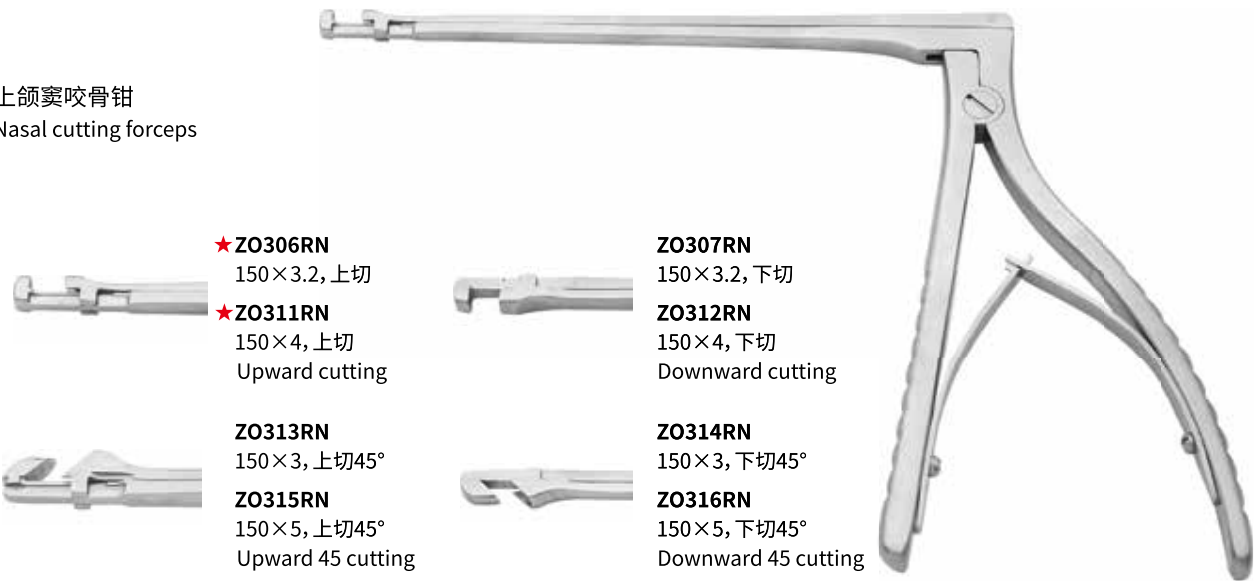

★**ZO306RN**
 150×3.2, 上切

★**ZO311RN**
 150×4, 上切
 Upward cutting

ZO313RN
 150×3, 上切45°

ZO315RN
 150×5, 上切45°
 Upward 45 cutting

ZO307RN
 150×3.2, 下切

ZO312RN
 150×4, 下切
 Downward cutting

ZO314RN
 150×3, 下切45°

ZO316RN
 150×5, 下切45°
 Downward 45 cutting

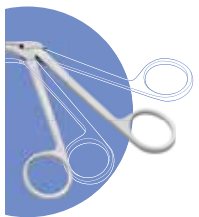

耳鼻喉科
 Ear, Nose and Throat Instruments

蝶窦咬骨钳(鼻窦咬骨钳)
 Nasal cutting forceps

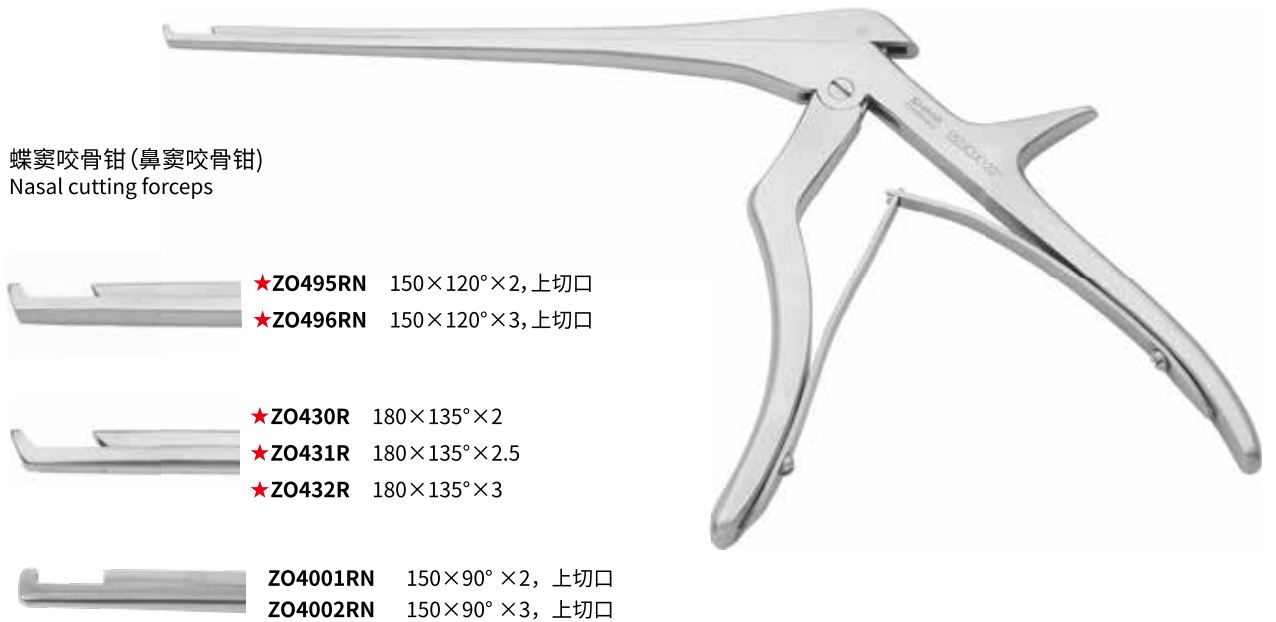

★**ZO495RN** 150×120°×2, 上切口

★**ZO496RN** 150×120°×3, 上切口

★**ZO430R** 180×135°×2

★**ZO431R** 180×135°×2.5

★**ZO432R** 180×135°×3

ZO4001RN 150×90°×2, 上切口

ZO4002RN 150×90°×3, 上切口

蝶窦咬骨钳(鼻窦咬骨钳)
Nasal cutting forceps

- ★ **ZO497RN**
140×2.5×90°,可旋转
Rotatable



鼻中隔咬骨钳
Septum cutting forceps

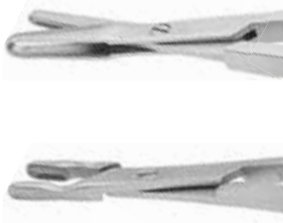

- ★ **ZO423RN** 180×2, 对切口
- ★ **ZO425RN** 180×3, 对切口
- ★ **ZO426RN** 180×4, 对切口
- ★ **ZO424RN** 180×3, 对咬口
- ★ **ZO427RN** 180×4, 对咬口

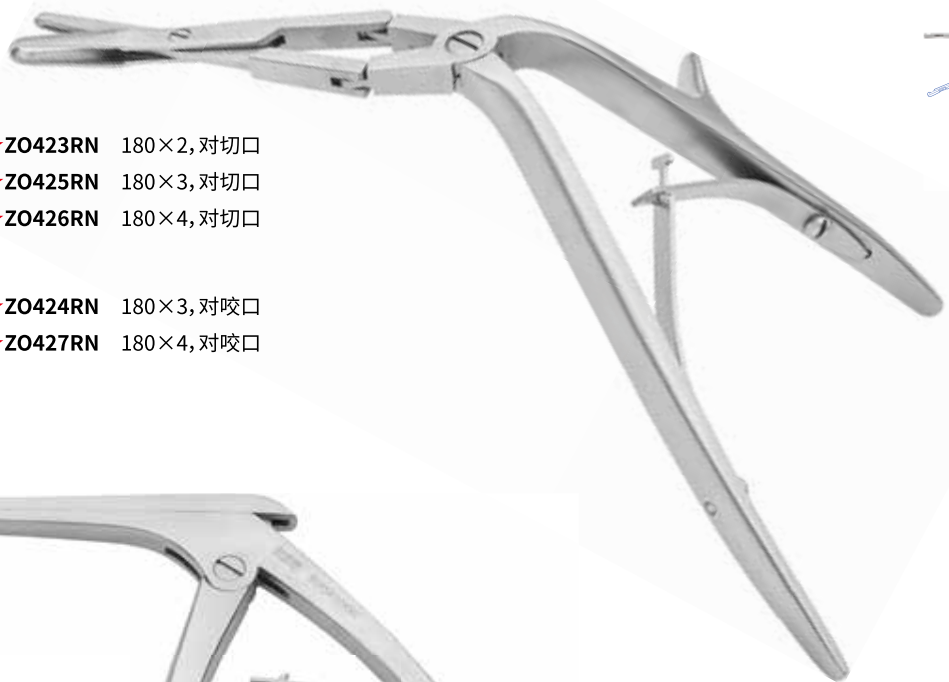

乳突咬骨钳
Mastoid cutting forceps

- ZO340RN** 90×2
- ★ **ZF647RN** 90×3
- ★ **ZF648RN** 90×4
- ZF649RN** 90×5



耳鼻喉科
Ear, Nose and Throat Instruments

鼻组织钳
 Nasal tissue forceps

- 

★**ZO3568RN**
 130×4.5, 直, 管式, 尖圆头
 Straight
- 

★**ZO3569RN**
 130×4×55°, 左弯, 管式, 尖圆头

ZO3570RN
 130×4.5×55°, 左弯, 管式, 尖圆头
 Left curved
- 

ZO3571RN
 130×4×55°, 右弯, 管式, 尖圆头

ZO3572RN
 130×4.5×55°, 右弯, 管式, 尖圆头
 Right curved

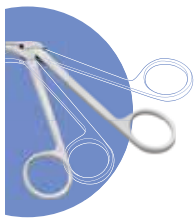

耳鼻喉科
 Ear, Nose and Throat Instruments

鼻组织钳
 Nasal tissue forceps

- ZO506RN** 120×5, 盖板式, 直圆头
- ZO507RN** 120×6, 盖板式, 直圆头
- ZO508RN** 120×7, 盖板式, 直圆头



鼻组织钳
 Nasal tissue forceps

- ★**ZO563RN**
 120×4, 盖板式, 直带齿长圆头





鼻组织钳
 Nasal tissue forceps

★ **ZO573RN** 120×5×110°, 横开, 管式, 蝴蝶头



鼻组织钳(鼻息肉钳)
 Nasal polypus forceps

 ★ **ZO638RN** 150×3, 直尖圆, 带孔

 ★ **ZO3500RN** 120×3, 直尖圆, 带孔

★ **ZO3501RN** 120×4, 直尖圆, 带孔
 ★ **ZO3630RN** 160×3, 直尖圆, 带孔

 ★ **ZO3498RN** 120×3, 直长圆头
 ★ **ZO3633RN** 160×3, 直长圆

 ★ **ZO3502RN** 120×3, 角弯45°, 尖圆头, 带孔

★ **ZO3503RN** 120×4, 角弯45°, 尖圆头, 带孔
 ★ **ZO3632RN** 160×3, 角弯45°, 尖圆头, 带孔

 ★ **ZO3509RN**
 120×5, 盖板式, 直椭圆头

 ★ **ZO3504RN** 120×3, 角弯90°, 尖圆头, 带孔

★ **ZO3505RN** 120×4, 角弯90°, 尖圆头, 带孔
 ★ **ZO615RN** 110×4×90°, 尖圆头, 带孔

 ★ **ZO3499RN**
 120×3, 角弯45°, 长圆头
 ★ **ZO3634RN**
 160×3, 角弯30°, 长圆头
 ★ **ZO3635RN**
 160×3, 角弯45°, 长圆头

 ★ **ZO3576RN** 120×3, 角弯30°, 尖圆头, 带孔

★ **ZO3631RN** 160×3, 角弯30°, 尖圆头, 带孔

 ★ **ZO574RN** 120×4, 直长圆头

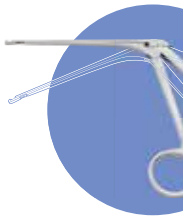

耳鼻喉科
 Ear, Nose and Throat Instruments



鼻组织钳(鼻息肉钳)

Nasal polypus forceps with suction

- ★ **ZO564R** 120×4, 盖板式带吸引, 直尖圆头 Straight
- ZO565R** 120×4×30°, 盖板式带吸引, 角弯尖圆头 Angled
- ZO566R** 120×4×45°, 盖板式带吸引, 角弯尖圆头 Angled
- ZO567R** 120×4×90°, 盖板式带吸引, 角弯尖圆头 Angled

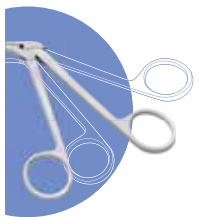

耳鼻喉科
 Ear, Nose and Throat Instruments

鼻咽活体取样钳(鼻取样钳)
 Nasal biopsy forceps



- ★ **ZO514RN**
 140, 直, 管式, 长圆头, 竖开
 Straight, vertical opening
- ★ **ZO515RN**
 140, 直, 管式, 长圆头, 横开
 Straight, horizontal opening



- ★ **ZO516RN**
 140×70°, 管式
 角弯, 长圆头, 竖开
 Angled, vertical opening



- ★ **ZO517RN**
 140×70°, 管式
 角弯, 长圆头, 横开
 Angled, horizontal opening



- ★ **ZO518RN**
 140×110°, 管式
 角弯, 长圆头, 竖开
 Angled, vertical opening



- ★ **ZO519RN**
 140×100°, 管式
 角弯, 长圆头, 横开
 Angled, horizontal opening



鼻咽活体取样钳(鼻取样钳)
Nasal biopsy forceps straight

- ★Z0510RN 160×3, 盖板式, 直形
- ★Z0512RN 160×4, 盖板式, 直形



鼻咽活体取样钳(鼻取样钳)
Nasal biopsy forceps angled

- ★Z0511RN 140×3, 盖板式, 角弯
- Z0513RN 140×4, 盖板式, 角弯



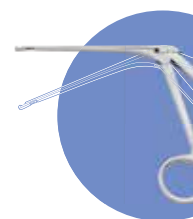

鼻咽活体取样钳(鼻取样钳)
Nasal biopsy forceps angled

- ★Z0579RN 140×3, 盖板式, 角弯, 长圆头







耳鼻喉科
Ear, Nose and Throat Instruments

鼻咽活体取样钳(鼻取样钳)
 Nasal biopsy forceps

-  **★Z0580RN** 150×Φ3, 管式, 上开口
Upward cutting
-  **Z0581RN** 150×Φ3, 管式, 左开口
Left cutting
-  **Z0582RN** 150×Φ3, 管式, 右开口
Right cutting





鼻咽活体取样钳(鼻取样钳)
 Nasal biopsy forceps with suction

-  **Z0584RN** 170×3×30°, 角弯, 管式带吸引
-  **Z0585RN** 170×3×45°, 角弯, 管式带吸引
Angled
-  **Z0583RN** 170×3, 直, 管式带吸引
Straight
-  **Z0586RN** 170×3×90°, 角弯, 管式带吸引
Angled



鼻异物钳
 Nasal foreign body forceps

-  **★Z0453RN** 110, 有钩, 盖板式
With mouseteeth
-  **★Z0454RN** 110, 无钩, 盖板式

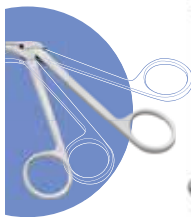
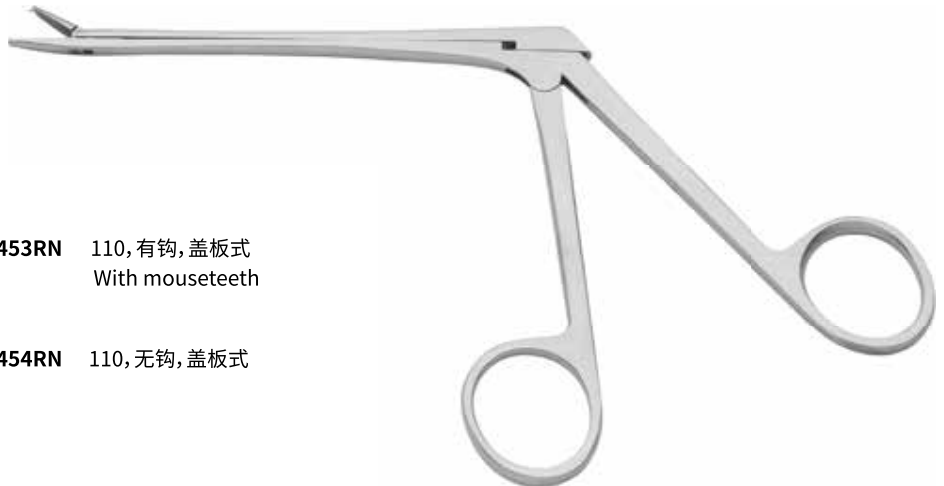

耳鼻喉科
 Ear, Nose and Throat Instruments

鼻筛窦钳(鼻筛窦开放钳)
Antrum forceps



★ZO1024RN 130×4, 直, 长圆头



★ZO1026RN 130×4.5, 直, 尖圆头



★ZO1027RN 130×5.5, 直, 尖圆头

★ZO1025RN 130×4×45°, 角弯, 长圆头



鼻粘膜钳
Nasal forceps

★ZO1036RN 120×5

ZO1037RN 120×6



上颌窦止血钳
Hemostatic forceps

ZO308RN 125×3.5

ZO309RN 125×4

ZO310RN 125×4.5

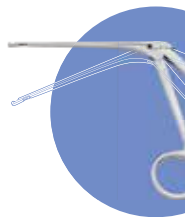

耳鼻喉科
Ear, Nose and Throat Instruments



鼻息肉钳 (吸引息肉钳)

Polypus forceps, detachable straight

- ★ZO1043RN 140×Φ3, 直, 可拆卸
- ★ZO1044RN 140×Φ4, 直, 可拆卸
- ★ZO1045RN 140×Φ5, 直, 可拆卸



鼻咬切钳 (蝶窦口扩大钳)

Nasal dilating forceps

- ★ZO1048RN 180×Φ3.5, 直 Straight
- ★ZO1049RN 180×Φ4.5, 直 Straight
- ★ZO1050RN 180×Φ3.5×30° Curved
- ★ZO1051RN 180×Φ4.5×30° Curved



鼻组织钳 (鼻窦抓钳)

Antrum grasping forceps

- ★ZO1065RN 135×5, 下弯90°, 后开120°
Downward curved 90, backward 120
- ★ZO1067RN 140×5, 长弯下弯115°
Downward 115

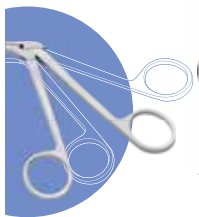

耳鼻喉科
 Ear, Nose and Throat Instruments

鼻组织钳(鼻窦抓钳)
 Antrum grasping forceps



★ **ZO1066RN** 140×5,长弯上弯115°
 Upward 115

★ **ZO1064RN** 135×5,上弯90°,后开120°
 Upward curved 90,backward 120

鼻息肉钳
 Nasal polypus forceps



ZO1100RN 120×2×6,麦粒头,叠鳃式

ZO575RN 120×2.5×6,麦粒头,叠鳃式

ZO1101RN 120×3×6,麦粒头,叠鳃式

ZO1102RN 120×3.5×4.5,环形,叠鳃式

ZO429RN 120×3.5×5,环形,叠鳃式

ZO1103RN 120×3.5×5.5,环形,叠鳃式

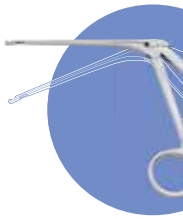

耳鼻喉科
 Ear, Nose and Throat Instruments



鼻息肉钳
Nasal polypus forceps

ZO1110RN 110×2×4, 麦粒头, 叠颚式

ZO1111RN 110×2.5×4, 麦粒头, 叠颚式

ZO1112RN 110×3×4, 麦粒头, 叠颚式

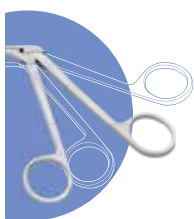

耳鼻喉科
Ear, Nose and Throat Instruments



鼻腔填塞钳
Nasal dressing forceps

★**ZO481RN** 180



鼻腔撑开器 (鼻中隔镜)
Nasal septum speculum

★ZO383R
55×80, 鼻腔撑开器 (鼻中隔镜)



鼻刮匙 (鼻窦刮匙)
Antrum curette

ZO1004RN
190×4, 直, 碗形有孔

ZO1009RN
190×4.5, 直, 碗形有孔

ZO1014RN
190×5, 直, 碗形有孔

ZO1005RN
190×4×15°, 弯, 碗形有孔

ZO1010RN
190×4.5×15°, 弯, 碗形有孔

ZO1015RN
190×5×15°, 弯, 碗形有孔

ZO1006RN
190×4×30°, 弯, 碗形有孔

ZO1011RN
190×4.5×30°, 弯, 碗形有孔

ZO1016RN
190×5×30°, 弯, 碗形有孔

ZO1007RN
190×4×45°, 弯, 碗形有孔

ZO1012RN
190×4.5×45°, 弯, 碗形有孔

ZO1017RN
190×5×45°, 弯, 碗形有孔

ZO1008RN
190×4×90°, 弯, 碗形有孔

ZO1013RN
190×4.5×90°, 弯, 碗形有孔

ZO1018RN
190×5×90°, 弯, 碗形有孔



鼻刮匙
Nasal curette

★ZO520RN
190×90°×2.5
单头, 角弯, 匙形

★ZO521RN
190×45°×2.5
单头, 角弯, 匙形

★ZO522RN
190×3.5
单头, 角弯, 匙形

ZO523RN
190×4.5
单头, 角弯, 匙形

ZO524RN
190×Φ4.5
单头, 弯, 碗形



耳鼻喉科
Ear, Nose and Throat Instruments

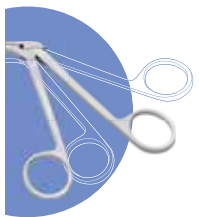

耳鼻喉科
 Ear, Nose and Throat Instruments



鼻刮匙
 Nasal curette

★ZO525RN
 190×5.5, 单头
 直, 匙形



鼻刮匙
 Nasal curette

★ZO526RN
 210, Φ6/Φ8
 双头, 弯环形



鼻刮匙
 Nasal curette

★ZO527RN
 190×Φ3
 单头, 弯环形



鼻刮匙
 Nasal curette

- ZO616R 170×5, 直型, 有孔, 圆刃
- ZO617R 170×5.6, 直型, 有孔, 圆刃
- ZO618R 170×7, 直型, 有孔, 圆刃
- ZO619R 170×5×15°, 有孔, 圆刃
- ZO483R 170×5.6×15°, 圆刃, 有孔
- ZO416R 170×7×15°, 圆刃, 有孔
- ZO620R 170×5×30°, 有孔, 圆刃
- ZO540R 170×5.6×30°, 圆刃, 有孔
- ZO538R 170×7×30°, 圆刃, 有孔
- ZO621R 170×5×45°, 有孔, 圆刃
- ZO622R 170×5.6×45°, 有孔, 圆刃
- ZO623R 170×7×45°, 有孔, 圆刃



★ZO543R 170×7×110°, 圆刃



ZO539R 170×5.6×30°, 三角刃

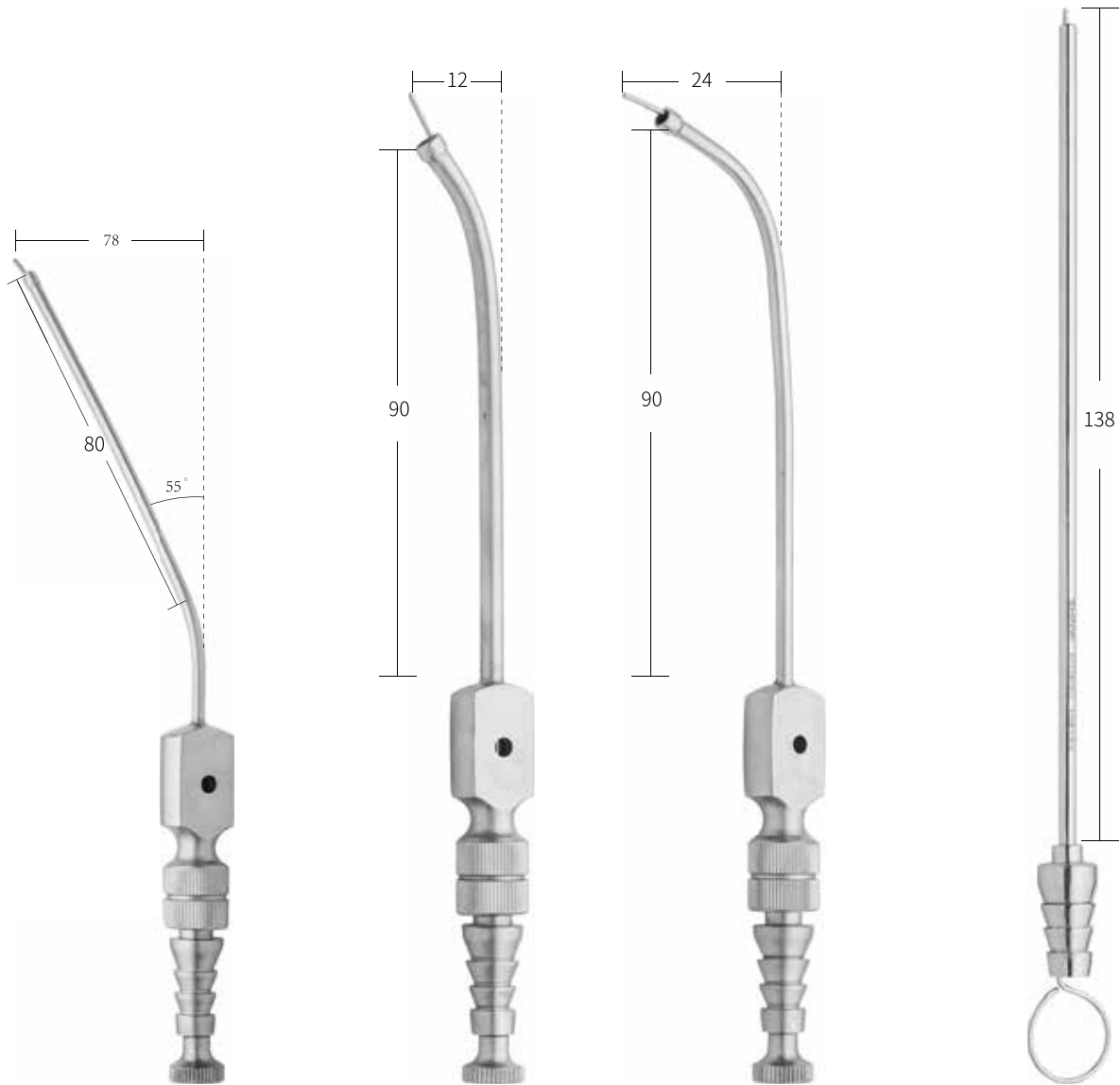

鼻腔吸引管
Nasal suction tube

- ★ **ZO532RN**
130×Φ2.5×55°×78
- ★ **ZO592RN**
130×Φ3×55°×78
- ★ **ZO533RN**
130×Φ4×55°×78

鼻腔吸引管
Nasal suction tube

- ★ **ZO528RN**
150×Φ2.5×12
- ★ **ZO529RN**
150×Φ4×12

鼻腔吸引管
Nasal suction tube

- ★ **ZO530RN**
150×Φ2.5×24, 弯
- ★ **ZO591RN**
150×Φ3×24, 弯
- ★ **ZO531RN**
150×Φ4×24, 弯

鼻腔吸引管
Nasal suction tube

- ★ **ZO730R**
160×Φ2, 直
- ★ **ZO731R**
160×Φ3, 直
- ★ **ZO732R**
160×Φ4, 直

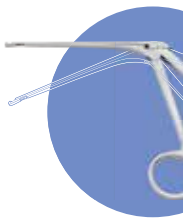

耳鼻喉科
Ear, Nose and Throat Instruments

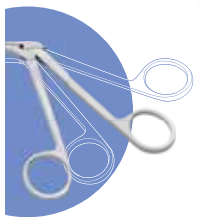

耳鼻喉科
 Ear, Nose and Throat Instruments



鼻腔吸引管
 Nasal suction tube

- ★Z01074RN 220×Φ2.5
- ★Z01075RN 220×Φ3
- ★Z01077RN 220×Φ4



鼻腔吸引管
 Nasal suction tube

- ★Z0733R 160×Φ2, 弯
- ★Z0734R 160×Φ3, 弯
- ★Z0735R 160×Φ4, 弯

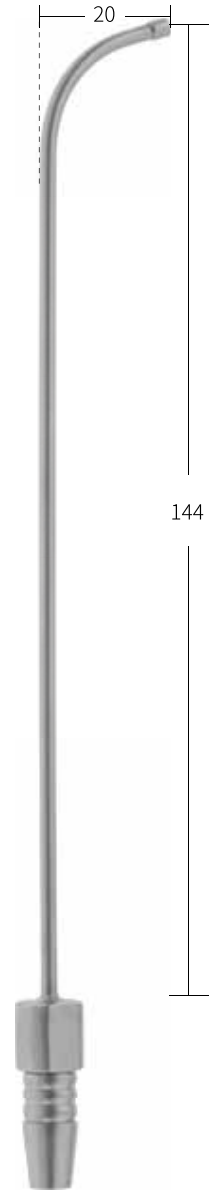

鼻腔吸引管
 Nasal suction tube

- ★Z01084RN 170×Φ2.5
- ★Z01085RN 170×Φ3
- ★Z01086RN 170×Φ3.5
- ★Z01087RN 170×Φ4



鼻腔吸引管
Nasal suction tube

- ★ **ZO1080RN**
180×Φ2.5×47, 弯
- ★ **ZO1081RN**
180×Φ3.5×47, 弯
- ★ **ZO1083RN**
180×Φ3×47, 弯

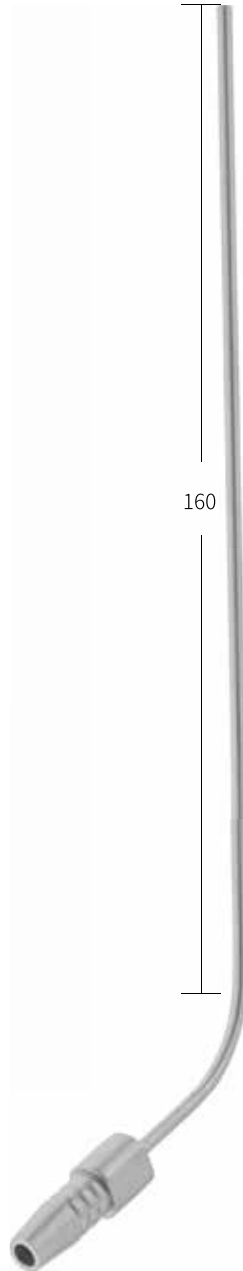

鼻腔吸引管
Nasal suction tube

- ★ **ZO1088RN** 190×Φ2.5
- ★ **ZO1089RN** 190×Φ3
- ★ **ZO1090RN** 190×Φ3.5
- ★ **ZO1091RN** 190×Φ4

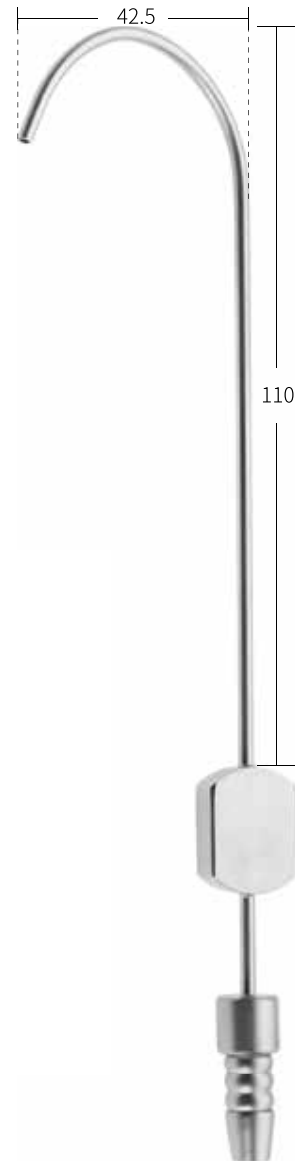

鼻腔吸引管
Nasal suction tube

- ★ **ZO1092RN**
175×Φ2.5, 钩状, 可控
- ★ **ZO1093RN**
175×Φ3, 钩状, 可控
- ★ **ZO1094RN**
175×Φ3.5, 钩状, 可控

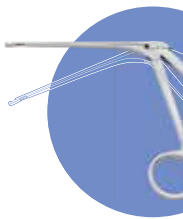

耳鼻喉科
Ear, Nose and Throat Instruments

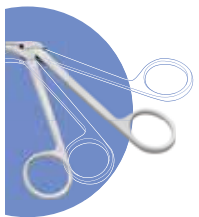

耳鼻喉科
 Ear, Nose and Throat Instruments

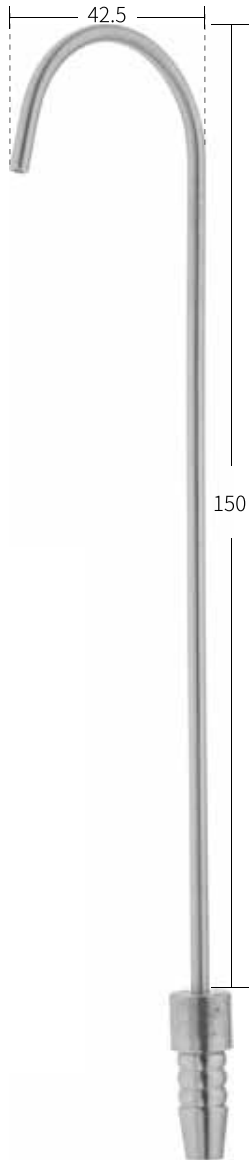

鼻腔吸引管
 Nasal suction tube

- ★ **ZO1095RN**
 175×Φ2.5, 钩状
- ★ **ZO1096RN**
 175×Φ3, 钩状
- ★ **ZO1097RN**
 175×Φ3.5, 钩状



鼻腔吸引管
 Nasal suction tube

- ZO1273RN**
 175×Φ2.5
- ZO1274RN**
 175×Φ3
- ZO1275RN**
 175×Φ3.5



鼻窦冲洗器(上颌窦灌洗管)
 Antrum irrigation cannula

- ★ **ZO413R** Φ2×120
- ★ **ZO442R** Φ2.5×120
- ★ **ZO443R** Φ3×120

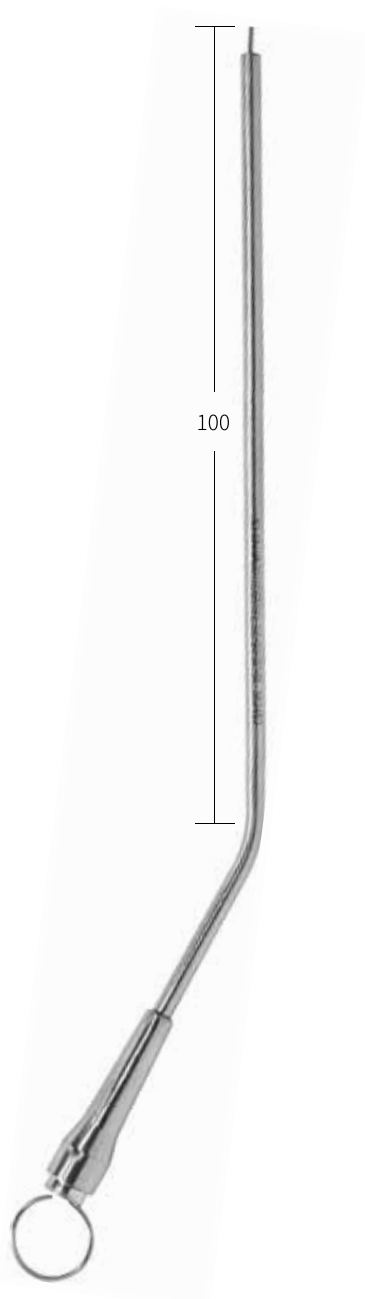

鼻腔吸引管
Nasal suction tube

- ZO1280RB**
155×Φ1.5×30°×55
- ZO1281RB**
155×Φ2×30°×55
- ZO1282RB**
155×Φ2.5×30°×55
- ZO1283RB**
155×Φ3×30°×55
- ZO1284RB**
155×Φ3.5×30°×55

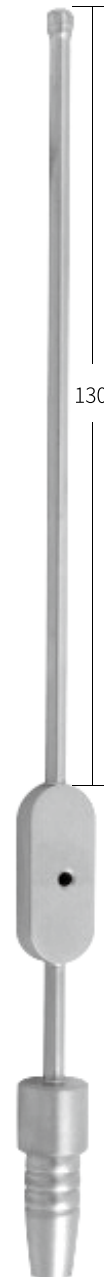

鼻腔吸引管
Nasal suction tube

- ZO1113RN**
190×Φ2.5, 直, 可控, 带保护套
- ZO1114RN**
190×Φ3, 直, 可控, 带保护套
- ZO1115RN**
190×Φ3.5, 直, 可控, 带保护套
- ZO1116RN**
190×Φ4, 直, 可控, 带保护套

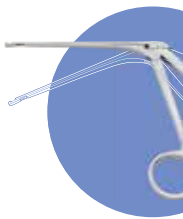

耳鼻喉科
Ear, Nose and Throat Instruments

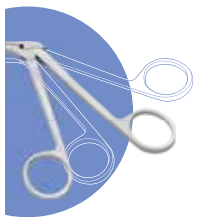

耳鼻喉科
Ear, Nose and Throat Instruments



鼻骨膜剥离器
Nasal periosteum raspatory

- ★ **ZO380RN**
200×4×5, 双头带刻度, 铲形
- ★ **ZO465RN**
200×2×4, 双头带刻度, 铲形



鼻骨膜剥离器
Nasal periosteum raspatory

- ★ **ZO406RN**
180×3, 单头带吸引铲形
- ★ **ZO402RN**
180×5, 单头带吸引铲形



剥离器
Elevator with suction

- ZO628RN**
2.5×45°, 带吸引
- ZO1020RN**
2.5×60°, 带吸引
- ZO1019RN**
2.5×90°, 带吸引



鼻骨膜剥离器
Nasal periosteum raspatory

- ★ **ZO411R** 160×5
- ★ **ZO412R** 160×6
- ★ **ZO414R** 170×4.2, 锐 Sharp



鼻骨膜剥离器
Nasal periosteum raspatory

★Z0410R 140微弯双刃



鼻骨膜剥离器
Nasal periosteum raspatory

★Z0403RN
200×4×5, 双头, 直长圆形
Straight



★Z0121R
190, 头宽4/4, 直
Straight, tip width 3*3



★Z0122R
190, 头宽3/3, 弯
Curved, tip width 3*3



★Z0546RN
180×5×5, 双头, 弯 Curved

★Z0462RN
200×5×5, 双头, 直长圆形
Curved



鼻骨膜剥离器
Nasal periosteum raspatory

★Z0466RN
190×1, 单头, 微弯, 长圆形

★Z0467RN
190×3, 单头, 微弯, 长圆形

★Z0593RN
190×4.5, 单头, 微弯, 长圆形
Slightly curved



★Z0468RN
190×3, 单头, 弯, 长圆形
Curved

★Z0469RN
190×4, 单头, 角弯, 长圆形
Angled



耳鼻喉科
Ear, Nose and Throat Instruments

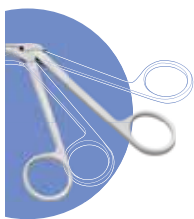

耳鼻喉科
Ear, Nose and Throat Instruments



鼻骨复位钳
Nasal reposition forceps
★ Z01032RN 200弯



鼻骨复位器
Nasal repositioner
★ Z01033R 220×4



鼻穿刺针
Nasal puncture needle



Z0381RN
170×Φ3, 平口
Z0596RN
170×Φ4, 平口



★ Z0597RN
170×Φ3, 斜口
★ Z0598RN
170×Φ4, 斜口



Z0599RN
170×Φ3, 鸟喙口
Z0600RN
170×Φ4, 鸟喙口

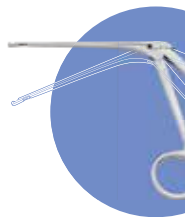
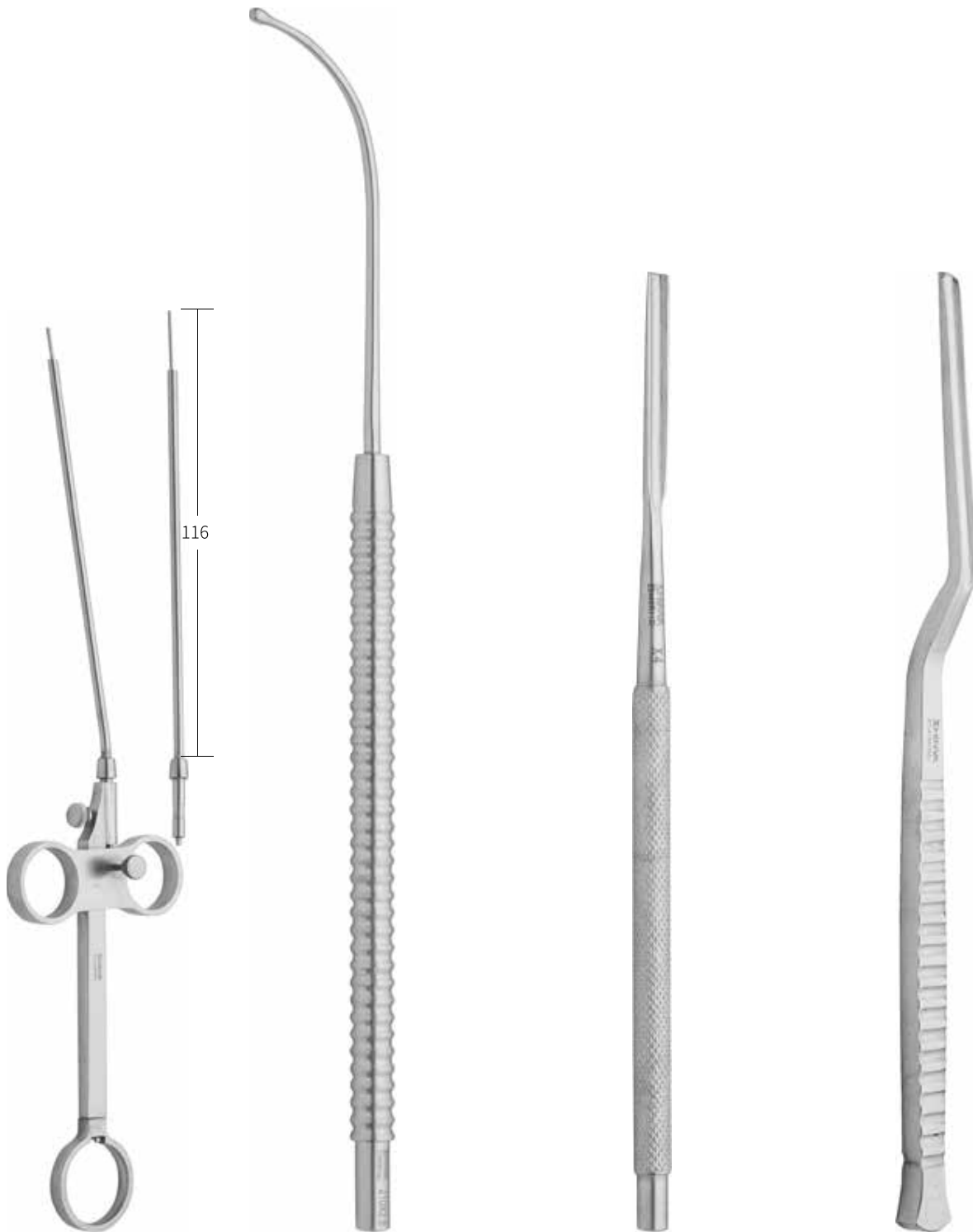

耳鼻喉科
Ear, Nose and Throat Instruments

鼻息肉圈断器
Nasal snare

★Z0534R

探针(鼻用)
Nasal probe

★Z01061R 210×Φ2.5,弯,圆头

鼻中隔凿
Nasal septum gouge

★Z0428R 160×3,直形

★Z0440R 160×4,直形

鼻中隔凿
Nasal septum gouge

★Z0407R 160×3,枪形

★Z0409R 160×4,枪形

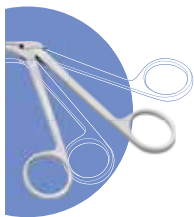

耳鼻喉科
 Ear, Nose and Throat Instruments



鼻中隔凿
 Nasal septum gouge

- ★ZO405R 160×3, 枪形
- ★ZO420R 160×4, 枪形



鼻中隔凿
 Nasal septum gouge

- ★ZO422R 160×4, 直形
- ★ZO404R 160×6, 直形
- ZO421R 160×8, 直形



鼻骨凿
 Ear bone gouge



ZO359RN
 双保护6mm×160

ZO360RN
 双保护8mm×160



ZO361RN
 左保护6mm×160

ZO362RN
 左保护8mm×160
 Left protection



ZO363RN
 右保护6mm×160

ZO364RN
 右保护8mm×160
 Right protection



★ZO594RN
 180, 尖头弯, 方柄
 Sharp



★ZO595RN
 180, 钝头弯, 方柄
 Blunt



鼻粘膜刀(镰状刀)
 Nasal knife



ZO491RN
 190, 枪形单头镰

ZO492RN
 190, 枪形单头圆

鼻粘膜刀
 Nasal knife



鼻粘膜刀
 Nasal knife

★ **ZO477RN** 170×4.5, 直型, 单圆头
 ★ **ZO478RN** 170×4, 直型, 单圆头



鼻粘膜刀
 Nasal knife

★ **ZO482RN** 180×3×5

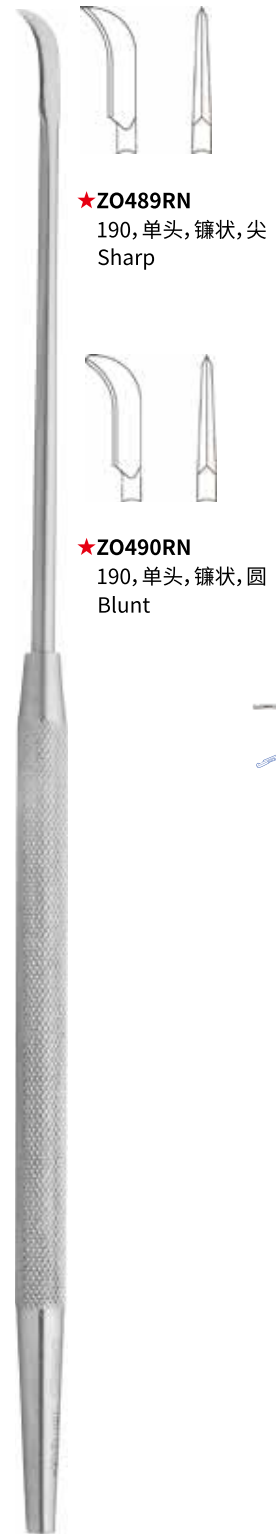

★ **ZO489RN**
 190, 单头, 镰状, 尖
 Sharp

★ **ZO490RN**
 190, 单头, 镰状, 圆
 Blunt

鼻粘膜刀
 Nasal knife

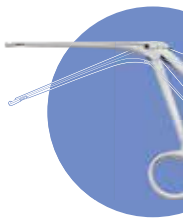

耳鼻喉科
 Ear, Nose and Throat Instruments

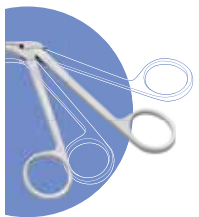

耳鼻喉科
Ear, Nose and Throat Instruments



鼻刮匙(鼻增殖体刮匙)
Adenoid curette

- ★Z0382RN 220×8, 无钩
- ★Z0397RN 220×10, 无钩
- ★Z0398RN 220×12, 无钩
- ★Z0677RN 220×15, 无钩
- ★Z0678RN 220×17, 无钩
- ★Z0679RN 220×19, 无钩



鼻中隔旋转刀
Nasal septum knife

- ★Z0445RN 200枪型刃宽3 Blade W 3
- ★Z0446RN 200枪型刃宽4 Blade W 4
- Z0447RN 200枪型刃宽5 Blade W 5



鼻中隔旋转刀
Nasal septum knife

- ★Z0448RN 200直型刃宽3 Blade W 3
- ★Z0444RN 200直型刃宽4 Blade W 4
- Z0449RN 200直型刃宽5 Blade W 5



鼻窥器
Nasal speculum

ZO3884RB
150×28



鼻窥器(鼻镜)
Nasal speculum

- ★ **ZO080R** 150×20
- ★ **ZO081R** 150×28
- ★ **ZO082R** 155×50
- ★ **ZO083R** 160×75

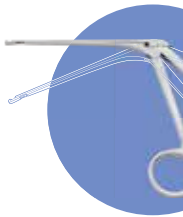

耳鼻喉科
Ear, Nose and Throat Instruments

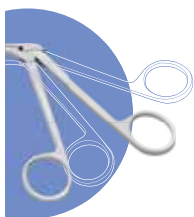

耳鼻喉科
Ear, Nose and Throat Instruments



★**ZO637RN**
190×4×15°,
弯,单头 Curved

ZO630RN
190×5,
弯,单头 Curved



ZO636RN
190×4,
直,单头 Straight

鼻中隔剥离器
Nasal raspatory

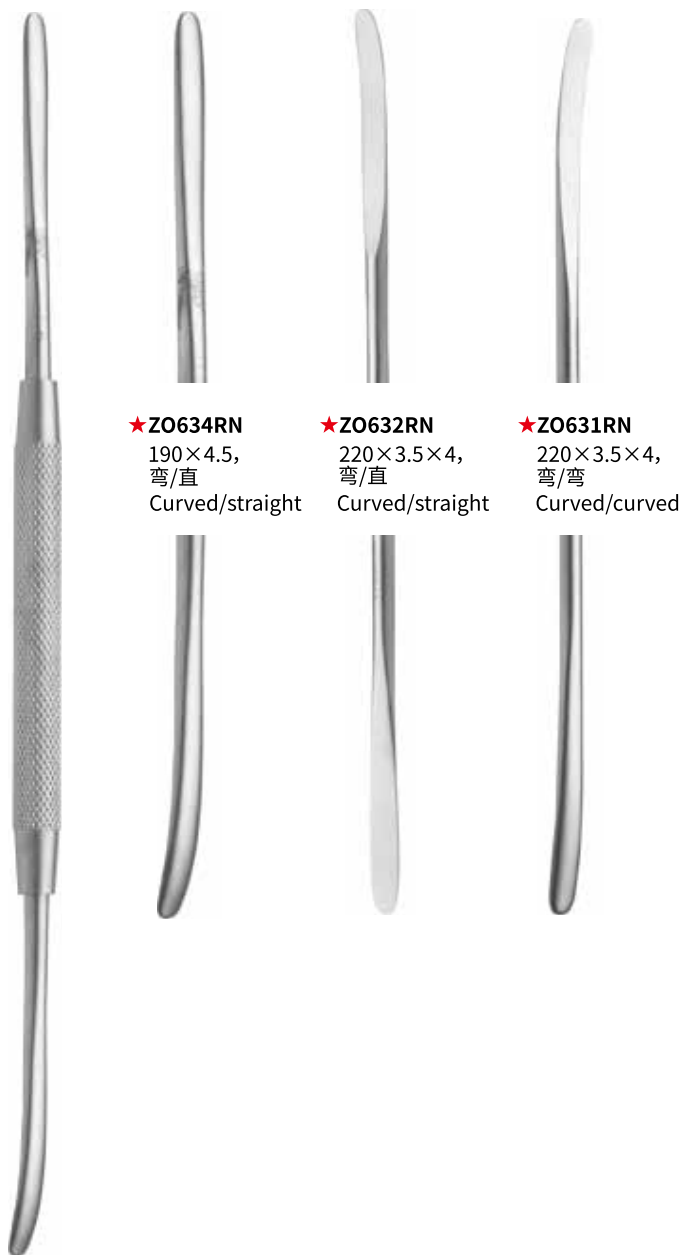

★**ZO634RN**
190×4.5,
弯/直
Curved/straight

★**ZO632RN**
220×3.5×4,
弯/直
Curved/straight

★**ZO631RN**
220×3.5×4,
弯/弯
Curved/curved

鼻中隔剥离器
Nasal raspatory

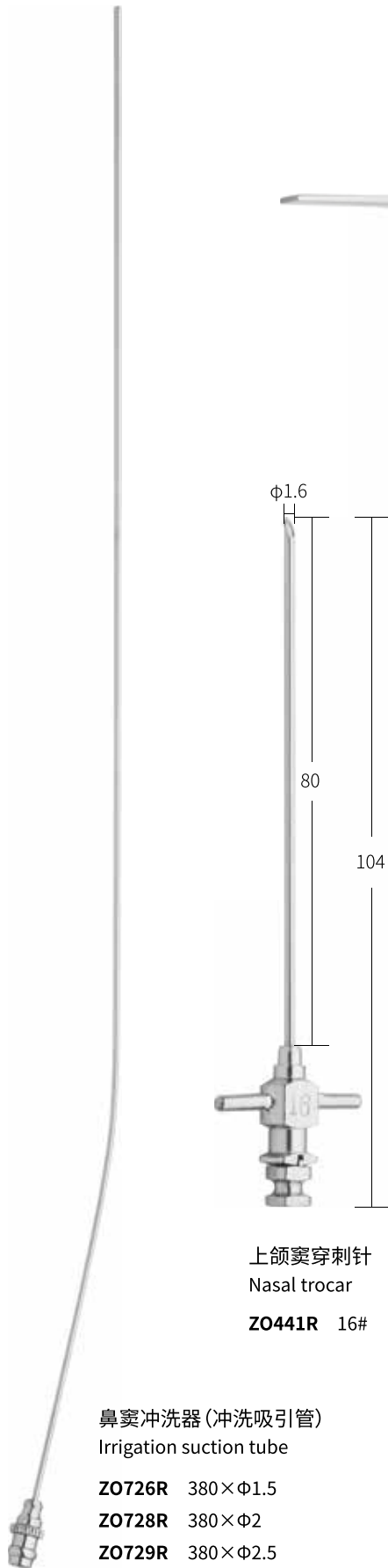

上颌窦穿刺针
Nasal trocar
ZO441R 16#

鼻窦冲洗器(冲洗吸引管)
Irrigation suction tube

- ZO726R** 380× ϕ 1.5
- ZO728R** 380× ϕ 2
- ZO729R** 380× ϕ 2.5

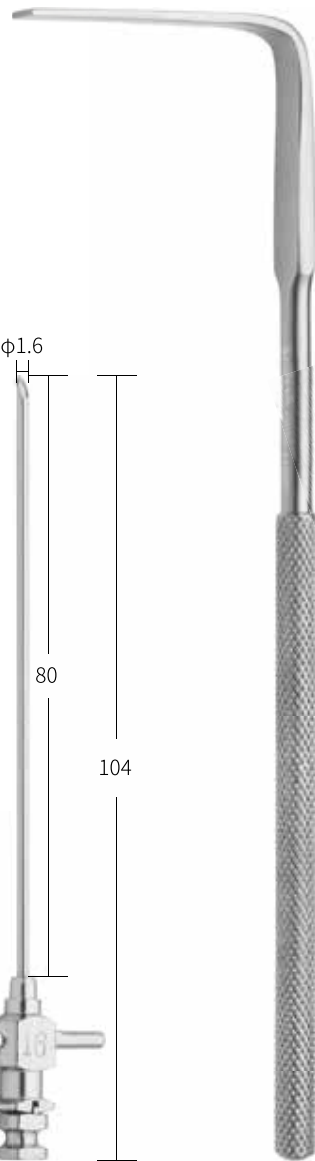

鼻腔拉钩
Nasal hook
★**ZT018RN** 160×6



鼻腔拉钩
Nasal hook
★**ZT019RN** 120, 双钩, 38×15, 53×6

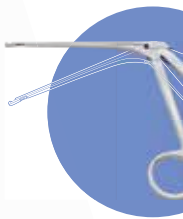

耳鼻喉科
Ear, Nose and Throat Instruments



鼻腔拉钩
Nasal hook

ZT750RB 160×7, 导光

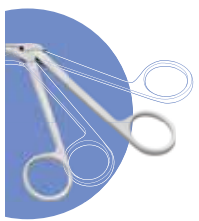

耳鼻喉科
Ear, Nose and Throat Instruments



鼻腔拉钩
Nasal hook

Z0629RN 180, 双头



上颌窦探针
Nasal probe

★**Z0439RN** 190×Φ1×Φ2



上颌窦探针

Nasal probe

ZO627RN 210×1.5×1.5, 角弯



间接喉钳

Laryngeal forceps

★ **ZO737RN** 170, 管式拆卸头 一柄三头 With 3 tips

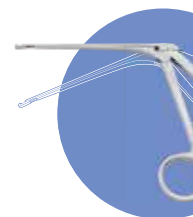

耳鼻喉科
Ear, Nose and Throat Instruments



喉用钳
 Laryngeal forceps



★ZO701RN
 240, 盖板式 上弯三角形



★ZO702RN
 240, 盖板式 直三角形

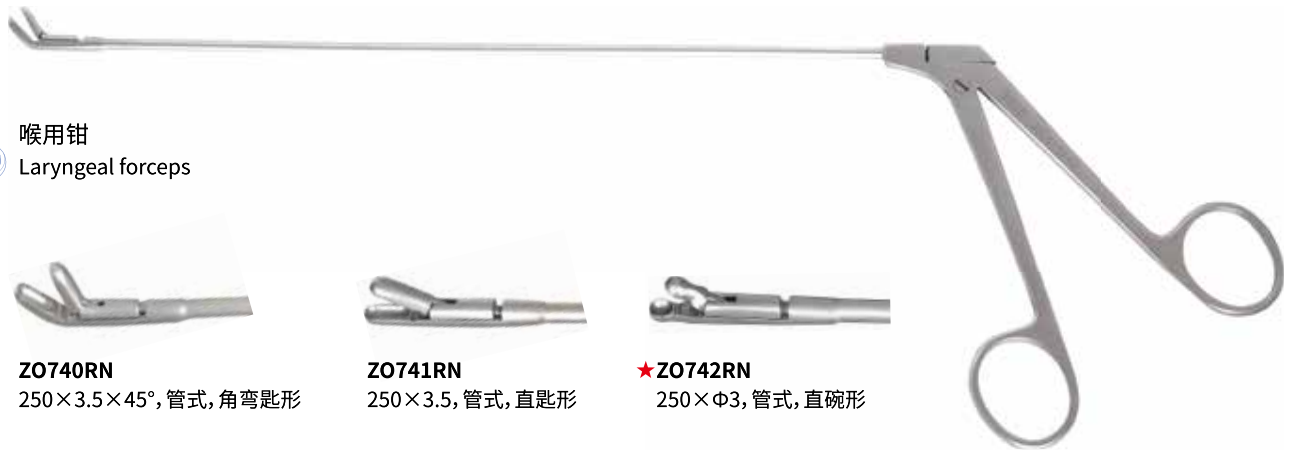

喉用钳
 Laryngeal forceps



ZO740RN
 250×3.5×45°, 管式, 角弯匙形



ZO741RN
 250×3.5, 管式, 直匙形



★ZO742RN
 250×Φ3, 管式, 直碗形



★ZO743RN
 250×Φ3×45°, 管式, 角弯碗形



★ZO744RN
 250×3, 管式, 直三角形



★ZO745RN
 250×3.5×45°, 管式, 角弯三角形



★ZO746RN
 250×4, 管式, 直左腰形
 Left concave



★ZO747RN
 250×4, 管式, 直右腰形
 Right concave



ZO748RN
 280×Φ5, 管式, 直碗形



★ZO749RN
 280×Φ5×45°, 管式, 角弯碗形

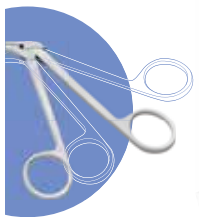

耳鼻咽喉科
 Ear, Nose and Throat Instruments

显微喉剪
Laryngeal scissors



★Z0682RN 230, 盖板式, 直

★Z0684RN 250, 盖板式, 直



★Z0683RN 230, 盖板式, 角弯

★Z0685RN 250, 盖板式, 角弯



间接喉钳
Laryngeal forceps

★Z0718RN 200, 上开 Upward opening

★Z01214RN 200, 下开 Downward opening

★Z01215RN 200, 左开 Left opening

★Z01216RN 200, 右开 Right opening

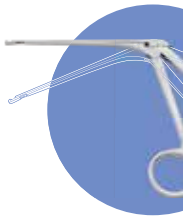

耳鼻喉科
Ear, Nose and Throat Instruments

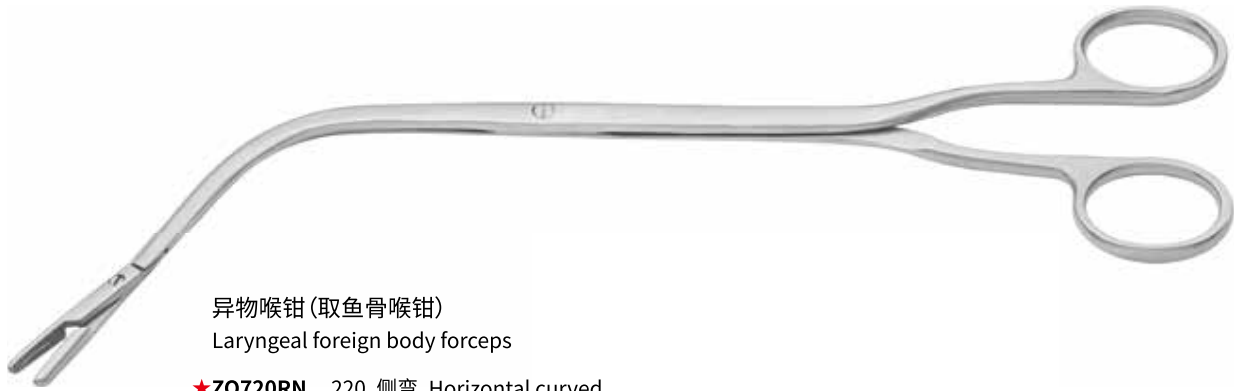

异物喉钳 (取鱼骨喉钳)
Laryngeal foreign body forceps

★Z0720RN 220, 侧弯 Horizontal curved

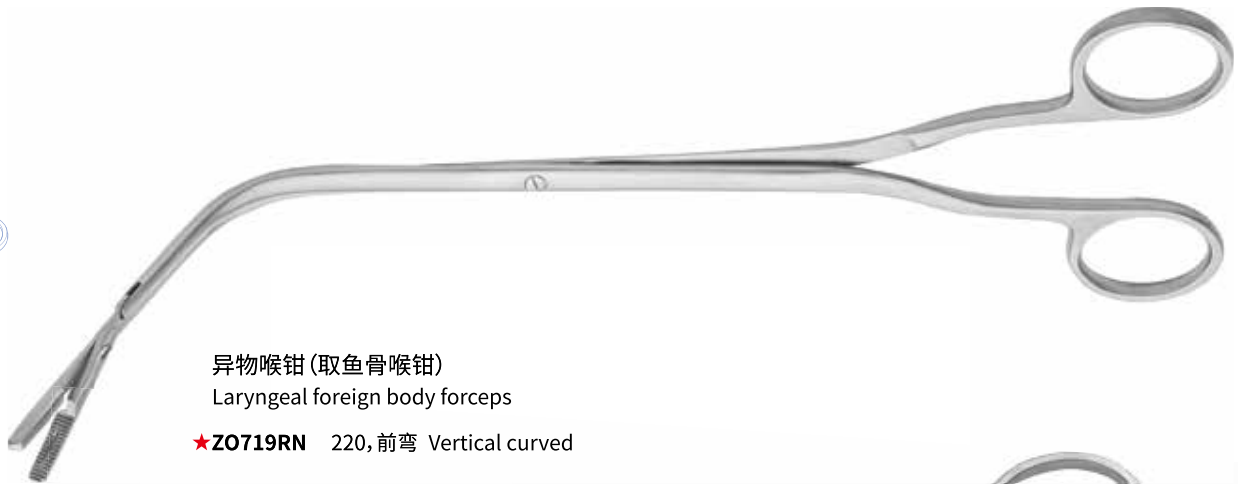

异物喉钳 (取鱼骨喉钳)
Laryngeal foreign body forceps

★Z0719RN 220, 前弯 Vertical curved



异物喉钳 (取鱼骨喉钳)
Laryngeal foreign body forceps

- ★Z0815RN 220侧弯滑板式 上开 Upward opening
- ★Z0816RN 220侧弯滑板式 下开 Downward opening
- ★Z0817RN 220侧弯滑板式 左开 Left opening
- ★Z0818RN 220侧弯滑板式 右开 Right opening

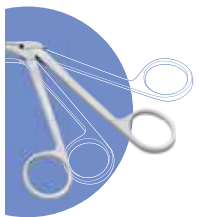

耳鼻咽喉科
Ear, Nose and Throat Instruments

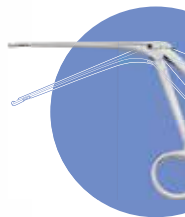
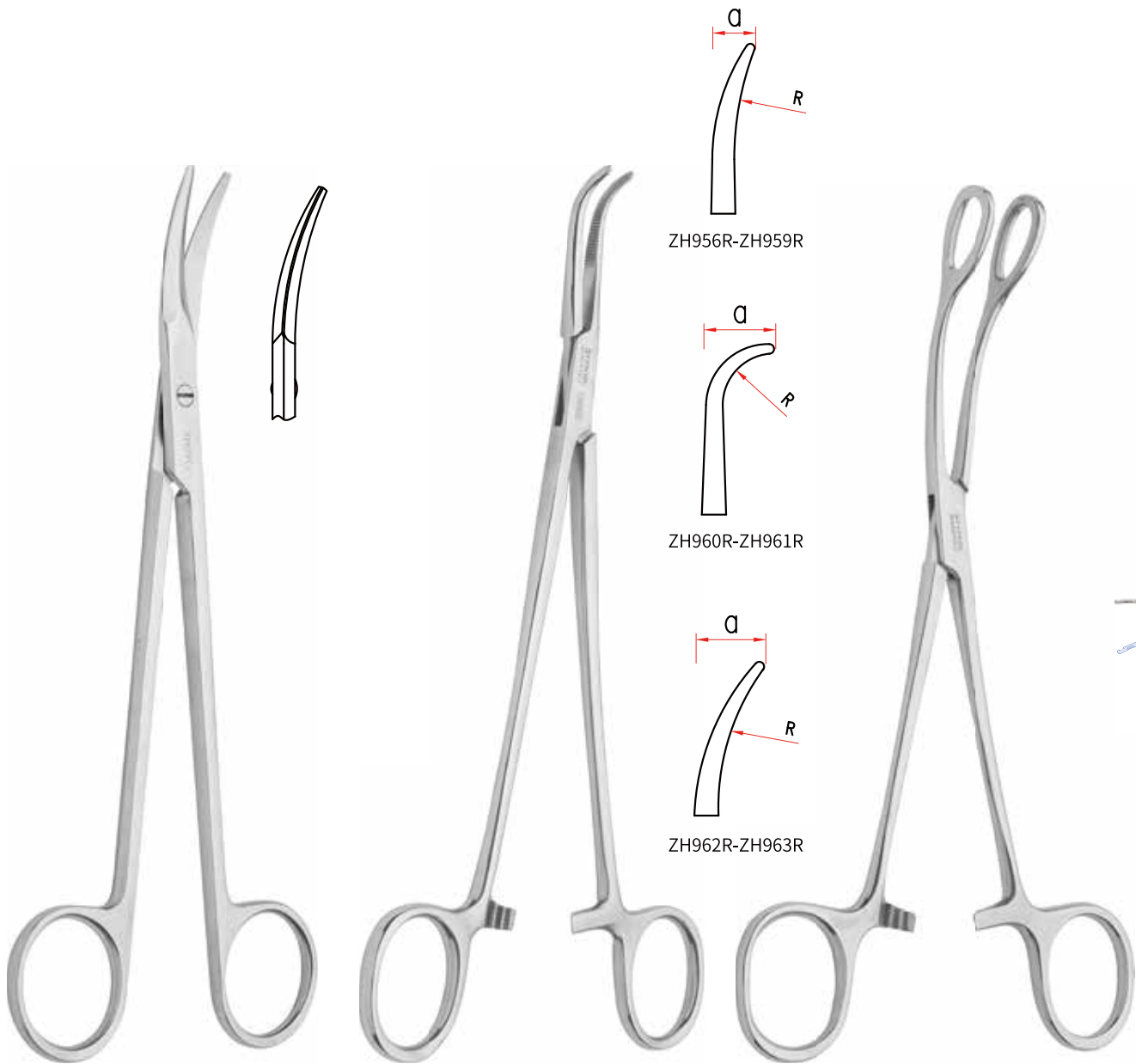

耳鼻喉科
Ear, Nose and Throat Instruments

扁桃体剪
Tonsil scissors, curved

★Z0707R/RN 180, 弯

止血钳(扁桃体用)
Tonsil hemostatic forceps

- ★ZH956R 180×R50×9×2.5, 圆弯头
- ★ZH957R 200×R50×9×2.5, 圆弯头
- ★ZH958R 220×R50×9×2.5, 圆弯头
- ★ZH959R 240×R50×9×2.5, 圆弯头
- ZH960R 180×R12×15×2.5, 圆弯头
- ★ZH961R 200×R12×15×2.5, 圆弯头
- ★ZH962R 220×R50×15×2.5, 圆弯头
- ★ZH963R 240×R50×15×2.5, 圆弯头

海绵钳(扁桃体用)
Tonsil dressing forceps

- ZH952R 180×12, 无齿, 弯 Smooth, curved
- ZH953R 180×12, 无齿, 直 Smooth, straight
- ★ZH954R 180×12, 有齿, 弯 Serrated, curved
- ★ZH955R 180×12, 有齿, 直 Serrated, straight

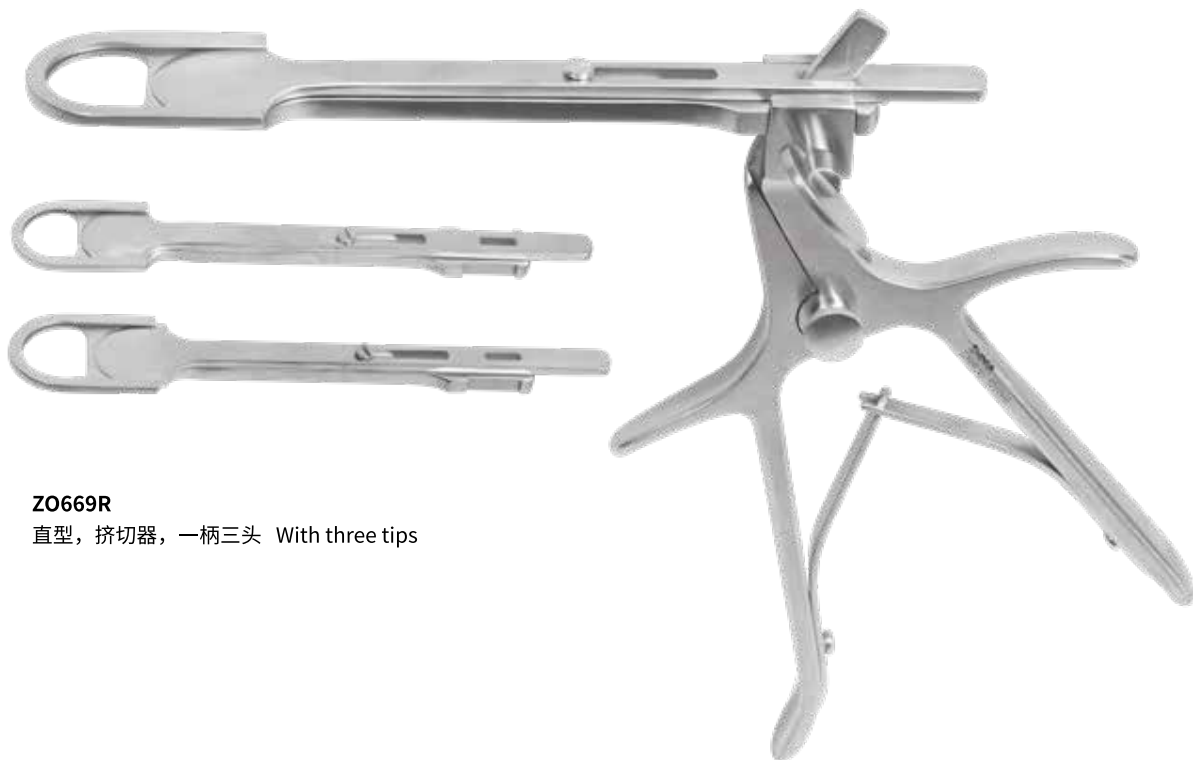

ZO669R
直型，挤切器，一柄三头 With three tips

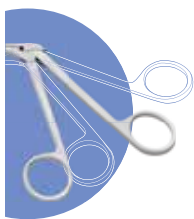

耳鼻喉科
Ear, Nose and Throat Instruments

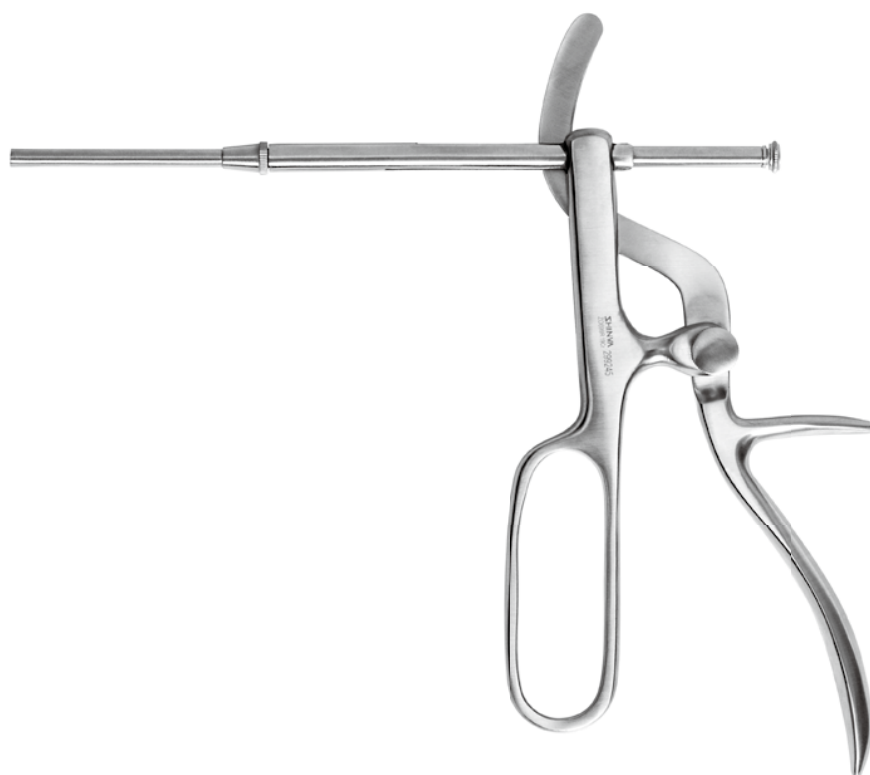

扁桃切除器
Tonsil snare

★**ZO699R** 枪形



扁桃体用钳(扁桃体夹持钳)
Tonsil grasping forceps

★ZO670R 220,多齿,直形



扁桃体用钳(扁桃体夹持钳)
Tonsil grasping forceps

★ZO671R 220,三爪,直形



扁桃体用钳(扁桃体夹持钳)
Tonsil grasping forceps

★ZO661R 135×7,三爪,枪形

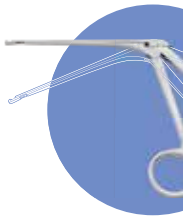

耳鼻喉科
Ear, Nose and Throat Instruments

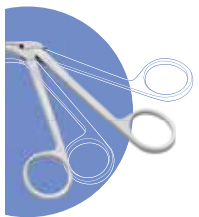

耳鼻喉科
 Ear, Nose and Throat Instruments



★Z0712R 锐 Sharp

★Z0711R 钝 Curved

扁桃体拉钩
 Tonsil retractor

扁桃体拉钩
 Tonsil retractor

★Z0662RN 225×12×10



拉钩(气管拉钩)
 Retractor

★ZT192R 170



★ZT196RN
 160×9, 三爪, 锐
 Sharp

★ZT197RN
 160×9, 三爪, 钝
 Curved

拉钩(气管拉钩)
 Retractor

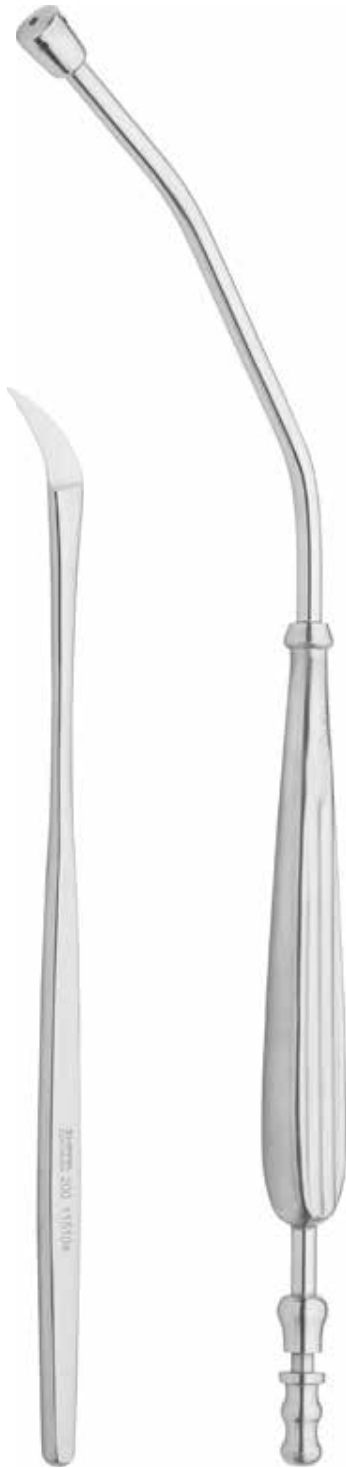

扁桃体刀
Tonsil knife

★Z0672R 200

扁桃体吸引管
Tonsil knife

★Z0673R 280×Φ6



扁桃体圈断器
Tonsil snare

★Z0710R 260, 直型



扁桃体圈断器钢丝

Snare wire

★Z0706R

Φ0.4×10, 一包10根, 一根1米
10pcs/bag, 1 meter/pc



扁桃体穿刺针
Tonsil needle

Z0676R
6# (管Φ1.2, 芯Φ0.6)
弯
Tube 1.2, insert 0.6

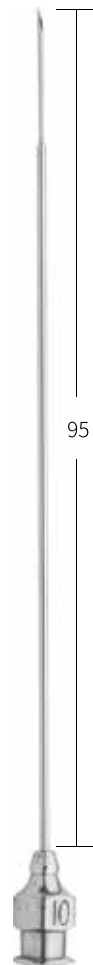

扁桃体穿刺针
Tonsil needle

Z0675R
6# (管Φ1.2, 芯Φ0.6)
直
Tube 1.2, insert 0.6

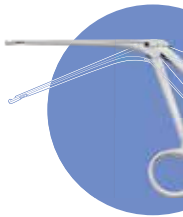

耳鼻喉科
Ear, Nose and Throat Instruments

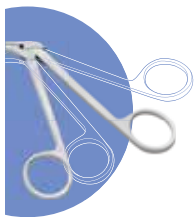

耳鼻喉科
 Ear, Nose and Throat Instruments



反光喉镜
 (咽喉镜) (口镜)
 Laryngeal mirror

- ★ZA484R 200, Φ 10 1#
- ★ZA485R 200, Φ 12 2#
- ★ZA486R 200, Φ 14 3#
- ★ZA487R 200, Φ 16 4#
- ★ZA488R 200, Φ 18 5#
- ★ZA489R 200, Φ 20 6#
- ★ZA490R 200, Φ 22 7#



卷棉子
 Cotton carrier

- ★Z0756R
 160× Φ 2
 螺纹柄三角头
- ★Z0754R
 160× Φ 1
 螺纹柄螺纹头
- ★Z0755R
 160× Φ 2
 螺纹柄螺纹头



卷棉子
 Cotton carrier

- ★Z0757R
 160× Φ 1.3, 直柄螺纹头
- ★Z0759R
 180× Φ 1.3, 直柄螺纹头
- ★Z0760R
 180× Φ 2, 直柄螺纹头
- Z0761R
 200× Φ 2, 直柄螺纹头



卷棉子
 Cotton carrier

- ★Z0758R
 160× Φ 2, 直柄三角头
- ZM452R
 200, 直柄三角头



气管套管

Tracheal tubes

- | | |
|--------------|--------------|
| ZA104 普通4mm | ZA157 普通13mm |
| ZA105 普通5mm | ZA156 普通14mm |
| ZA106 普通6mm | ZA160 短型8mm |
| ZA107 普通7mm | ZA161 短型9mm |
| ZA108 普通8mm | ZA162 短型10mm |
| ZA109 普通9mm | ZA163 短型11mm |
| ZA110 普通10mm | ZA164 短型12mm |
| ZA159 普通11mm | ZA165 短型13mm |
| ZA158 普通12mm | |



气管扩张钳

Tracheal dilating forceps

★ZA005R 150



气管导管夹持钳

Catheter introducing forceps

★ZJ023R 成人, 180
Adult



气管导管夹持钳

Catheter introducing forceps

★ZJ022R 儿童, 170
Child



气管导管夹持钳

Catheter introducing forceps

★ZJ021R 婴幼儿, 140
Infant



耳鼻喉科
Ear, Nose and Throat Instruments



气管扩张钳(三翼)
Tracheal dilating forceps
★ZA009RN 150



气管扩张钳
Tracheal dilating forceps
★ZA003RN 200, 弯型

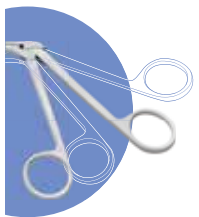

耳鼻喉科
Ear, Nose and Throat Instruments



舌钳
Tongue forceps
★ZA709R 170



甲状腺剪
Valsellum scissors, curved
★ZC632R 180弯



丁字式开口器
Heister mouth gag

★ZO030R 130



口腔开口器 (钳式)
Mouth gag

★ZR809R 120×38, 最大开口36
Max. opening 36



口腔开口器 (框式)
Mouth gag

★ZR812RN (共3把拉钩)
With three retractors

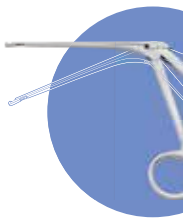

耳鼻喉科
Ear, Nose and Throat Instruments

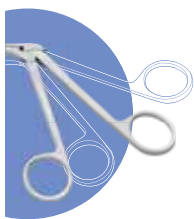

耳鼻喉科
Ear, Nose and Throat Instruments



口腔开口器 (麻醉型)
Mouth gag

★Z0723RN
右式 (共4把拉钩)
Right, with 4 retractors



口腔开口器 (麻醉型)
Mouth gag

★Z0722RN
左式 (共4把拉钩)
Left, with 4 retractors



口腔开口器 (麻醉型)
Mouth gag

★Z0868RN
小儿, 右式
Child, right



口腔开口器 (麻醉型)
Mouth gag

★Z0869RN
小儿, 左式
Child, left

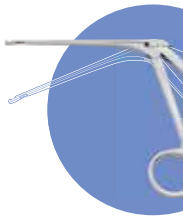

耳鼻喉科
Ear, Nose and Throat Instruments

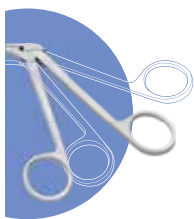

耳鼻喉科
Ear, Nose and Throat Instruments



口腔开口器 (麻醉型)
Mouth gag

★ZO867RN
左式 Left

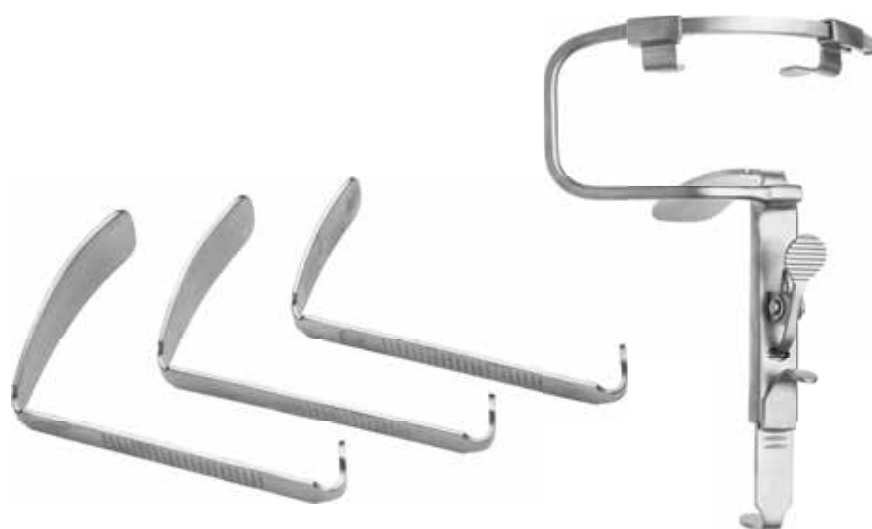

口腔开口器 (麻醉型)
Mouth gag

★ZO866RN
右式 Right



口腔开口器 (麻醉型)
Mouth gag

★ZR813R
左式, 简易型 Left



口腔开口器 (麻醉型)
Mouth gag

★ZR814R
右式, 简易型 Right

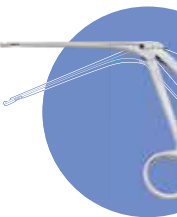

耳鼻喉科
Ear, Nose and Throat Instruments

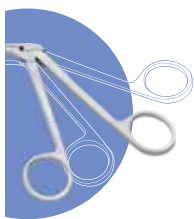

耳鼻喉科
Ear, Nose and Throat Instruments



口腔开口器 (新型)
Mouth gag

ZR810RN
KQ- I 型



口腔开口器 (新型)
Mouth gag

ZR811RN
KQ- II 型

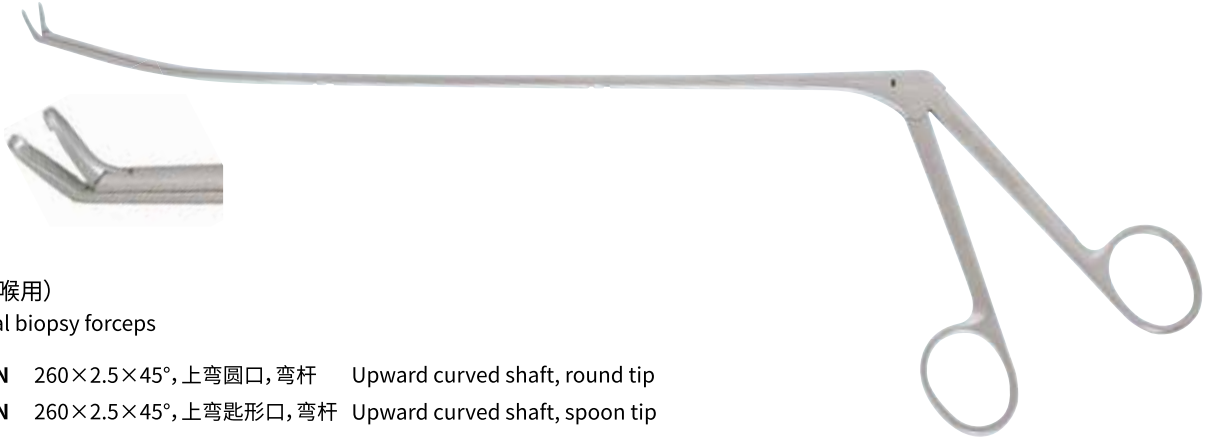

活检钳(喉用)
Laryngeal biopsy forceps

- ZO780RN** 260×2.5×45°, 上弯圆口, 弯杆 Upward curved shaft, round tip
- ZO782RN** 260×2.5×45°, 上弯匙形口, 弯杆 Upward curved shaft, spoon tip



活检钳(喉用)
Laryngeal biopsy forceps

- ZO779RN** 260×2.5×45°, 上弯圆口, 直杆 Straight shaft, round tip
- ZO781RN** 260×2.5×45°, 上弯匙形口, 直杆 Straight shaft, spoon tip
- ZO783RN** 260×4×45°, 上弯三角形



异物喉钳
Laryngeal foreign body forceps

- ZO778RN** 280×3, 直齿头, 右开口 Right opening
- ZO777RN** 280×3, 直齿头, 左开口 Left opening
- ZO776RN** 280×3, 直齿头, 下开口 Downward opening
- ZO775RN** 280×3, 直齿头, 上开口 Upward opening

耳鼻喉科
Ear, Nose and Throat Instruments

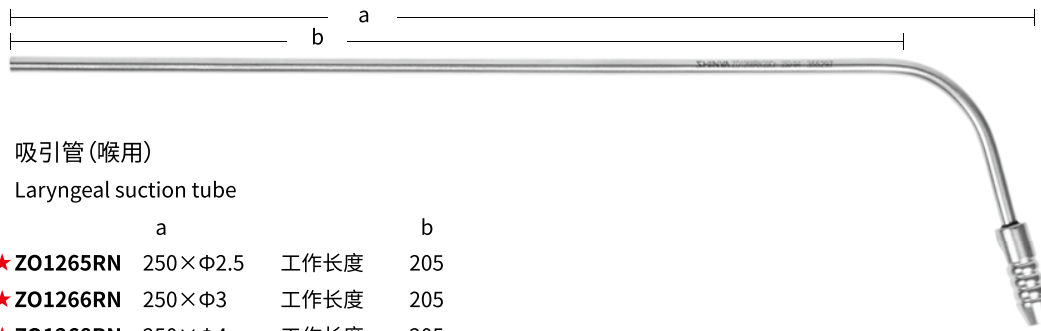

吸引管(喉用)

Laryngeal suction tube

	a		b
★ ZO1265RN	250×Φ2.5	工作长度	205
★ ZO1266RN	250×Φ3	工作长度	205
★ ZO1268RN	250×Φ4	工作长度	205

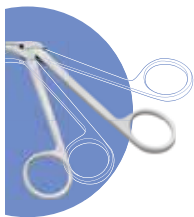

耳鼻喉科
 Ear, Nose and Throat Instruments

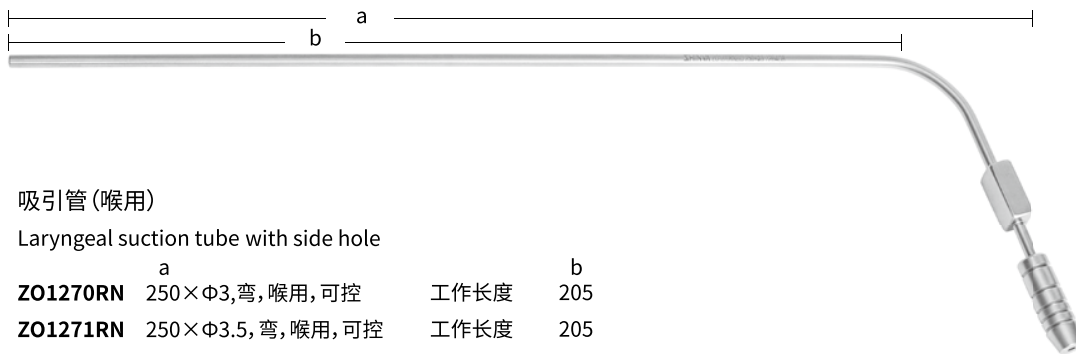

吸引管(喉用)

Laryngeal suction tube with side hole

	a		b
ZO1270RN	250×Φ3, 弯, 喉用, 可控	工作长度	205
ZO1271RN	250×Φ3.5, 弯, 喉用, 可控	工作长度	205
ZO1272RN	250×Φ4, 弯, 喉用, 可控	工作长度	205

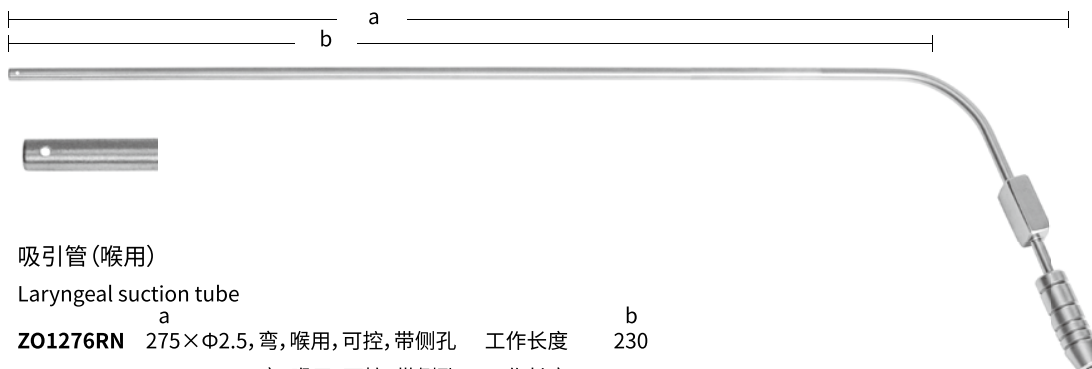

吸引管(喉用)

Laryngeal suction tube

	a		b
ZO1276RN	275×Φ2.5, 弯, 喉用, 可控, 带侧孔	工作长度	230
ZO1277RN	275×Φ3, 弯, 喉用, 可控, 带侧孔	工作长度	230
ZO1278RN	275×Φ3.5, 弯, 喉用, 可控, 带侧孔	工作长度	230
ZO1279RN	275×Φ4, 弯, 喉用, 可控, 带侧孔	工作长度	230



异物钳 (气管异物钳)
 Tracheal foreign body forceps



Z0792RN
 360×Φ2.5, 反二爪式



Z0793RN
 360×Φ2.5, 三爪式



Z0794RN
 360×Φ2.5, 三爪取笔套式



Z0795RN
 360×2.5×Φ2.5, 前爪口



Z0796RN
 360×2.5×Φ2.5, 花生米头



Z0797RN
 360×3×Φ2.5, 二爪式



Z0798RN
 360×3×Φ2.5, 环形口

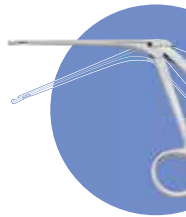

耳鼻喉科
 Ear, Nose and Throat Instruments



异物钳 (气管异物钳)
 Tracheal foreign body forceps



Z0784RN
 360×2.5×Φ2, 锯齿头



Z0785RN
 360×2.5×Φ2, 圆口



Z0786RN
 360×2.5×Φ2, 麦粒头



Z0787RN
 360×2.5×Φ2, 取珠式



Z0788RN
 360×2.5×Φ2, 环形头



Z0789RN
 360×Φ2, 取笔套式



Z0790RN
 360×Φ2, 鳄鱼嘴头



Z0791RN
 360×Φ2, 尖头式

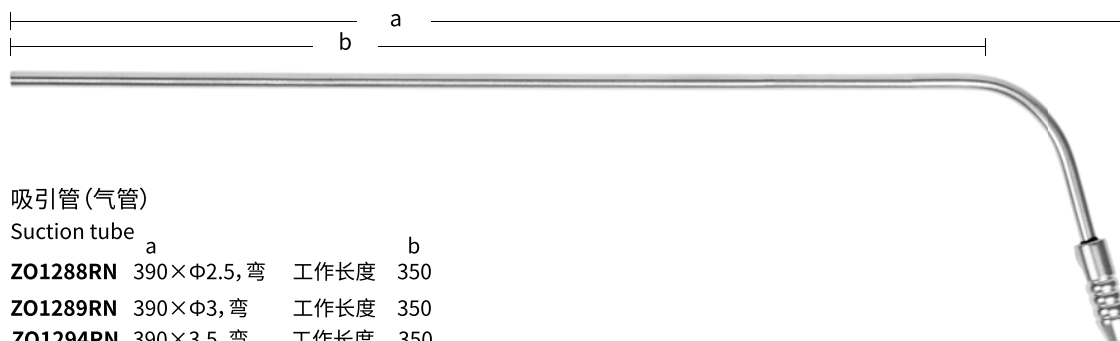

吸引管(气管)

Suction tube

	a	工作长度	b
ZO1288RN	390×Φ2.5, 弯	350	350
ZO1289RN	390×Φ3, 弯	350	350
ZO1294RN	390×Φ3.5, 弯	350	350
ZO1290RN	390×Φ4, 弯	350	350

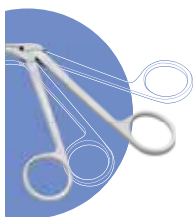

耳鼻喉科
 Ear, Nose and Throat Instruments



食道贲门狭窄扩张器
 Cardia expander

ZO3959R	9×13×250	ZO3962R	12×17×380
ZO3960R	10×15×300	ZO3963R	13×18×400
ZO3961R	11×16×350		



快装手柄
 Quick coupling handle

ZO3964R	105, 可换	Exchangable
----------------	---------	-------------



异物钳 (气管异物钳)
Tracheal foreign body forceps

- ZO807RN** 350×Φ4, 倒齿头, 可转式
- ZO808RN** 380×Φ4, 倒齿头, 可转式
- ZO809RN** 450×Φ4, 倒齿头, 可转式
- ZO810RN** 500×Φ4, 倒齿头, 可转式



异物钳 (气管异物钳)
Tracheal foreign body forceps



- ZO799RN** 350×Φ4, 鳄鱼头
- ZO800RN** 380×Φ4, 鳄鱼头
- ZO801RN** 450×Φ4, 鳄鱼头
- ZO802RN** 500×Φ4, 鳄鱼头

- ZO811RN** 350×Φ4, 抱合头
- ZO812RN** 380×Φ4, 抱合头
- ZO813RN** 450×Φ4, 抱合头
- ZO814RN** 500×Φ4, 抱合头

- ZO803RN** 350×Φ4, 倒齿头
- ZO804RN** 380×Φ4, 倒齿头
- ZO805RN** 450×Φ4, 倒齿头
- ZO806RN** 500×Φ4, 倒齿头

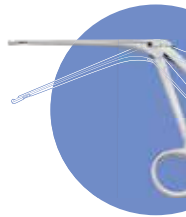

耳鼻喉科
Ear, Nose and Throat Instruments

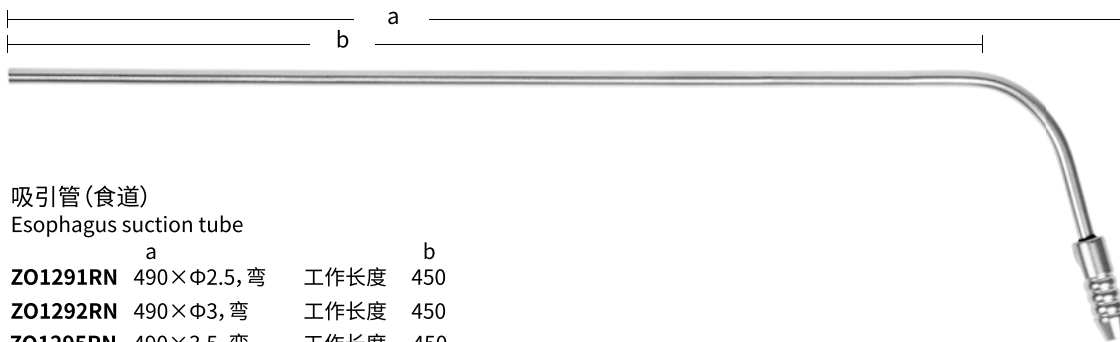

吸引管 (食道)
Esophagus suction tube

- | | a | b |
|-----------------|-------------|----------|
| ZO1291RN | 490×Φ2.5, 弯 | 工作长度 450 |
| ZO1292RN | 490×Φ3, 弯 | 工作长度 450 |
| ZO1295RN | 490×Φ3.5, 弯 | 工作长度 450 |
| ZO1293RN | 490×Φ4, 弯 | 工作长度 450 |



手术剪 (食道剪)
Esophagus scissors

- ZO820RN** 450×Φ3.5, 管式, 直



息肉钳(食道息肉钳)
 Esophagus forceps,bowl-shape
 upwards curved 45°

ZO644RN 450×Φ3.5, 上翘45°, 碗形

活检钳(食道活检钳)
 Esophagus forceps,bowl-shape
 right curved

ZO641RN 450×Φ3.5, 右弯, 碗形



异物钳(食道异物钳)
 Esophagus foreign body forceps

ZO819RN 380×Φ4, 切除



活检钳(食道活检钳)
 Esophagus forceps,bowl-shape
 left curved

ZO640RN 450×Φ3.5, 左弯, 碗形

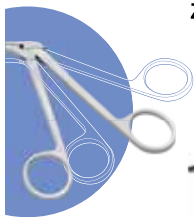

耳鼻喉科
 Ear, Nose and Throat Instruments



息肉钳(食道息肉钳)
 Esophagus forceps

ZO643RN 450×Φ3.5, 右弯, 匙形
 Right curved

ZO645RN 450×Φ3.5, 直, 匙形
 Straight



活检钳(食道活检钳)
 Esophagus forceps,bowl-shape

ZO642RN 450×Φ3.5, 旋转, 碗形 Rotatable

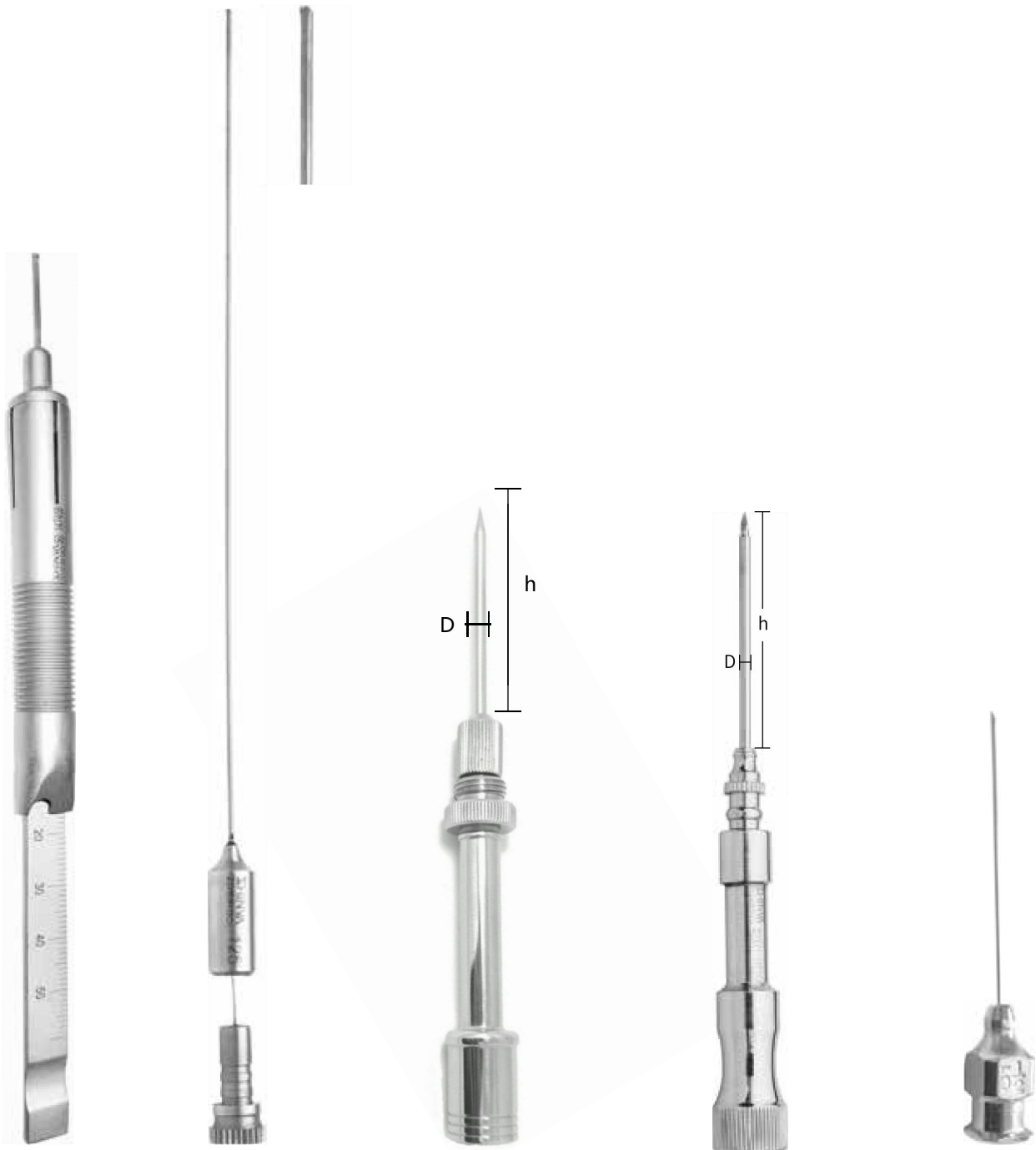

耳鼻喉科
 Ear, Nose and Throat Instruments

测深器
 Depth gauge
ZO357R 50

测量器
 Gauge
ZO151R 125

环甲膜穿刺针
 Cricothyroid needle
 connected to ventilator
D × h
 ZO1285R Φ3.0×46
 ZO1286R Φ4.0×46

环甲膜穿刺针
 Cricothyroid needle
D × h
 ZO090R Φ2.1×41
 LS409R Φ2.4×41
 ZO091R Φ3 × 41
 LS499R Φ6 × 48

经皮穿刺针 (鼓膜穿刺针)
 Eardrum needle
 ZO1296R 0.5×80
 ZO1297R 0.6×80
 ZO1298R 0.7×80
 ZO1299R 0.8×80
 ZO1300R 0.9×80

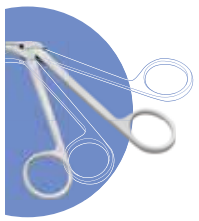

耳鼻喉科
Ear, Nose and Throat Instruments



压舌板
Tongue depressor

★ZO204R 170



压舌板
Tongue depressor

★ZO203R 160



压舌板
Tongue depressor, right angle

★ZO611R 直角形



甲状腺拉钩
Retractor

★ZT024R/RN
95, 10×20/10×29, 一副
2 pcs/pair



甲状腺拉钩
Retractor

★ZT025R/RG
117, 10×23/10×35
★ZT026R/RG
120, 10×25/10×37
★ZT028R/RN
(117, 120) 一副 2 pcs/pair
ZT040R
126, 9×23/12×32 一副
2 pcs/pair

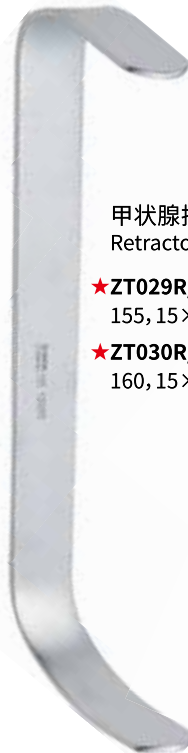

甲状腺拉钩
Retractor

★ZT029R/RN
155, 15×33/15×42
★ZT030R/RN
160, 15×38/15×47



甲状腺拉钩
Retractor

★ZT031R
200, 13×39/13×43
一副, 带槽 2 pcs/pair
ZT035R
210, 15×30/15×45
一副, 带槽 2 pcs/pair

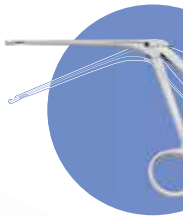

耳鼻喉科
Ear, Nose and Throat Instruments

编码后缀注释: R—电镀 RN—亚光无镀层 RB—刷光无镀层

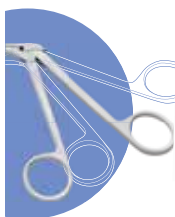

耳
鼻
喉
科
Ear, Nose and Throat Instruments

DW- I 型耳鼻喉科手术器械包(丁种外科器械包) (ZO100)

DW-I ENT Surgical Instruments set

序号	编码	名称	规格	单位	数量
1	ZH110R	止血钳	125,直蚊,全齿	把	2
2	ZH145R	止血钳	140,弯,全齿	把	2
3	ZH443R	止血钳	160,弯,全齿	把	2
4	ZM240R	持针钳	140,直,细针	把	1
5	ZA709R	舌钳	170,直	把	1
6	ZB084R	手术刀柄	4#	把	1
7	ZB077R	手术刀柄	7#	把	1
8	ZC344R	手术剪	140,直尖	把	1
9	ZC414R	手术剪	140,弯圆	把	1
10	ZD045R	医用镊	125,直	把	6
11	ZO030R	丁字式开口器	130	把	1
12	ZO081R	鼻窥器	150×28	把	1
13	ZM113R	探针	120,双头	支	1
14	ZO203R	压舌板	160,直形	块	1
15	ZR022R	牙用镊	160,单弯,有定位	把	1



QG- I 型气管切开手术器械(ZA100)
 QG- I tracheotomy instruments set

序号	编码	名称	规格	单位	数量
1	ZH110R	止血钳	125,直蚊	把	3
2	ZH111R	止血钳	125,弯蚊	把	3
3	ZH144R	止血钳	140,直全	把	3
4	ZH145R	止血钳	140,弯全	把	3
5	ZH443R	止血钳	160,弯全	把	1
6	ZM240R	持针钳	140,细针	把	1
7	ZD045R	医用镊	125	把	1
8	ZD047R	医用镊	140	把	2
9	ZD557R	组织镊	140,不锈钢	把	1
10	ZE432R	帕巾钳	110	把	4
11	ZC547R	组织剪	180,直	把	1
12	ZB073R	手术刀柄	3#	把	1
13	ZB077R	手术刀柄	7#	把	1
14	ZB515	手术刀片	15#	包	1

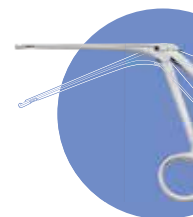

耳鼻喉科
 Ear, Nose and Throat Instruments

序号	编 码	名 称	规 格	单 位	数 量
15	ZA005R	气管扩张钳	150	把	1
16	ZT028R	甲状腺拉钩	(117, 120) 一副	副	1
17	ZT192R	拉钩	170, 气管	把	2
18	ZA107	气管套管	7#	套	1
19	ZA108	气管套管	8#	套	1
20	ZA109	气管套管	9#	套	1
21	ZA110	气管套管	10#	套	1

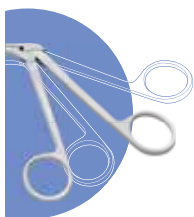

耳鼻喉科
Ear, Nose and Throat Instruments



环甲膜切开成套手术器械 (ZA101)
Cricothyroid instruments set

序号	产品编码	产品名称	规格型号	数量	单位
1	ZB073R	手术刀柄	3#	1	把
2	ZB077R	手术刀柄	7#	1	把
3	ZA005R	气管扩张钳	150, 弯型	1	把
4	ZH144R	止血钳	140, 直, 全齿	1	把
5	ZH145R	止血钳	140, 弯, 全齿	1	把
6	ZO090R	经皮穿刺针	2.1*41 (环甲膜)	1	把
7	ZO091R	经皮穿刺针	3.0*41 (环甲膜)	1	把
8	LS409R	经皮穿刺针	2.4*41 (环甲膜)	1	把
9	ZB515	手术刀片	15#	1	包

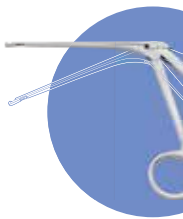

耳鼻喉科
Ear, Nose and Throat Instruments



JM-I型静脉切开手术器械包(ZB140)
 JM-I venotomy instruments set

序号	编码	名称	规格	单位	数量
1	ZH110R	止血钳	125,直蚊	把	1
2	ZH111R	止血钳	125,弯蚊	把	1
3	ZE431R	帕巾钳	90	把	2
4	ZC056R	眼用剪	100,直尖	把	1
5	ZB073R	手术刀柄	3#	把	1
6	ZD555R	组织镊	125,不锈钢	把	1
7	ZB515	手术刀片	15#	包	1
8	ZT184R	拉钩	200×13,静脉	把	1
9	ZM666R	缝合针	1/2,弯三角,8×20	包	1

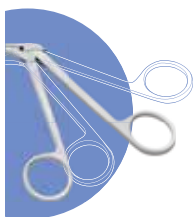

耳鼻喉科
 Ear, Nose and Throat Instruments



EK-I 型耳科显微手术器械包明细表 (ZO199)
EK-I ear surgical instruments set

序号	编码	名称	规格	单位	数量
1	ZO183R	显微剥离器	160×1, 弯型, 叶片状	把	1
2	ZO184R	耳刮匙	160×1.8, 单头, 圆头	把	1
3	ZO185R	耳刮匙	160×2, 单头, 圆头	把	1
4	ZO176R	耳道皮瓣刀	160×2.5×45°, 角弯	把	1
5	ZO187R	耳道皮瓣刀	160×2.4 耳横切口	把	1
6	ZO188R	显微剥离器	160×0.9 右弯, 耳开窗	把	1
7	ZO189R	显微剥离器	160×0.9 左弯, 耳开窗	把	1
8	ZO190R	耳用骨凿	160×1.7×0.85, 直, 圆刃	把	1
9	ZO191R	耳用骨凿	160×2×1.6, 弯, 圆刃	把	1
10	ZO192R	耳用骨凿	160×0.6×0.3, 直, 平刃	把	1
11	ZO193R	显微耳针	160×1, 直型, 尖头	把	1
12	ZO182R	耳道皮瓣刀	160, 镰状	把	1
13	ZO195R	耳道皮瓣刀	160×2.2, 直型, 耳切口	把	1
14	ZO196R	耳道皮瓣刀	160×1.2, 直型, 耳开窗	把	1
15	ZO197R	耳道皮瓣刀	160×1.2, 弯型, 耳开窗	把	1
16	ZO123R	显微耳针	160, 直型, 尖头	把	1
17	ZO205R	耳钩	160×2, 直形, 角弯90°, 钝钩	把	1
18	ZO206R	耳钩	160×2, 直形, 角弯90°, 锐钩	把	1

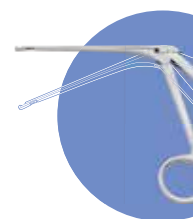

耳鼻喉科
Ear, Nose and Throat Instruments

序号	编 码	名 称	规 格	单 位	数 量
19	ZO207R	耳钩	160×1.5,直形,角弯120°,锐钩	把	1
20	ZO208R	耳钩	160×1.5,直形,角弯95°,锐钩	把	1
21	ZO209R	耳钩	160×2.5,直形,角弯95°,锐钩	把	1

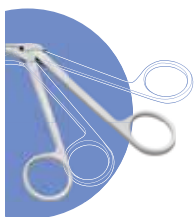

耳鼻喉科
Ear, Nose and Throat Instruments



EK—II型耳科显微手术器械包明细表 (ZO201)

EK—II ear surgical instruments set

序号	编 码	名 称	规 格	单 位	数 量
1	ZO123R	显微耳针	160,直型,尖头	把	1
2	ZO124R	显微耳针	160×45°,角弯,尖头	把	1
3	ZO125R	显微耳钩	160×0.3×90°,直型	把	1
4	ZO126R	显微耳钩	160×0.6×90°,直型	把	1
5	ZO127R	显微耳钩	160×1×90°,直型	把	1
6	ZO128R	显微耳针	160×0.5,直型,尖头	把	1
7	ZO138R	耳用骨凿	160×2×1,直,圆刃	把	1
8	ZO149R	吸引头	50,微型	个	2
9	ZO150R	骨撬	145,直型,耳用	把	1
10	ZO151R	测深器	125	把	1
11	ZO152R	耳刮匙	160×2,单头,椭圆头	把	1
12	ZO153R	耳刮匙	160×2,双头	把	1

序号	编码	名称	规格	单位	数量
13	ZO154R	耳刮匙	160×1.5, 双头	把	1
14	ZO164R	显微剥离器	160×1.5, 弯型, 叶片状	把	1
15	ZO165R	显微剥离器	160×2, 弯型, 叶片状	把	1
16	ZO176R	耳道皮瓣刀	160×2.5×45°, 角弯	把	1
17	ZO182R	耳道皮瓣刀	160, 镰状	把	1
18	ZO210R	耳道皮瓣刀	160×2.5, 直型	把	1
19	ZO211R	耳道皮瓣刀	160×2×45°, 角弯	把	1
20	ZO132R	乳突牵开器	130, 3×3钩, 钝钩, 固定式	把	1
21	ZV073RG	乳突牵开器	170×21, 3×3钝钩, 活节带齿	把	2
22	ZO173R	镮骨足弓剪	75, 左上翘	把	1
23	ZO174R	镮骨足弓剪	75, 右上翘	把	1
24	ZO169R	镮骨钳	80, 安装用	把	1
25	ZO181R	耳用槌骨咬骨剪	80, 直	把	1
26	ZO166R	耳钳	80, 直, 橄榄形, 显微	把	1
27	ZO167R	耳钳	80, 直, 碗形, 显微	把	1
28	ZO168R	耳钳	80, 直, 麦粒形, 显微	把	1
29	ZO3820RB	耳剪	80, 直	把	1

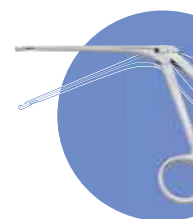

耳鼻喉科
Ear, Nose and Throat Instruments

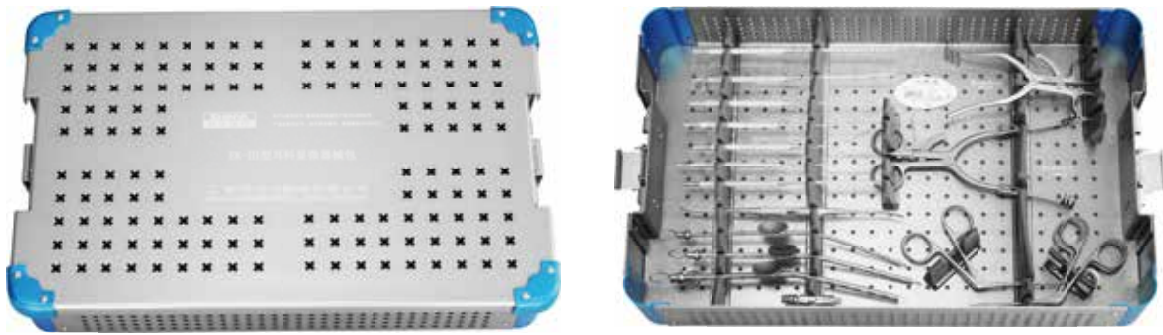

EKV-III型耳科显微手术器械包明细表 (ZO202)
 EKV-III ear surgical instruments set

序号	编码	名称	规格	单位	数量
1	ZO126R	耳钩	160×0.6	把	1
2	ZO138R	耳用骨凿	160×2×1, 圆刃	把	1
3	ZO150R	骨撬	145, 直, 耳用	把	1
4	ZO165R	显微剥离器	160×2, 剥离子	把	1
5	ZO176R	耳道皮瓣刀	160×2.5×45°角弯	把	1
6	ZO132R	乳突牵开器	130, 固定式, 3×3钩, 钝钩	把	1
7	ZV073RG	乳突牵开器	170×21, 3×3钝钩	把	1
8	ZO181R	耳用锤骨咬骨剪	80	把	1
9	ZO166R	耳钳	80, 显微, 橄榄形	把	1
10	ZO168R	耳钳	80, 显微, 直麦粒形	把	1
11	ZO3820RB	耳剪	80, 直	把	1
12	ZO207R	耳钩	160×1.5, 角弯120°	把	1
13	ZO208R	耳钩	160×1.5, 角弯95°	把	1
14	ZO122R	鼻骨膜剥离器	190×4×4, 弯	把	1
15	ZO149R	吸引头	50	把	1
16	ZO135R	吸引管	190×φ3, 乳突	把	1
17	ZO136R	吸引管	190×φ4, 乳突	把	1
18	ZO137R	吸引管	190×φ5, 乳突	把	1

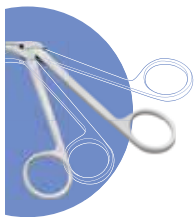

耳鼻喉科
 Ear, Nose and Throat Instruments



耳道皮瓣刀套装 (ZO3818)
 Ear flap knives set

序号	产品编码	产品名称	规格型号	数量	单位
1	ZO3801RB	耳道皮瓣刀	160×1×45°, 角弯	1	把
2	ZO3802RB	耳道皮瓣刀	160×1.2×45°, 角弯	1	把
3	ZO3803RB	耳道皮瓣刀	160×1.5×45°, 角弯	1	把
4	ZO3804RB	耳道皮瓣刀	160×1.8×45°, 角弯	1	把
5	ZO3805RB	耳道皮瓣刀	160×2×45°, 角弯	1	把
6	ZO3806RB	耳道皮瓣刀	160×2.5×45°, 角弯	1	把
7	ZO3807RB	耳道皮瓣刀	160×3×45°, 角弯	1	把
8	ZO3808RB	耳道皮瓣刀	160×1×90°, 角弯	1	把
9	ZO3809RB	耳道皮瓣刀	160×1.2×90°, 角弯	1	把
10	ZO3810RB	耳道皮瓣刀	160×1.5×90°, 角弯	1	把
11	ZO3811RB	耳道皮瓣刀	160×1.8×90°, 角弯	1	把
12	ZO3812RB	耳道皮瓣刀	160×2×90°, 角弯	1	把
13	ZO3813RB	耳道皮瓣刀	160×2.5×90°, 角弯	1	把
14	ZO3814RB	耳道皮瓣刀	160×2, 直型	1	把
15	ZO3815RB	耳道皮瓣刀	160×2.5, 直型	1	把
16	ZO3816RB	耳道皮瓣刀	160, 镰状	1	把
17	ZO3817RB	耳道皮瓣刀	160, 镰状	1	把
18	ZO20027P	消毒盒	262×162×42 双层	1	个

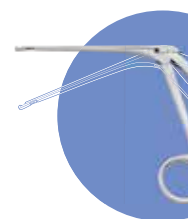

耳鼻喉科
 Ear, Nose and Throat Instruments



耳科显微外科手术器械包 (ZO4000)
Ear surgical instruments set

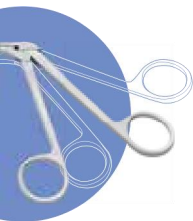

耳鼻咽喉科
Ear, Nose and Throat Instruments

序号	产品编码	产品名称	规格型号	数量	单位
1	ZO3885T	剥离器	165×Φ1.5×10×90°, 带吸引	1	把
2	ZO3888T	剥离器	162×Φ1.2×3.5×45°, 带吸引	1	把
3	ZO3889T	剥离器	162×Φ1.2×3.5×45°, 带吸引	1	把
4	ZO3890T	剥离器	160×Φ1.5×1.5×45°, 带钩, 带吸引	1	把
5	ZO3891T	剥离器	160×Φ1.5×2.0×45°, 带钩, 带吸引	1	把
6	ZO3892T	剥离器	160×Φ1.5×2.5×45°, 带钩, 带吸引	1	把
7	ZO3893T	剥离器	168×Φ1.5×5.5×45°, 带吸引	1	把
8	ZO3894T	剥离器	168×Φ1.5×5.5×45°, 带吸引	1	把
9	ZO3895T	剥离器	160×Φ1.5×2.2×60°, 圆刃, 带吸引	1	把
10	ZO3896T	剥离器	160×Φ1.5×2.6×60°, 圆刃, 带吸引	1	把
11	ZO3897T	剥离器	160×2.3, 圆刃, 带吸引	1	把
12	ZO3898T	剥离器	160×2.3, 圆刃, 带吸引	1	把
13	ZO3899T	剥离器	160×1.8, 铲型, 带吸引	1	把
14	ZO3900T	剥离器	160×3, 圆刃, 带吸引	1	把
15	ZO3901RB	耳用骨凿	175×3,枪状	1	把
16	ZO3902RB	耳用骨凿	175×2,枪状	1	把
17	ZO3903RB	耳钩	165×2, 直形, 锐钩	1	把
18	ZO3904T	剥离器	165×Φ1.5×10×90°, 带吸引	1	把
19	ZO3906RB	吸引管	135×Φ1.5, 下弯, 耳用	1	把
20	ZO3909RB	吸引管	140×Φ1.5, 下弯, 耳用	1	把
21	ZO3911RB	耳刮匙	160×2.5×3, 弯, 双头, 椭圆头	1	把
22	ZO3916RNh	快装手柄	空心, 快换	1	把

序号	产品编码	产品名称	规格型号	数量	单位
23	ZO3917RB	耳钳	80×0.5×0.8,直, 橄榄形	1	把
24	ZO3918RB	耳钳	80×3×30°, 下弯, 麦粒形	1	把
25	ZO3919RB	耳钳	80×1.2×45°, 下弯, 碗形	1	把
26	ZO3920RB	乳突咬骨钳	100×2	1	把
27	ZO872R	吸引管	75×Φ1.5, 耳用	1	把
28	ZO873R	吸引管	75×Φ2, 耳用	1	把
29	ZO882R	吸引管	75×Φ0.8, 耳用	1	把
30	ZO884R	吸引管	75×Φ2.5, 耳用	1	把

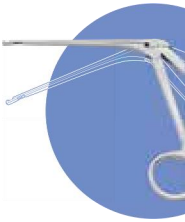

耳鼻喉科
Ear, Nose and Throat Instruments



BDQ- I 型鼻窦专用手术器械明细表 (ZO1000)
BDQ-I nasal surgical instruments set

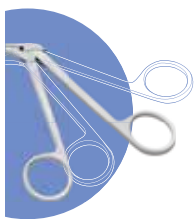

耳鼻喉科
Ear, Nose and Throat Instruments

序号	编码	名称	规格	单位	数量
1	ZO555RN	鼻组织剪	120, 管式, 直形	把	1
2	ZO556RN	鼻组织剪	120, 管式, 左弯	把	1
3	ZO557RN	鼻组织剪	120, 管式, 右弯	把	1
4	ZO558RN	鼻咬切钳	120×1.5, 盖板式, 直型, 正切	把	1
5	ZO559RN	鼻咬切钳	120×2, 盖板式, 直型, 反切	把	1
6	ZO3500RN	鼻组织钳	120×3, 盖板式, 直, 尖圆头	把	1
7	ZO3576RN	鼻组织钳	120×3, 盖板式, 角弯, 30°尖圆头	把	1
8	ZO3502RN	鼻组织钳	120×3, 盖板式, 角弯, 45°尖圆头	把	1
9	ZO3505RN	鼻组织钳	120×4, 盖板式, 角弯, 90°尖圆头	把	1
10	ZO574RN	鼻组织钳	120×4, 盖板式, 直, 长圆头	把	1
11	ZO517RN	鼻咽活体取样钳	140×70°, 管式, 角弯, 长圆头, 横开	把	1
12	ZO519RN	鼻咽活体取样钳	140×100°, 管式, 角弯, 长圆头, 横开	把	1
13	ZO516RN	鼻咽活体取样钳	140×70°, 管式, 角弯, 长圆头, 竖开	把	1
14	ZO514RN	鼻咽活体取样钳	140, 直形, 管式, 长圆头, 竖开	把	1
15	ZO581RN	鼻咽活体取样钳	150×3, 直形, 管式, 左开口	把	1
16	ZO582RN	鼻咽活体取样钳	150×3, 直形, 管式, 右开口	把	1
17	ZO586RN	鼻咽活体取样钳	170×3×90°, 角弯, 管式带吸	把	1
18	ZO311RN	上颌窦咬骨钳	150×4, 上切口	把	1
19	ZO588RN	鼻咬切钳	120×3, 盖板式, 直型, 长圆头, 鼻开筛	把	1
20	ZO590RN	鼻咬切钳	120×3×30°, 盖板式, 角弯, 长圆头, 鼻开筛	把	1

序号	编 码	名 称	规 格	单 位	数 量
21	ZO591RN	鼻腔吸引管	150×Φ3×24, 弯	支	1
22	ZO532RN	鼻腔吸引管	130×Φ2.5×55°×78	支	1
23	ZO592RN	鼻腔吸引管	130×Φ3×55°×78	支	1
24	ZO533RN	鼻腔吸引管	130×Φ4×55°×78	支	1
25	ZO523RN	鼻刮匙	190×4.5, 单头, 角弯, 匙形	支	1
26	ZO1010RN	鼻刮匙	190×4.5, 角弯15°, 碗形, 有孔	支	1
27	ZO593RN	鼻骨膜剥离器	190×4.5, 单头, 微弯	支	1
28	ZO594RN	鼻粘膜刀	180, 镰状尖	支	1
29	ZO595RN	鼻粘膜刀	180, 镰状圆	支	1
30	ZO598RN	鼻穿刺针	170×Φ4, 斜口	支	1

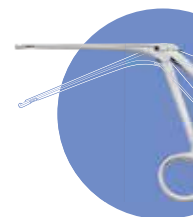

耳鼻喉科
Ear, Nose and Throat Instruments



鼻科专用器械套装 (ZO3658)
Nasal instruments set

序号	产品编码	产品名称	规格型号	数量	单位
1	ZO3640RB	鼻组织钳	130×3.5, 管式, 直, 尖头	1	把
2	ZO3641RB	鼻组织钳	130×3.5×30°, 管式, 角弯, 尖头	1	把
3	ZO3642RB	鼻组织钳	130×3.5×45°, 管式, 角弯, 尖头	1	把
4	ZO3643RB	鼻组织钳	140×3.5, 管式, 上弯, 115°, 尖头	1	把
5	ZO3644RB	鼻组织钳	135×3.5, 管式, 上弯, 90°, 尖头	1	把
6	ZO3645RB	鼻组织钳	140×3.5, 管式, 下弯, 115°, 尖头	1	把
7	ZO3646RB	鼻组织钳	135×3.5, 管式, 下弯, 90°, 尖头	1	把
8	ZO3647RB	鼻咬切钳	130×3, 管式, 直型, 尖头	1	把
9	ZO3648RB	鼻咬切钳	130×3×30°, 管式, 角弯, 尖头	1	把
10	ZO3649RB	鼻咬切钳	130×3×45°, 管式, 角弯, 尖头	1	把
11	ZO3650RB	鼻咬切钳	130×3, 管式, 直型, 长圆头	1	把
12	ZO3651RB	鼻咬切钳	130×3×30°, 管式, 角弯, 长圆头	1	把
13	ZO3652RB	鼻咬切钳	130×3×45°, 管式, 角弯, 长圆头	1	把
14	ZO3653RB	鼻咬切钳	130×1.8, 管式, 直型, 反切	1	把
15	ZO3654RB	鼻咬切钳	130×2.5, 管式, 直型, 反切	1	把
16	ZO3655RB	鼻组织剪	130, 直形, 管式	1	把
17	ZO3656RB	鼻组织剪	130, 左弯, 管式	1	把
18	ZO3657RB	鼻组织剪	130, 右弯, 管式	1	把

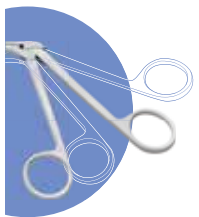

耳鼻喉科
Ear, Nose and Throat Instruments

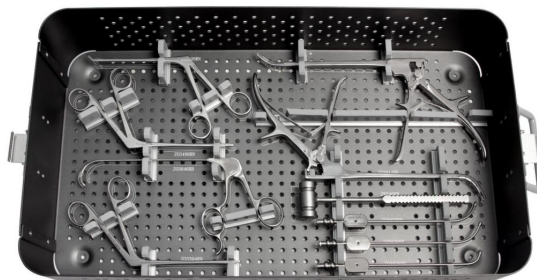
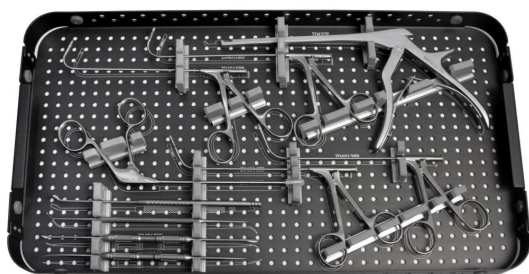
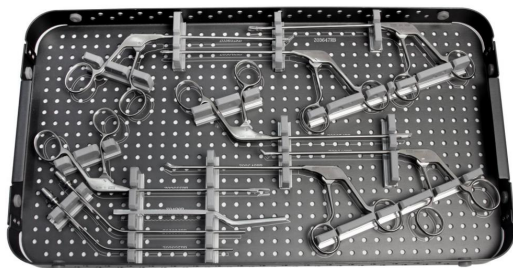

鼻内镜手术器械包 (ZO4027)

Functional endoscopic sinus surgery FESS instruments set(ZQ4027)

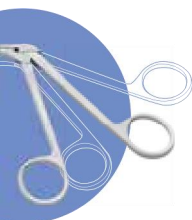

耳鼻喉科
Ear, Nose and Throat Instruments

序号	产品编码	产品名称	规格型号	数量	单位
1	ZK046RN	骨锤	180/70g	1	把
2	ZO3394RN	鼻咬切钳	120×3, 盖板式, 直型, 长圆头	1	把
3	ZO3498RN	鼻组织钳	120×3, 盖板式, 直, 长圆头	1	把
4	ZO3499RN	鼻组织钳	120×3, 盖板式, 角弯, 45°, 长圆头	1	把
5	ZO3640RB	鼻组织钳	130×3.5, 管式, 直, 尖头	1	把
6	ZO3642RB	鼻组织钳	130×3.5×45°, 管式, 角弯, 尖头	1	把
7	ZO3646RB	鼻组织钳	135×3.5, 管式, 下弯, 90°, 尖头	1	把
8	ZO3647RB	鼻咬切钳	130×3, 管式, 直型, 尖头	1	把
9	ZO3648RB	鼻咬切钳	130×3×30°, 管式, 角弯, 尖头	1	把
10	ZO3650RB	鼻咬切钳	130×3, 管式, 直型, 长圆头	1	把
11	ZO3652RB	鼻咬切钳	130×3×45°, 管式, 角弯, 长圆头	1	把
12	ZO3654RB	鼻咬切钳	130×2.5, 管式, 直型, 反切	1	把
13	ZO3655RB	鼻组织剪	130, 直形, 管式	1	把
14	ZO3835RB	鼻腔吸引管	170×Φ2.5, 可控	1	把
15	ZO3836RB	鼻腔吸引管	170×Φ3, 可控	1	把
16	ZO3838RB	鼻腔吸引管	175×Φ2.5, 可控, 60°	1	把
17	ZO3839RB	鼻腔吸引管	175×Φ3, 可控, 60°	1	把
18	ZO3859RB	鼻腔吸引管	175×Φ3, 可控, 70°	1	把
19	ZO3943RB	蝶窦咬骨钳	170×30°×3	1	把
20	ZO3944RB	蝶窦咬骨钳	170×70°×3	1	把
21	ZO4013RB	鼻咽活体取样钳	130×65°, 管式, 角弯, 长圆头, 竖开	1	把
22	ZO4014RB	鼻咽活体取样钳	130×65°, 管式, 角弯, 长圆头, 横开	1	把

序号	产品编码	产品名称	规格型号	数量	单位
23	ZO4015RB	鼻咽活体取样钳	130×110°, 管式, 角弯, 长圆头, 竖开	1	把
24	ZO4016RB	鼻咽活体取样钳	130×110°, 管式, 角弯, 长圆头, 横开	1	把
25	ZO4017RB	鼻粘膜刀	195×3.5×4.5, 双头	1	把
26	ZO4023RB	鼻骨膜剥离器	200×4.5×4.5, 双头	1	把
27	ZO420R	鼻中隔凿	160×4, 枪形, 鱼尾	1	把
28	ZO432R	蝶窦咬骨钳	180×135°×3, 上切口, 直型	1	把
29	ZO439RN	上颌窦探针	190×1×2, 角弯	1	把
30	ZO523RN	鼻刮匙	190×4.5, 单头, 角弯, 匙形	1	把

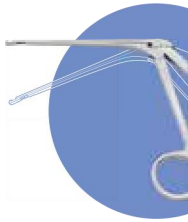

耳鼻喉科
Ear, Nose and Throat Instruments



BQC-I 型扁桃体切除手术器械包 Z0680
BQC-I Tonsillectomy instruments set

序号	产品编码	产品名称	规格型号	数量	单位
1	ZB077R	手术刀柄	7#	1	把
2	ZO707R	扁桃体剪	180, 弯型	1	把
3	ZE017R	组织钳	180, 直	2	把
4	ZH957R	止血钳	200×R50×9×2.5, 圆弯头, 扁桃体	1	把
5	ZH956R	止血钳	180×R50×9×2.5, 圆弯头, 扁桃体	1	把
6	ZH958R	止血钳	220×R50×9×2.5, 圆弯头, 扁桃体	1	把
7	ZO671R	扁桃体用钳	220, 三爪, 直形	1	把
8	ZM236R	持针钳	180, 直, 粗针	1	把
9	ZE433R	帕巾钳	140, 尖头	2	把
10	ZO662RN	扁桃体拉钩	225, 双头, 扁桃体拉钩及剥离子	1	把
11	ZO710R	扁桃体切除器	260, 直形, 圈断器	1	把
12	ZO706R	扁桃体切除器	Φ0.4×10, 圈断器钢丝	1	把
13	ZR813R	口腔开口器	麻醉, 左式	1	把
14	ZH954R	海绵钳	180×12, 弯有齿, 扁桃体	1	把
15	ZE117R	海绵钳	250×8, 弯有齿	1	把
16	ZO611R	压舌板	120, 直角形	1	把
17	ZO673R	扁桃体吸引管	280, 管径 Φ6	1	把
18	ZO136R	吸引管	190×Φ4, 弯, 乳突	1	把
19	ZD053R	医用镊	220, 直	1	把
20	ZO677RN	鼻刮匙	220×15, 无钩, 鼻增殖体刮匙	1	把
21	ZO398RN	鼻刮匙	220×12, 无钩, 鼻增殖体刮匙	1	把

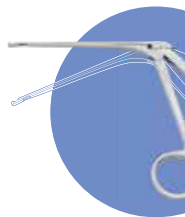

耳鼻喉科
Ear, Nose and Throat Instruments



HX- III型喉科显微外科手术器械包 (ZO1400)
HX-III Throat instruments set

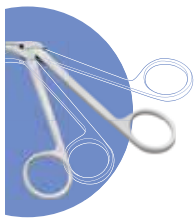

耳鼻咽喉科
Ear, Nose and Throat Instruments

序号	产品编码	产品名称	规格型号	数量	单位
1	ZO3823RB	显微喉钳	230×2, 管式, 直型, 圆头	1	把
2	ZO3824RB	显微喉钳	230×2, 管式, 上弯, 圆头	1	把
3	ZO3825RB	显微喉钳	230×2, 管式, 左弯, 圆头	1	把
4	ZO3826RB	显微喉钳	230×2, 管式, 右弯, 圆头	1	把
5	ZO3827RB	显微喉钳	230×2, 管式, 直型, 有齿	1	把
6	ZO3828RB	显微喉钳	230×2, 管式, 上弯, 45°, 有齿	1	把
7	ZO3829RB	显微喉钳	230×2.2, 管式, 直型, 三角头	1	把
8	ZO3830RB	显微喉钳	230×2.2, 管式, 上弯, 45°, 三角头	1	把
9	ZO3831RB	显微喉钳	230×2, 管式, 直型, 卵圆型	1	把
10	ZO3832RB	显微喉钳	230×2, 管式, 上弯, 卵圆型	1	把
11	ZO3833RB	显微喉钳	230×2, 管式, 左弯, 卵圆型	1	把
12	ZO3834RB	显微喉钳	230×2, 管式, 右弯, 卵圆型	1	把
13	ZO1241RB	显微喉剪	250, 管式, 直型	1	把
14	ZO1242RB	显微喉剪	250×45°, 管式, 上弯	1	把
15	ZO1243RB	显微喉剪	250, 管式, 右弯	1	把
16	ZO1244RB	显微喉剪	250, 管式, 左弯	1	把
17	ZO3846RB	显微喉刀	245, 直形, 镰刀	1	把
18	ZO3847RB	显微喉刀	245, 直形, 三角刃	1	把
19	ZO3848RB	显微喉刀	245, 直形, 圆刃	1	把
20	ZO3849RB	显微喉刀	245, 角弯, 圆刃	1	把
21	ZO3850RB	显微喉刀	245, 直形, 圆刃	1	把
22	ZO3851RB	显微喉钩	245, 圆弯	1	把

序号	产品编码	产品名称	规格型号	数量	单位
23	ZO3852RB	剥离器	245, 圆头, 微弯	1	把
24	ZO3853RB	结扎缝合引线器	245	1	把
25	ZO3854RB	显微喉针	245, 直型, 球头	1	把
26	ZO3855RB	显微喉针	245, 角弯, 45°, 球头	1	把
27	ZO3856RB	显微喉针	245, 角弯, 90°, 球头	1	把
28	ZO3857RB	喉显微手术器械手柄	与喉钩、喉刀、喉针配用, 可换	1	把
29	ZO1276RN	吸引管	275×Φ2.5, 弯, 喉用, 可控	1	把
30	ZO1277RN	吸引管	275×Φ3, 弯, 喉用, 可控	1	把
31	ZO1278RN	吸引管	275×Φ3.5, 弯, 喉用, 可控	1	把
32	ZO1279RN	吸引管	275×Φ4, 弯, 喉用, 可控	1	把
33	ZO1201RN	支撑喉镜	支撑架	1	把
34	ZO1202RN	支撑喉镜	大号	1	把
35	ZO1203RN	支撑喉镜	小号	1	把
36	ZO1221RN	支撑喉镜	带光纤	1	把

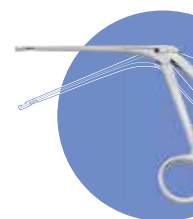

耳鼻喉科
 Ear, Nose and Throat Instruments

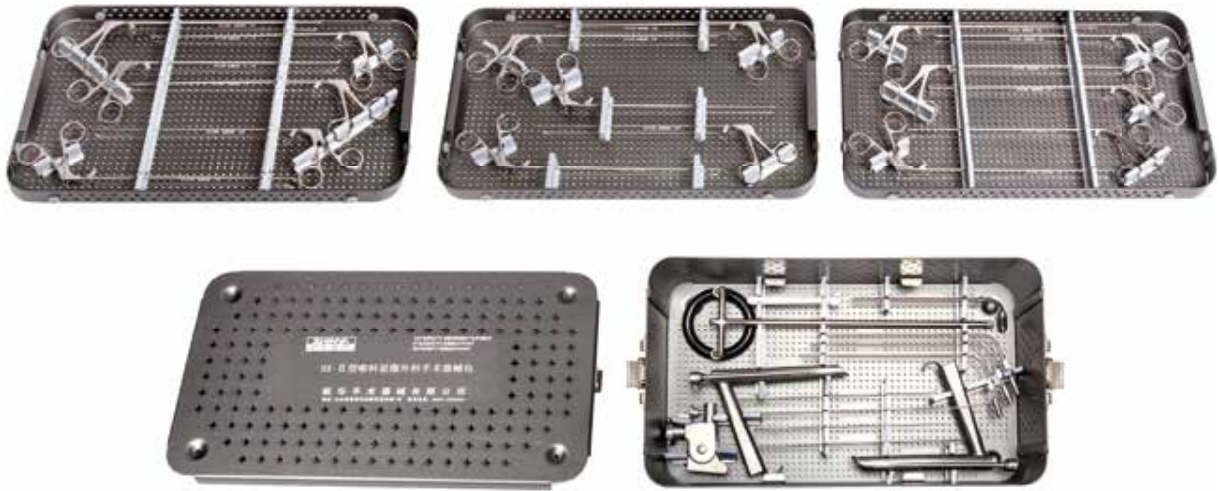

HX- II 型喉科显微外科手术器械包ZO1225
HX- II type Throat surgical instruments

序号	编码	名称	规格	单位	数量
1	JO1180RB	显微喉钳	230×φ2, 管式, 直型, 圆头	把	1
2	JO1181RB	显微喉钳	230×φ2, 管式, 上弯, 圆头	把	1
3	JO1182RB	显微喉钳	230×φ2, 管式, 右弯, 圆头	把	1
4	JO1183RB	显微喉钳	230×φ2, 管式, 左弯, 圆头	把	1
5	JO1184RB	显微喉钳	230×1, 管式, 直型, 麦粒形	把	1
6	JO1185RB	显微喉钳	230×1, 管式, 右弯, 麦粒形	把	1
7	JO1186RB	显微喉钳	230×1, 管式, 左弯, 麦粒形	把	1
8	JO1187RB	显微喉钳	230×1, 管式, 上弯, 麦粒形	把	1
9	JO1188RB	显微喉钳	230×3, 管式, 角弯, 右弯, 抓取型	把	1
10	JO1189RB	显微喉钳	230×2, 管式, 角弯, 右弯, 抓取型	把	1
11	JO1190RB	显微喉钳	230×3, 管式, 角弯, 左弯, 抓取型	把	1
12	JO1191RB	显微喉钳	230×2, 管式, 角弯, 左弯, 抓取型	把	1
13	JO1249RB	显微喉剪	230, 管式, 直型	把	1
14	JO1250RB	显微喉剪	230×45°, 管式, 上弯	把	1
15	JO1251RB	显微喉剪	230×15°, 管式, 上弯	把	1
16	JO1252RB	显微喉剪	230, 管式, 右弯	把	1
17	JO1253RB	显微喉剪	230, 管式, 左弯	把	1
18	ZO1201RN	支撑喉镜	支撑架	件	1
19	ZO1202RN	支撑喉镜	大号	件	1
20	ZO1203RN	支撑喉镜	小号	件	1
21	ZO1221RN	支撑喉镜	带光纤	件	1
22	ZO1270RN	吸引管	250×φ3, 弯, 喉用, 可控	把	1
23	ZO1271RN	吸引管	250×φ3.5, 弯, 喉用, 可控	把	1
24	ZO1272RN	吸引管	250×φ4, 弯, 喉用, 可控	把	1
25	ZO724RN	显微喉针	250, 角弯	把	1
26	ZO725RN	显微喉刀	250, 三角刀, 直形	把	1
27	ZO727RN	显微喉钩	250, 圆弯, 双爪	把	1
28	ZO767RN	显微喉刀	250, 镰刀, 直形	把	1
29	ZO768RN	喉显微手术器械手柄 与喉钩、喉刀、喉针配用, 可换		把	1

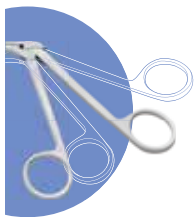

耳鼻喉科
Ear, Nose and Throat Instruments